

Tracing Ellen's mtDNA

Tracing Ellen's mtDNA

Craig Rhombs

Tracing Ellen's mtDNA

Table of Contents

Change log.....	6
Objective.....	7
The Family of John and Ellen Thompson.....	8
Hannah Thompson Moulthrop b. 1643 d. 1681.....	10
Hannah Moulthrop Russell b. 1665 d. 1713.....	11
Hannah Russell Gregory b. 1689 d. 1751.....	12
Lydia Russell Utter b. 1692 d. 1750.....	12
Lydia Utter Welton b. 1718 d. 1750.....	12
Mary Utter b. 1727 d. 1728.....	12
Sarah Utter b. 1730 d. 1731?.....	12
Abigail Russell Hodges b. 1701 d. ?.....	13
Abigail Hodges b. 1732 d.?.....	13
Rachel Russell Brewster b. 1703 d. ?.....	14
Mabel Russell Utter b. 1706 d. 1782.....	14
Sarah Russell Shepard b. 1711 d. ?.....	14
Sarah Shepard Chidsey b. 1728 d. 1783.....	15
Hannah Chidsey b. 1747 d. ?.....	15
Sarah Chidsey b. 1758 d. ?.....	15
Rhoda Chidsey b. 1764 d. 1820?.....	15
Mary Chidsey Curtis b. 1765 d. ?.....	16
Eunice Chidsey Walker b. 1768 d. ?.....	16
Mary Shepard b. 1731 d. 1743.....	17
Elizabeth Shepard Hotchkiss b. 1734 d. 1819.....	17
Mary Shepard b. 1746 d.?.....	17
Huldah Shepard Townsend b. 1755.....	18
Kezia Moulthrop Barker b. 1682 d. 1767.....	19
Hannah Barker Rose b. 1707 d. 1785.....	20
Kezia Barker Smith b. 1710 d. 1793.....	20
Lydia Barker Palmer b. 1712 d. 1781.....	21
Thankful Barker Rose b. 1719 d. 1791.....	22
Abigail Thompson Alsop Miles b. 1651 d. 1727.....	23
Rebecca Thompson Thomas b. 1651 d. 1716.....	25
Dorothy Thomas Tolles b. 1674 d. 1727.....	26
Experience Tolles Osborne b. 1694 d. 1737.....	26
Esther Osborne Booth b. 1721 d. ?.....	27
Rachel Tolles Ruggles b. 1710 d. 1746.....	28
Lois Ruggles Warner b. 1721 d. 1781.....	28
Rachel Ruggles Bishop b. 1732 d. 1800.....	29
Mercy Ruggles Bostwick b. 1732 d. 1822.....	30
Mabel Ruggles Bostwick b. 1736 d. 1804.....	31
Dorothy Tolles Bristol b. 1711 d. 1785.....	32

Tracing Ellen's mtDNA

Rachel Bristol Smith Downs b. 1739 d. 1817.....	32
Dorothy Bristol Thomas b. 1748 d. 1834.....	32
Dinah Bristol Candee b. 1751 d. 1785.....	32
Mary Tolles b. 1730 d. 1731?.....	33
Dinah Thomas Sherman b. 1678 d. 1769.....	34
Lydia Sherman Todd b. 1699 d. 1733.....	35
Lydia Todd Smith b. 1727 d. 1819.....	35
Lois Todd Turner b. 1729 d. 1812.....	36
Eunice Todd Gilbert b. 1732 d. 1832.....	37
Dinah Sherman Atwater b. 1702 d. 1739.....	38
Abigail Atwater Peck b. 1727 d. ?.....	39
Lydia Atwater b. 1734 d. 1748?.....	40
Rachel Atwater Bradley b. 1737 d. 1809.....	40
Elizabeth Sherman Gilbert b. 1708 d. 1738.....	41
Sarah Gilbert Potter b. 1730 d. 1798.....	41
Recompence Thomas b. 1683 d. 1703.....	43
Experience Thomas b. 1687 d. 1703.....	43
Mary Thompson Cooper b. 1652 d. ? *.....	44
Sarah Cooper Munson b. 1673 d. 1736.....	45
Hannah Munson Andrews b. 1697 d. 1785.....	45
Amy Munson Sperry b. 1704 d. ?.....	45
Rebecca Sperry Osborn b. 1730 d. ?.....	45
Amy Sperry b. 1732 d. 1748.....	46
Phebe Sperry Downs b. 1735 d. ?.....	46
Thankful Sperry b. 1740 d. 1740?.....	46
Ruth Munson Hotchkiss b. 1708 d. 1785.....	47
Esther Hotchkiss Murray b. 1745 d. 1831.....	47
Mehitabel Munson Morris b. 1709.....	48
Sarah Morris b. 1737 d. 1829?.....	48
Elizabeth Morris Humpreville b. 1739 d. ?.....	48
Sarah Munson Stone b. 1713 d. 1737.....	49
Elizabeth Stone b. 1735 d. ?.....	49
Elizabeth Munson Perkins b. 1695 d. ?.....	49
Amy Perkins Peck b. 1726 d. 1799.....	49
Eleanor Perkins Hotchkiss b. 1726 d. 1816.....	49
Mary Cooper Smith b. 1677 d. 1761 *.....	50
Obedience Smith b. 1705 d. 1705.....	50
Mary Smith Painter b. 1707 d. 1786.....	51
Mary Painter Mallory b. 1728 d. 1804.....	51
Amy Painter b. 1730 d. 1751.....	52
Abigail Painter b. 1738 d. 1755.....	52
Rebecca Painter b. 1744 d. 1788.....	52
Freelove Painter b. 1749 d. 1751.....	52

Tracing Ellen's mtDNA

Amy Smith b. 1709 d. ?.....	53
Margaret Smith Smith(!) b. 1711 d. 1803 *.....	53
Margaret Smith Thompson b. 1734 d. 1821.....	53
Mary Smith (Thompson?) b. 1737 d. 1773.....	54
Hannah Smith Hickox b. 1746/1747 d. ?.....	54
Philena Smith Hickox b. 1750 d. 1826 *.....	55
Sarah Hickox Beebe b. 1774 d. 1864.....	55
Polly Hickox Warner b. 1777 d. 1849 *.....	55
Hannah Smith Hickox Terrill b. 1781 d. 1856.....	56
David Hickox b. 1772 d. 1847.....	56
Mehitabel Smith Benham b. 1755 d. 1834.....	57
Thankful Smith Tolles b. 1712 d. 1769.....	58
Thankful Tolles Sanford b. 1737 d. 1820.....	59
Dorothy Tolles b. 1745 d. 1745?.....	60
Desire Tolles Beecher b. 1745 d. 1812.....	60
Mary Tolles Thomas b. 1756 d. 1842.....	60
Abigail Cooper Johnson b. 1679 d. 1724.....	61
Eunice Johnson (Sperry?) b. 1703 d. 1725.....	61
Hannah Cooper Lines b. 1681 d. 1772.....	62
Kezia Lines Alling b. 1715 d. 1782.....	63
Ruth Alling Hine b. 1738 d. 1777.....	63
Kezia Alling b. 1748 d. 1765.....	64
Eleanor Alling Frisbie b. 1751 d. ?.....	64
Hannah Alling Peck b. 1751 d. ?.....	64
Rebecca Cooper Alling b. 1689 d. 1770.....	65
Phebe Alling Talmadge Wolcott b. 1723 d. 1788.....	65
Phebe Wolcott Barney b. 1755 d. 1832.....	66
Rebecca Wolcott Turner b. 1759 d. 1838.....	66
Sarah Thompson Alling b. 1654 d. 1716.....	67
Undocumented Lines (Dead-ends).....	68
Along Hannah Thompson's Line.....	68
The daughters of Mabel Russell and Benjamin Utter.....	68
Sarah Utter (b.1730), daughter of Lydia Russell (b. 1692) and Abraham Utter (b. 1688).....	69
Abigail Hodges (b. 1731), daughter of Abigail Russell (b. 1701) and Abraham Hodges (b. 1697)	69
.....	69
First Daughter of Sarah Shepard Chidsey (b.1728), Hannah Chidsey (b. 1747).....	70
Sarah Chidsey (b. 1758), daughter of Sarah Shepard (b. 1728) and John Chidsey (b. 1720).....	70
Rhoda Chidsey (b. 1764), daughter of Sarah Shepard (b. 1728) and John Chidsey (b. 1720).....	70
Mary Shepard's Identity(ies).....	71
Esther Palmer (b. 1751), daughter of Lydia Barker Palmer (b. 1712).....	71
Along Rebecca Thompson's Line.....	72
Elizabeth / Betsy Booth b. 1753.....	72
Sarah Gilbert (1758-?).....	72

Tracing Ellen's mtDNA

Mary Peck b. 1758 d. ?.....	72
Pamela Peck b. 1761 d. ?.....	72
Mary Dinah Peck b. 1767.....	72
Along Mary Thompson's Line.....	73
Elizabeth Stone b. 1735 d. ?.....	73
Mary (1757? -?), the Daughter of Ruth Alling Hine b. 1738 d. 1777.....	73
Eunice Johnson (Sperry?) b. 1703 d. 1725.....	73
Rebecca Painter (Sherman?) b. 1744 d. 1788.....	73
Amy Smith b. 1709 d. ?.....	74
Mary Smith (Thompson?) b. 1737 d. 1773.....	74
Descendants of Ellen Thompson and John Thompson – until 1800 +/-.....	75

Note: the * in the table of contents entries indicates my direct maternal line. The headings for these sections are also highlighted in yellow below.

Tracing Ellen's mtDNA

Change log

rev. 01, 2/9/2019: This version reflects the completion of an analysis of the female descendants of Hannah Thompson Moulthrop through roughly 1800. I added a section to summarize "Undocumented Lines (Dead-ends)". This is where I am collecting a list of research problems that may indicate that more individuals might be found if the problems can be solved.

Rev. 02, 2/10/2019: Information added for Abigail Thompson Alsop and Kezia Moulthrop Barker's lines.

Rev. 02, 2/12/2019: Finished Sarah Thompson's line.

Rev. 03, 2/22/2019: Finished all Thompson lines. This is the first complete draft.

Rev. 04, 2/24/2019: Revised information about Elizabeth Booth, daughter of Esther Osborn Booth. Death information looks very shaky, so turned her death date and location to unknown. Updated info for Lydia Todd Smith – I had missed her daughter Mary (b. 1747).

Rev. 05 3/17/2019: Added information along Mary Pinter's line in an effort to extend that line to provide a proposed connection to a mtDNA cousin. (See the section on Mary Painter Mallory.) I also updated the descendant report at the end of this document.

Tracing Ellen's mtDNA

Objective

Test results from familytreedna.com indicate that my mtDNA is a close match to that of about a dozen people. Taking heteroplasmy into account, some of these may effectively be exact matches. The purpose of the work documented here is to investigate one line of reasoning that might help to identify our most recent common ancestor, who likely lived a few hundred years ago.

There is a chance that our most recent common maternal ancestor existed in the American Colonies. Tracing the female descendants of my first maternal-line female ancestor to appear in colonial records might then identify the common ancestor if others can drive their family trees far enough back in time.

I am lucky to have had the assistance of one of the people with matching mtDNA. This person has traced her maternal line back to Fairfield Co., CT, in the late 1700s, but there is a roadblock at that point. My maternal line starts in the area of New Haven Co., CT, and I have a clear trail of linked ancestors leading back to myself. Perhaps this work will help break the roadblock and help us to determine if our most recent common maternal ancestor lived in England or the American Colonies.

So, this is a description of a quest to identify all direct-line female descendants of a lady probably named Ellen, who lived in Colonial Connecticut. I have not discovered her surname, but it seems that she married a man named John Thompson, and, after his death, she married a man named Thomas Harrison. The second marriage produced no female offspring, but her first marriage did yield female offspring.

By the way, I have found no hints about Ellen's ancestors. I assume that they were from England.

You will not find source references here. This is basically a birth/marriage/death document to establish existence. I am recording some source information in a family tree that I maintain. So, I think that you have to regard what follows as a current estimate, subject to errors and corrections. It is something to work from, not a polished final product.

Tracing Ellen's mtDNA

The Family of John and Ellen Thompson

Here is a family group chart . It illustrates that Ellen had five daughters, whose lines I trace below.

Family Group Report		
Husband: Thompson, John		
Birth	1617	England
Death	1656	
Father		
Mother		
Wife: unknown, Ellen		
Birth	speculation	
	1621	England
Death	1656-1666?	
		New Haven County, CT, Connecticut
Father		
Mother		
Children		
1M	Thompson, John Jr.	
	Birth	1641
	Death	1693-02-13
	Spouse	Powell, Priscilla
	Marriage	1666-05-22
2F	Thompson, Hannah	
	Birth	1643
	Death	1681
	Spouse	Moulthrop, Matthew
	Marriage	1662-06-26
3M	Thompson, Ebenezer	
	Birth	1648-10-15
	Death	1674
4M	Thompson, Joseph	
	Birth	1649
	Death	1703
	Spouse	Lathrop, Elizabeth
5F	Thompson, Abigail	
	Birth	1651-01-26
	Death	1727
	Spouse	Alsop, Joseph
	Marriage	1672-11-25
6F	Thompson, Rebecca	
	Birth	1651-01-26
	Death	1716
	Spouse	Thomas, Daniel
	Marriage	1669-02-03
7F	Thompson, Mary	
	Birth	1652-04-24
	Death	1714-11-00
	Spouse	Cooper, John Junior
	Marriage	1666-12-27
8F	Thompson, Sarah	
	Birth	1654-04-30
	Death	1716-10-23
	Spouse	Ball, Alling

Tracing Ellen's mtDNA

Here is a different view of Ellen's families, not just the one with John Thompson.

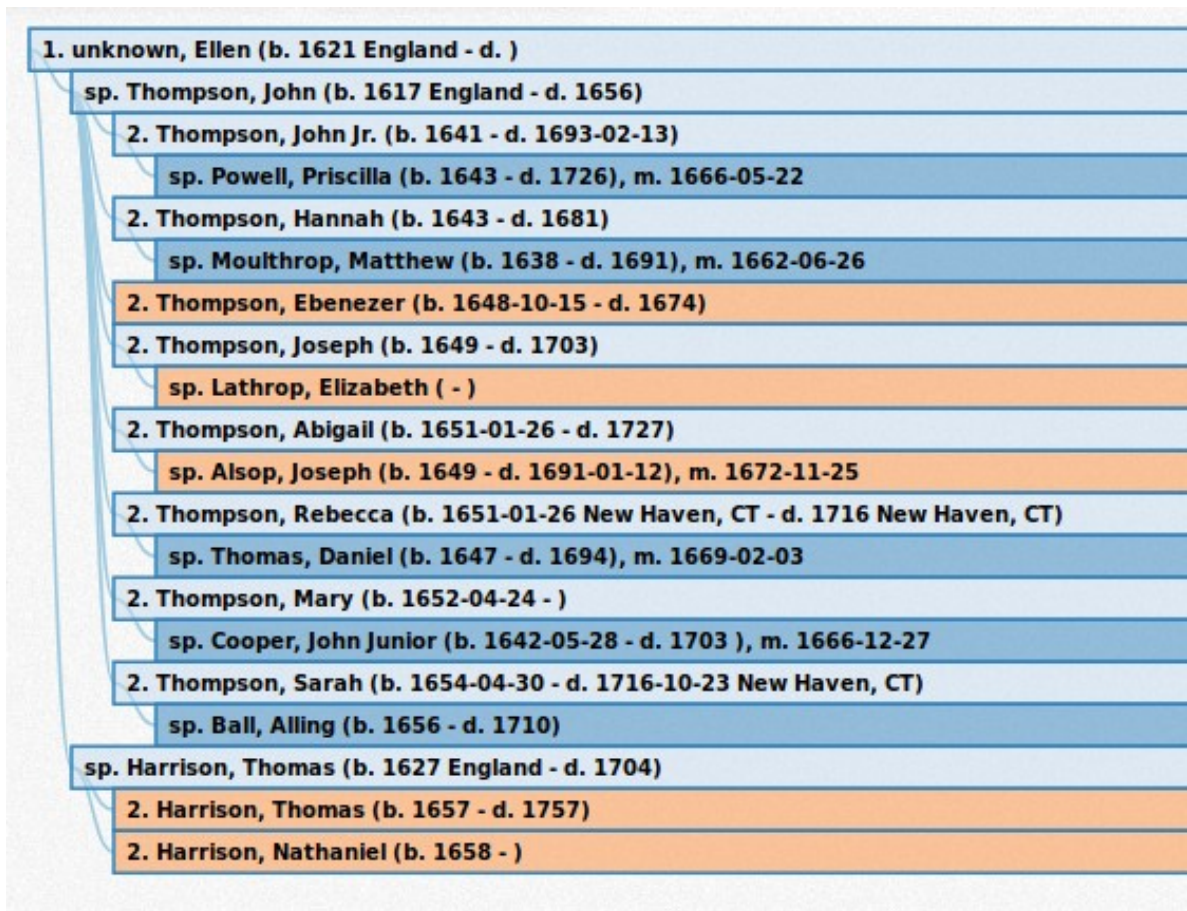

I am assuming (without concrete evidence) that John and Ellen were born in England at about the years shown.

Following this are best current estimates of the female descendants of Ellen's five daughters. (Note that her second marriage only yielded sons.) My objective is to document the estimated maternal lines into the late 18th century.

Tracing Ellen's mtDNA

Hannah Thompson Moulthrop b. 1643 d. 1681

Here is a depiction of two generations of Hannah's descendants.

Hannah has two daughters that potentially can further the mtDNA line – Hannah b. 1665 and Kezia/Keziah b.1682.

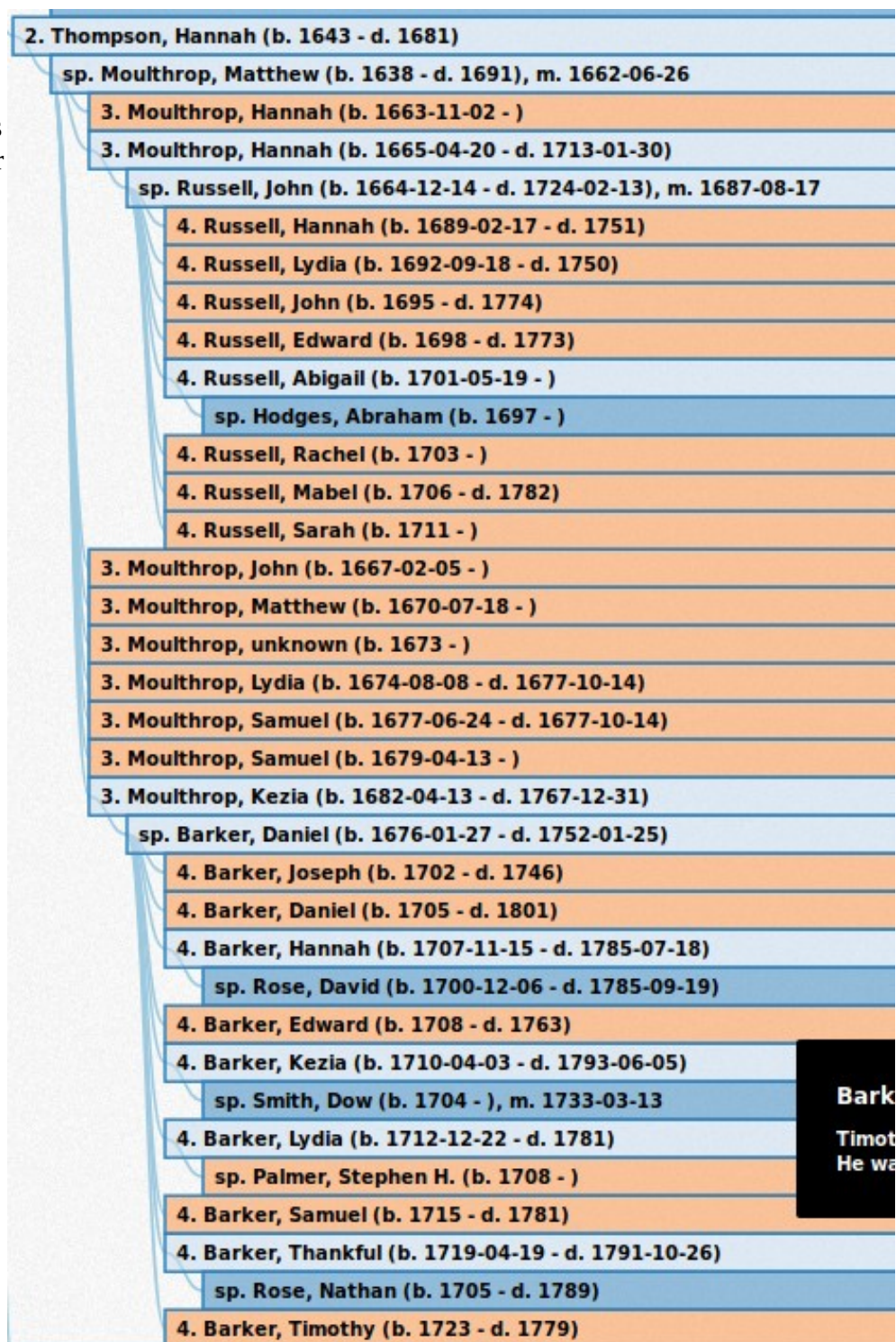

Tracing Ellen's mtDNA

Hannah Moulthrop Russell b. 1665 d. 1713

Hannah has the following daughters of interest –

Hannah Russell,

Lydia Russell,

Abigail Russell,

Rachel Russell,

Mabel Russell, and

Sarah Russell.

The screenshot shows a genealogy software interface. At the top, there are two profiles: 'Father/partner1' (John Russell, b. 1664-12-14, d. 1724-02-13) and 'Mother/partner2' (Moulthrop, Hannah [11498], b. 1665-04-20, d. 1713-01-30). Below this is the 'Relationship Information' section, showing ID: F0403 and Type: Married. A 'Tags' field is empty. The main part of the screenshot is a table titled 'Children' with columns: #, ID, Name, Gender, Paternal, Maternal, and Birth Date. The table lists eight children of John Russell.

#	ID	Name	Gender	Paternal	Maternal	Birth Date
1	I1548	Russell, Hannah	female	Birth	Birth	1689-02-17
2	I1555	Russell, Lydia	female	Birth	Birth	1692-09-18
3	I1556	Russell, John	male	Birth	Birth	1695
4	I1557	Russell, Edward	male	Birth	Birth	1698-04-19
5	I1558	Russell, Abigail	female	Birth	Birth	1701-05-19
6	I1559	Russell, Rachel	female	Birth	Birth	1703-12-15
7	I1560	Russell, Mabel	female	Birth	Birth	1706-07-14
8	I1561	Russell, Sarah	female	Birth	Birth	1711-02-23

Information about their female descendants follows.

Tracing Ellen's mtDNA

Hannah Russell Gregory b. 1689 d. 1751

It appears that Hannah and her husband, Joseph Gregory b.1674, had no daughters.

Lydia Russell Utter b. 1692 d. 1750

Lydia's candidate daughters are . . .

Lydia Utter b. 1718 d. 1750

Mary Utter b. 1727

Sarah Utter b. 1730

Information for each follows.

4. Russell, Lydia (b. 1692-09-18 - d. 1750)
sp. Utter, Abraham (b. 1688 - d. 1761), m. 1715-06-27
5. Utter, Abraham (b. 1716 - d. 1779)
5. Utter, Lydia (b. 1718-11-24 - d. 1750-08-21)
5. Utter, Samuel (b. 1720 -)
5. Utter, John (b. 1722 -)
5. Utter, Isaac (b. 1724 -)
5. Utter, Mary (b. 1727-11-24 -)
5. Utter, Sarah (b. 1730-07-03 -)
5. Utter, Jabez (b. 1733 -)

Lydia Utter Welton b. 1718 d. 1750

Findagrave.com entries indicate that this couple had no children.

Mary Utter b. 1727 d. 1728

The consensus based only on pedigree charts at familyserach.org is that Mary did not survive long. (Not strong evidence, but all that I can find at this time.)

Sarah Utter b. 1730 d. 1731?

There is conflicting information about the fate of Sarah. She may have died within a year of birth or she may have married Phillip Knight of Rhode Island, where she died in 1759, after having two daughters – Phebe (b. 1756) and Sarah (b. 1757). Requires more careful research to get a better idea of the truth.

Tracing Ellen's mtDNA

Abigail Russell Hodges b. 1701 d. ?

Abigail had just one daughter, also named Abigail b. 1732. I need to investigate any family(ies) that she may have had.

Name: Hodges, Abraham [11572]	Name: Russell, Abigail [11558]					
Birth: 1697	Birth: 1701-05-19					
Death:	Death:					
Relationship Information						
ID: <input type="text" value="F0411"/>	Type: <input type="text" value="Married"/>					
Tags:						
Children Events Source Citations Attributes Notes Gallery LDS						
+ 📄 📝 - 📶 📵						
#	ID	Name	Gender	Paternal	Maternal	Birth Date
1	I1610	Hodges, Isaac	male	Birth	Birth	1729
2	I1611	Hodges, Abraham	male	Birth	Birth	1726
3	I1612	Hodges, Abigail	female	Birth	Birth	1732
4	I1613	Hodges, David	male	Birth	Birth	1733
5	I1614	Hodges, Samuel	male	Birth	Birth	1736

Abigail Hodges b. 1732 d.?

I can find no records other than a birth record for Abigail Hodges of the New Haven / Waterbury area.

Tracing Ellen's mtDNA

Rachel Russell Brewster b. 1703 d. ?

It appears that Rachel and her husband, William Brewster, had no daughters. They probably moved to Dutchess Co., NY, from CT.

Mabel Russell Utter b. 1706 d. 1782

Mable and Benjamin appear to have had two daughters, Mary b. 1737 and Mabel b. 1765. I have found no records of marriages for these daughters, who were born quite far apart in time.

Sarah Russell Shepard b. 1711 d. ?

Sarah Russell appears to have had five daughters with her husband, John Shepard b. 1696.

Sarah Shepard (married
to John Chidsey)

Mary Shepard

Elizabeth Shepard
(married to Enos
Hotchkiss)

Mary Shepard

Huldah Shepard
(married to Elias
Townsend)

Father/partner1		Mother/partner2				
Name:	Shepard, John [I1654]	Name:	Russell, Sarah [I1561]			
Birth:	1696-08-09	Birth:	1711-02-23			
Death:	1780-05-18	Death:	1761-01-01			
Relationship Information						
ID:	F0423	Type:	Married			
Tags:						
Children Events Source Citations Attributes Notes Gallery LDS						
#	ID	Name	Gender	Paternal	Maternal	Birth Date
1	I1655	Shepard, Sarah	female	Birth	Birth	1728-03-11
2	I1656	Shepard, Mary	female	Birth	Birth	1731-09-13
3	I1657	Shepard, Elizabeth	female	Birth	Birth	1734-07-20
4	I1658	Shepard, John	male	Birth	Birth	1736
5	I1659	Shepard, Stephen	male	Birth	Birth	1740
6	I1660	Shepard, John	male	Birth	Birth	1743
7	I1661	Shepard, Mary	female	Birth	Birth	1746-09-30
8	I1662	Shepard, Levi	male	Birth	Birth	1753
9	I1663	Shepard, Huldah	female	Birth	Birth	1755-11-25

Tracing Ellen's mtDNA

Sarah Shepard Chidsey b. 1728 d. 1783

Sarah and John had the following daughters. -



Hannah

Sarah

Rhoda

Mary

Eunice

Father/partner1  **Mother/partner2** 







Name: Chidsey, John [I1665] Birth: 1720-09-15 Death: 1783-09-17

Name: Shepard, Sarah [I1655] Birth: 1728-03-11 Death: 1783-06-01

Relationship Information

ID: F0425 Type: Married

Tags:

Children      

#	ID	Name	Gender	Paternal	Maternal	Birth Date
1	I1666	Chidsey, Hannah	female	Birth	Birth	1740-05-06
2	I1667	Chidsey, John	male	Birth	Birth	1749-12-16
3	I1668	Chidsey, Ephraim	male	Birth	Birth	1752-03-19
4	I1669	Chidsey, Roswell	male	Birth	Birth	1754-07-17
5	I1670	Chidsey, Street	male	Birth	Birth	1756-11-15
6	I1671	Chidsey, Sarah	female	Birth	Birth	1758-10-20
7	I1672	Chidsey, Simon	male	Birth	Birth	1762-03-03
8	I1673	Chidsey, Rhoda	female	Birth	Birth	1764-07-21
9	I1674	Chidsey, Mary	female	Birth	Birth	1765-09-26
10	I1675	Chidsey, Eunice	female	Birth	Birth	1768-05-01
11	I1676	Chidsey, Samuel	male	Birth	Birth	1770-10-08
12	I1677	Chidsey, Ezekiel	male	Birth	Birth	1770-10-08

Hannah Chidsey b. 1747 d. ?

I have been unable to trace much information for this individual. There is a reference to Dodd's East Haven (register?) to indicate a death in 1840! More work is needed here to get a clear picture, if possible.

Sarah Chidsey b. 1758 d. ?

Sarah appears to have been married to Richard Barrett in East haven, CT, on 1/13/1780. However, it is not clear whether they had children. In fact it is not at all clear that this is a correct association. More investigation is required.

Rhoda Chidsey b. 1764 d. 1820?

Rhoda may have married William Seymour and ended up in Delaware Co., NY. If so, she had daughters. However, all that is available online that I can find appears to be hearsay. More work is needed here.

Tracing Ellen's mtDNA

Mary Chidsey Curtis b. 1765 d. ?

Mary married Phineas Curtis and they had a fairly large number of children, including five females.

Father/partner1

Name: Curtis, Phineas [I1678]
 Birth: 1765
 Death: 1806

Mother/partner2

Name: Chidsey, Mary [I1674]
 Birth: 1765-09-26
 Death:

Relationship Information

ID: Type:

Tags:

Children
Events
Source Citations
Attributes
 Notes
Gallery
LDS

#	ID	Name	Gender	Paternal	Maternal	Birth Date
1	I1679	Curtis, Polly	female	Birth	Birth	1788
2	I1680	Curtis, Hannah	female	Birth	Birth	1790
3	I1681	Curtis, Russell	male	Birth	Birth	1792
4	I1682	Curtis, Lowly	female	Birth	Birth	1794
5	I1683	Curtis, Asenath	female	Birth	Birth	1796
6	I1684	Curtis, Benjamin	male	Birth	Birth	1798
7	I1685	Curtis, Major	male	Birth	Birth	1800
8	I1686	Curtis, John	male	Birth	Birth	1802
9	I1687	Curtis, Susan	female	Birth	Birth	1804
...	I1688	Curtis, Street	male	Birth	Birth	1806

Eunice Chidsey Walker b. 1768 d. ?

I appears that Eunice married William Walker (b. 1766) and they had only three male offspring.

Father/partner1

Name: Walker, William [I1689]
 Birth: 1766-02-06
 Death:

Mother/partner2

Name: Chidsey, Eunice [I1675]
 Birth: 1768-05-01
 Death:

Relationship Information

ID: Type:

Tags:

Children
 Events
Source Citations
Attributes
Notes
Gallery
LDS

#	ID	Name	Gender	Paternal	Maternal	Birth Date
1	I1691	Walker, John	male	Birth	Birth	1788
2	I1692	Walker, William	male	Birth	Birth	1790
3	I1690	Walker, James	male	Birth	Birth	1792

Tracing Ellen's mtDNA

Mary Shepard b. 1731 d. 1743

Since this Mary Shepard died at about the age of 12, it is reasonable to assume that she had no children.

Elizabeth Shepard Hotchkiss b. 1734 d. 1819

Elizabeth married Enos Hotchkiss, and her findagrave memorial indicates that she and Enos had four children before they died in Vermont.

Father/partner1 -

Name: Hotchkiss, Enos [I1693]
Birth: 1731-05-13
Death: 1806-10-27

Mother/partner2 -

Name: Shepard, Elizabeth [I1657]
Birth: 1734-07-20
Death: 1819-02-21

Relationship Information

ID: Type: Married

Tags:

Children Events Source Citations Attributes Notes Gallery LDS

#	ID	Name	Gender	Paternal	Maternal	Birth Date
1	I1694	Hotchkiss, Huldah	female	Birth	Birth	
2	I1695	Hotchkiss, Elihu	male	Birth	Birth	1756
3	I1696	Hotchkiss, Enoch	male	Birth	Birth	1763
4	I1697	Hotchkiss, Stephen	male	Birth	Birth	1772

Mary Shepard b. 1746 d.?

I am afraid that there is confusion in the ranks over two families - one headed by Mary Shepard and David Grannis, offspring of Russell and Lydia (Forbes) Grannis and Thomas and Sarah (Hotchkiss) Shepard. The children of this marriage are often listed with the same names as the one from the other marriage - that being between Sarah Russell (daughter of John and Sarah (Russell) Shepard) and the same David Grannis.

The issue of the two Mary's needs to be resolved before anything can be confidently concluded about marriages and offspring.

References:

The Church of Jesus Christ of Latter-day Saints, "International Genealogical Index (IGI)," database, FamilySearch (<https://familysearch.org/ark:/61903/2:1:M6YR-8N1> : accessed 9 February 2019), entry for Mary Shepard, batch A22760-7; citing FHL microfilm 455,111; submitter not specified.

Tracing Ellen's mtDNA

"Pedigree Resource File," database, FamilySearch (<https://familysearch.org/ark:/61903/2:2:SB1J-9LL> : accessed 9 February 2019), entry for Mary /Shepard/, cites sources; file (2:2:2:MMW8-HB9), submitted 15 May 2011.

Huldah Shepard Townsend b. 1755

Huldah married Elias Townsend and they had an assortment of children. It may be that they moved west into NY.

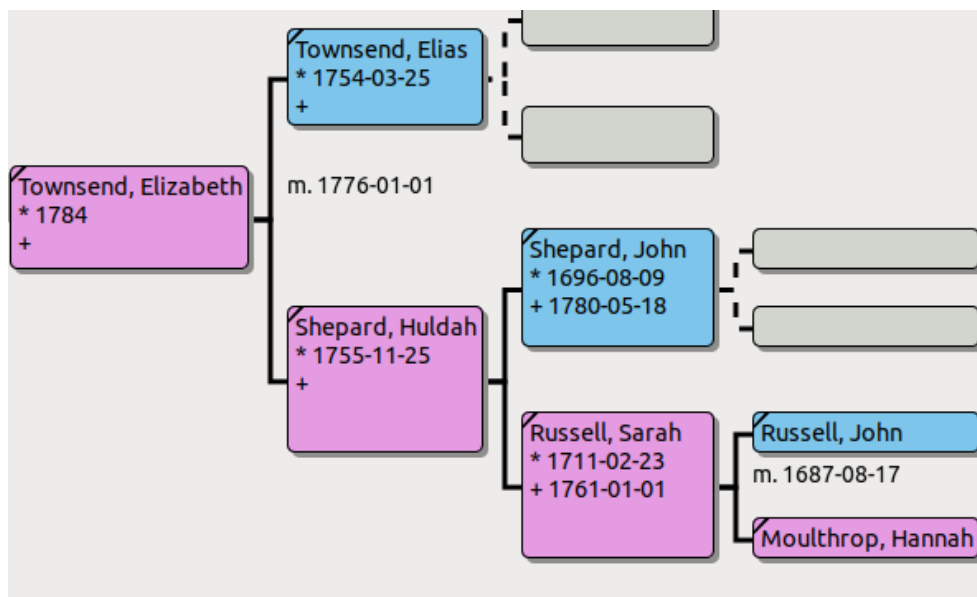

Father/partner1 -

Name: Townsend, Elias [I1740]
 Birth: 1754-03-25
 Death:

Mother/partner2 -

Name: Shepard, Huldah [I1663]
 Birth: 1755-11-25
 Death:

Relationship Information

ID: Type:

Tags:

Children | Events | Source Citations | Attributes | Notes | Gallery | LDS

#	ID	Name	Gender	Paternal	Maternal	Birth Date
1	I1741	Townsend, Huldah	female	Birth	Birth	1782
2	I1742	Townsend, Elias	male	Birth	Birth	1779
3	I1743	Townsend, Elizabeth	female	Birth	Birth	1784
4	I1744	Townsend, Nancy	female	Birth	Birth	1788

Tracing Ellen's mtDNA

Kezia Moulthrop Barker b. 1682 d. 1767

Kezia's children of interest are

Hannah Barker,

Kezia Barker,

Lydia Barker,

Thankful Barker.

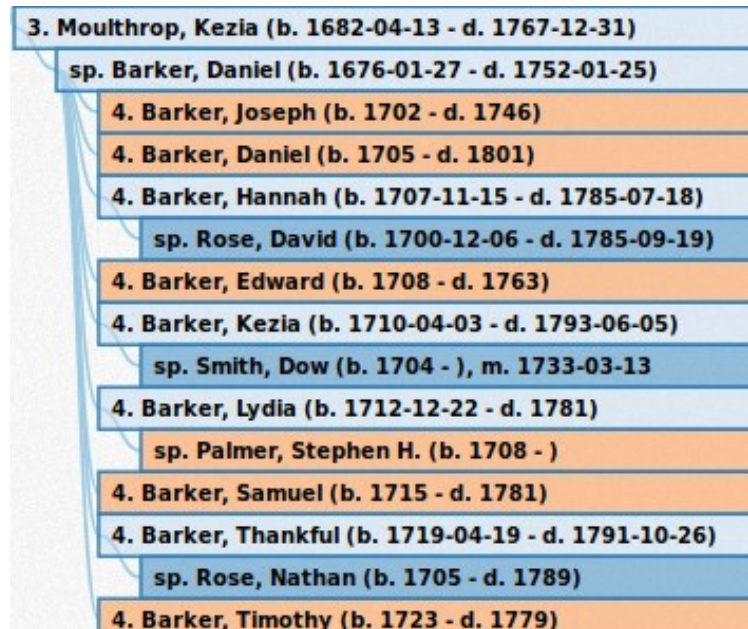

Tracing Ellen's mtDNA

Hannah Barker Rose b. 1707 d. 1785

Hannah and her husband David Rose had just one daughter – Kesiah.

Unfortunately her story appears to be a sad one. - She married David Hudson. Kesiah must have died in childbirth and

Father/partner1

Name: Rose, David [I1615]
Birth: 1700-12-06
Death: 1785-09-19

Mother/partner2

Name: Barker, Hannah [I1565]
Birth: 1707-11-15
Death: 1785-07-18

Relationship Information

ID: Type:

Tags:

Children Events Source Citations Attributes Notes Gallery LDS

#	ID	Name	Gender	Paternal	Maternal	Birth Date
1	I1616	Rose, Keziah	female	Birth	Birth	1730
2	I1617	Rose, David	male	Birth	Birth	1736
3	I1618	Rose, Simeon	male	Birth	Birth	1747
4	I1619	Rose, Levi	male	Birth	Birth	1751

the son, also named David, only survived about 4 months. Kesiah's husband did not wait to remarry. He married Rebecca Fowler the next summer.

Kezia Barker Smith b. 1710 d. 1793

Kesia and her husband only produced male offspring from what I can tell.

Father/partner1

Name: Smith, Dow [I1621]
Birth: 1704
Death:

Mother/partner2

Name: Barker, Kezia [I1567]
Birth: 1710-04-03
Death: 1793-06-05

Relationship Information

ID: Type:

Tags:

Children Events Source Citations Attributes Notes Gallery LDS

#	ID	Name	Gender	Paternal	Maternal	Birth Date
1	I1622	Smith, Isaac	male	Birth	Birth	1743
2	I1623	Smith, Dow	male	Birth	Birth	1745
3	I1624	Smith, Daniel	male	Birth	Birth	1748
4	I1625	Smith, Jordan	male	Birth	Birth	1733

Tracing Ellen's mtDNA

Lydia Barker Palmer b. 1712 d. 1781

Lydia married Stephen H. Palmer and they had a family that included two daughters – Phebe and Esther.

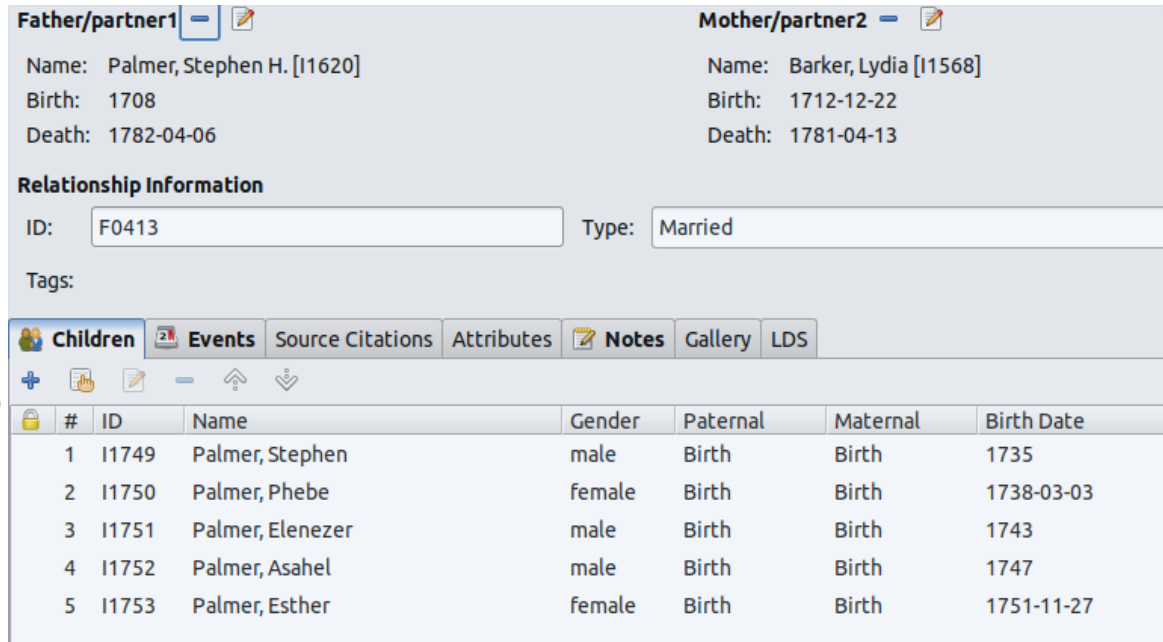

Father/partner1 

Name: Palmer, Stephen H. [I1620]
Birth: 1708
Death: 1782-04-06





















Mother/partner2 

Name: Barker, Lydia [I1568]
Birth: 1712-12-22
Death: 1781-04-13

Relationship Information

ID: F0413 Type: Married

Tags:

Children                    

#	ID	Name	Gender	Paternal	Maternal	Birth Date
1	I1749	Palmer, Stephen	male	Birth	Birth	1735
2	I1750	Palmer, Phebe	female	Birth	Birth	1738-03-03
3	I1751	Palmer, Ebenezer	male	Birth	Birth	1743
4	I1752	Palmer, Asahel	male	Birth	Birth	1747
5	I1753	Palmer, Esther	female	Birth	Birth	1751-11-27

Daughter Phebe married Ebenezer Foote in Branford, CT. They had daughters Thankful (b. 1759), who married Isaac Smith (b. 1755 – a cousin?), and Lucretia (b. 1765), who married James Butler (b. 1761). The while family seems to have been in the Branford area in the late 18th century.

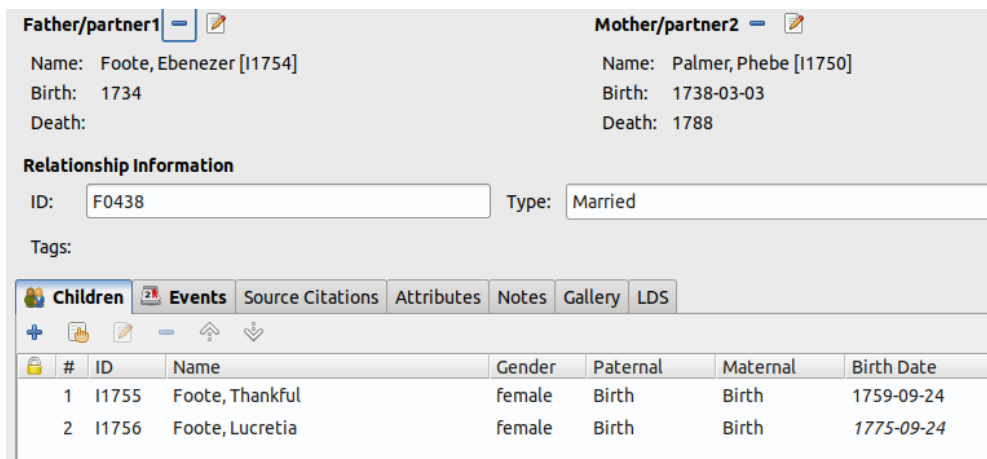

Father/partner1 

Name: Foote, Ebenezer [I1754]
Birth: 1734
Death:





















Mother/partner2 

Name: Palmer, Phebe [I1750]
Birth: 1738-03-03
Death: 1788

Relationship Information

ID: F0438 Type: Married

Tags:

Children                    

#	ID	Name	Gender	Paternal	Maternal	Birth Date
1	I1755	Foote, Thankful	female	Birth	Birth	1759-09-24
2	I1756	Foote, Lucretia	female	Birth	Birth	1775-09-24

I have been unable to find anything other than a birth record for the daughter named Esther.

Tracing Ellen's mtDNA

Thankful Barker Rose b. 1719 d. 1791

Thankful and her husband, Nathan, had a family that included one girl, named Sarah.

Father/partner1		Mother/partner2					
Name: Rose, Nathan [I1626]		Name: Barker, Thankful [I1570]					
Birth: 1705		Birth: 1719-04-19					
Death: 1789		Death: 1791-10-26					
Relationship Information							
ID: <input type="text" value="F0415"/>		Type: <input type="text" value="Married"/>					
Tags:							
<div style="display: flex; justify-content: space-between; font-size: small;"> Children Events Source Citations Attributes Notes Gallery LDS </div>							
<div style="display: flex; justify-content: space-around; font-size: x-small;"> </div>							
	#	ID	Name	Gender	Paternal	Maternal	Birth Date
	1	I1627	Rose, Sarah	female	Birth	Birth	1748-04-24
	2	I1759	Rose, Joseph	male	Birth	Birth	
	3	I1760	Rose, Nathan	male	Birth	Birth	

Sarah married Solomon Whedon. They appear to have ended their days in Litchfield Co., CT. I have not traced their daughter, Lucretia.

Father/partner1		Mother/partner2					
Name: Whedon, Solomon [I1628]		Name: Rose, Sarah [I1627]					
Birth: 1749		Birth: 1748-04-24					
Death: 1814-12-12		Death: 1821-01-10					
Relationship Information							
ID: <input type="text" value="F0416"/>		Type: <input type="text" value="Married"/>					
Tags:							
<div style="display: flex; justify-content: space-between; font-size: small;"> Children Events Source Citations Attributes Notes Gallery LDS </div>							
<div style="display: flex; justify-content: space-around; font-size: x-small;"> </div>							
	#	ID	Name	Gender	Paternal	Maternal	Birth Date
	1	I1629	Whedon, Lucretia	female	Birth	Birth	1782

Tracing Ellen's mtDNA

Abigail Thompson Alsop Miles b. 1651 d. 1727

Her findagrave memorial (https://www.findagrave.com/memorial/64415523/abigail-alsop_miles#source) reads as follows.

“

Abigail (twin) was the 4-5th child and 3rd -4th daughter of John & Ellen (____) Thompson of East Haven. She was b. 26 Jan 1651; m. (1) 25 Nov 1672 Joseph Alsop, Jr. (b. abt 1694 & d. 12 Jan 1691). She m. (2) Capt. John Miles, Jr. (b. 9 Jan 1668 & d. 10 Feb 1710). She d. 1727.

”

I can find no evidence that either of her marriages produced children.

Abigail's first husband was Joseph Alsop, whose findagrave memorial (https://www.findagrave.com/memorial/8639056/joseph-alsop_allsup) reads as follows.

“

~MY ALSOP & THOMPSON FAMILIES~

Joseph was the son of Joseph & Elizabeth (Preston) Alsop and grandson of my ancestors, JOHN & TEMPERENCE (GILBERT) ALSOP of Derbyshire, England.

His father, Joseph, Sr. came from London to America in 1635 in the "Elizabeth & Ann." He was a mariner.

Joseph, Jr. married Abigail Thompson, daughter of my ancestors, JOHN & ELLEN (HARRISON) THOMPSON on 25 Nov 1672 in New Haven, CT.

”

Abigail's second husband was John Miles, whose findagrave memorial (<https://www.findagrave.com/memorial/28364373/john-miles>) reads as follows.

“

MY MILES FAMILY~

The son of my ancestors, [CAPT. JOHN MILES](#) and [ELIZABETH \(HARRIMAN\) MILES](#), he married Hannah Prindle in 1687 in New Haven Colony.

Their son: [Major Thomas Miles](#)

Donald Lines Jacobus's article "Captain John Miles the Weaver, Ancestor of the Wallingford and Goshen, Conn., Families," in *The American Genealogist* (vol. 35 [October 1959], p. 247-55), established that Capt. John Miles who was buried at Grove Street Cemetery in New Haven

Tracing Ellen's mtDNA

was all but certainly *not* the same man as Capt. John³ Miles, son of John², grandson of Richard¹ Miles, the 1639 emigrant to New Haven from Great Munden, Hertfordshire. Capt. John³ Miles moved to Elizabethtown, New Jersey and died there in 1708.

Capt. John Miles who died 10 Feb 1709/10 and was buried at Grove Street Cemetery was variously called "weaver" and "clothier" in New Haven records. By a first wife whose identity is unknown, he had four sons:

- 1) Maj. Thomas Miles (c1682–1741), m. Abigail Mix
- 2) John Miles (c1684–1760), m. Sarah Ball
- 3) Joseph Miles, presumably the man who m. Jane Bowden 19 Nov 1718 in Newtown, Conn.
- 4) a fourth son whose name is unknown.

By 1694, John Miles the weaver married as his second wife Abigail (Thompson) Alsop, widow of Joseph Alsop, who had died 12 Jan 1690/1.

Contributor:

Derek Wood - derekwood@gmx.com

”

Tracing Ellen's mtDNA

Rebecca Thompson Thomas b. 1651 d. 1716

Married Daniel
Thomas b. 1647.

They had daughters
named . . .
Dorothy,
Dinah,
Recompence,
Experience.

You have to love
the names of this
period!

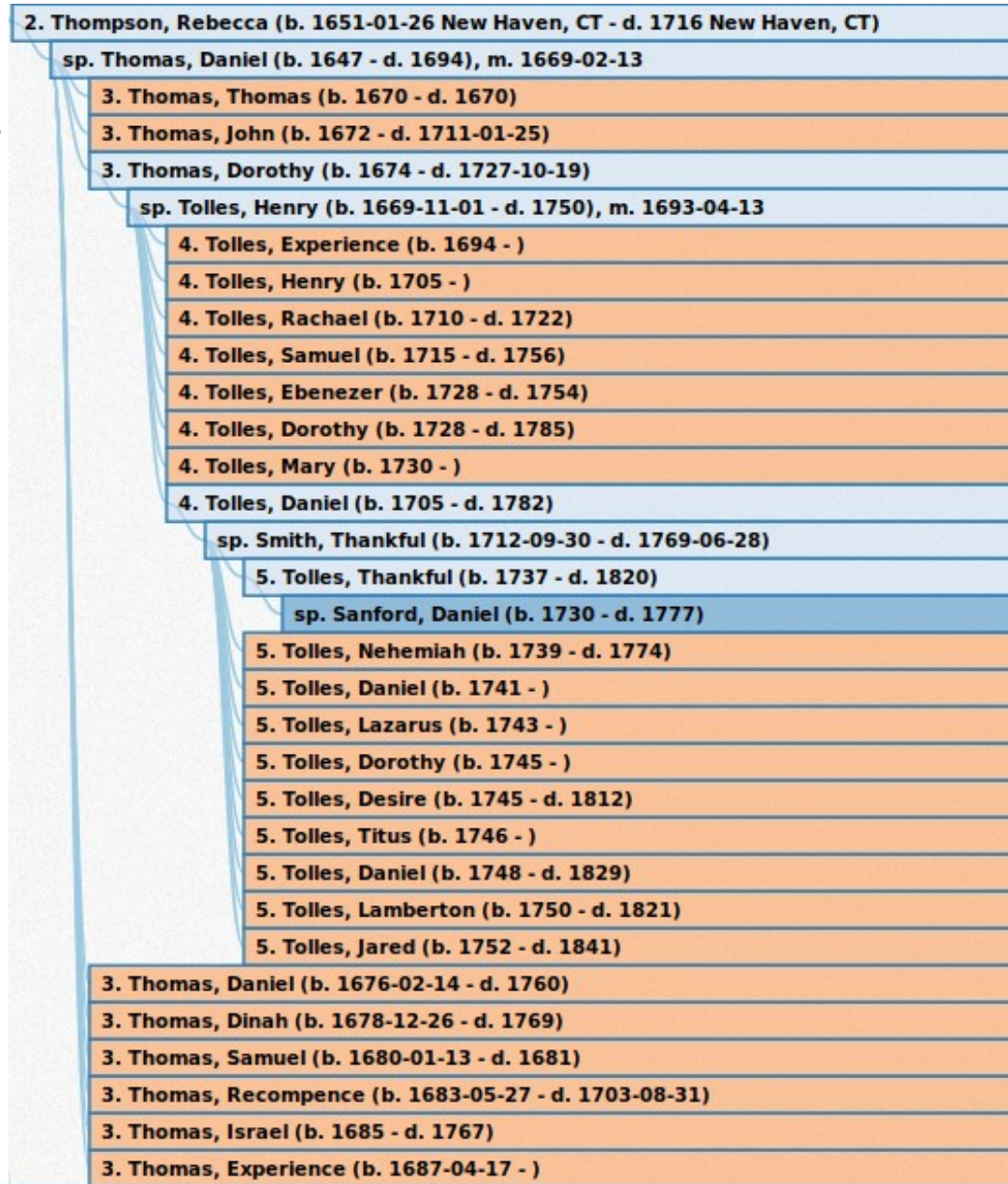

Tracing Ellen's mtDNA

Dorothy Thomas Tolles b. 1674 d. 1727

Following Dorothy's line brings us first to Experience Tolles, then Rachel, Dorothy, and Mary

Father/partner1

Name: Tolles, Henry [I1579]
 Birth: 1669-11-01
 Death: 1750

Mother/partner2

Name: Thomas, Dorothy [I1550]
 Birth: 1674
 Death: 1727-10-19

Relationship Information

ID: F0405 Type: Married

Tags:

Children
Events
Source Citations
Attributes
Notes
Gallery
LDS

#	ID	Name	Gender	Paternal	Maternal	Birth Date
1	I1580	Tolles, Experience	female	Birth	Birth	1694
2	I1581	Tolles, Henry	male	Birth	Birth	1705
3	I1582	Tolles, Rachael	female	Birth	Birth	1710
4	I1583	Tolles, Samuel	male	Birth	Birth	1715
5	I1584	Tolles, Ebenezer	male	Birth	Birth	1728
6	I1585	Tolles, Dorothy	female	Birth	Birth	1728
7	I1586	Tolles, Mary	female	Birth	Birth	1730
8	I1587	Tolles, Daniel	male	Birth	Birth	1705

Experience Tolles Osborne b. 1694 d. 1737

And Experience leads to her first daughter Esther. (below)

Father/partner1

Name: Osborne, Joseph [I1763]
 Birth: 1694-02-18
 Death: 1724

Mother/partner2

Name: Tolles, Experience [I1580]
 Birth: 1694
 Death: 1737

Relationship Information

ID: F0441 Type: Married

Tags:

Children
Events
Source Citations
Attributes
Notes
Gallery
LDS

#	ID	Name	Gender	Paternal	Maternal	Birth Date
1	I1764	Osborne, Daniel	male	Birth	Birth	1715
2	I1765	Osborne, Joseph	male	Birth	Birth	1718
3	I1766	Osborne, Amos	male	Birth	Birth	1722
4	I1767	Osborne, Esther	female	Birth	Birth	1721

Tracing Ellen's mtDNA

Esther Osborne Booth b. 1721 d. ?

Daughter Esther had just a daughter, Elizabeth – born in Fairfield Co., CT. However there is confusion in the compiled records about another daughter named Betsy, who might actually be Elizabeth. If they are the same person, she likely married Hezekiah Sanford (?-1834?) and eventually died in Hartford Co., CT.

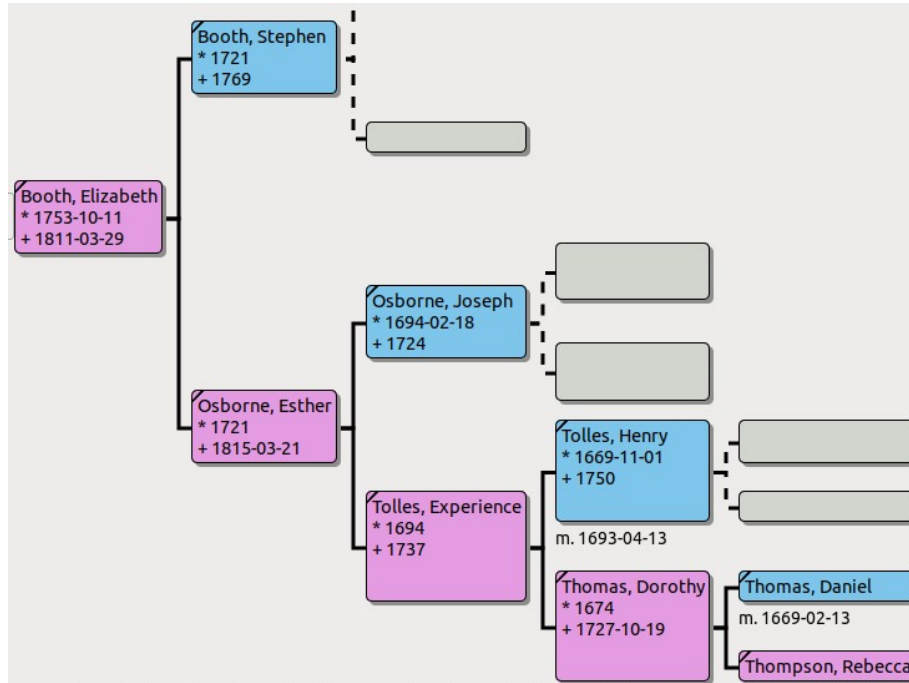

Tracing Ellen's mtDNA

Rachel Tolles Ruggles b. 1710 d. 1746

Rachel's daughters appear to have been Lois, Rachel, Mercy, and Mabel.

Lois Ruggles Warner b. 1721 d. 1781

I have followed Lois b. 1721 and believe that all of her daughters married. The following findagrave memorial provides some hints about these daughters.

Lois Ruggles Warner

Birth: 2 Apr 1727 New Haven, New Haven County, Connecticut, USA

Death: 14 Oct 1781 (aged 54) New Milford, Litchfield County, Connecticut, USA

Burial: Gallow Hills Cemetery, New Milford, Litchfield County, Connecticut, USA

Plot:

Memorial #: 17536832

Bio: Father Joseph Ruggles 1701-1791 Mother Rachel Tolles 170513 RUGGLES siblings: Samuel, Elizabeth, Mary, Sarah, Rachel, Mercy, Mable, Timothy, Benjamin, Joseph, Ashbel, Lucy, Anna.

Lois married Oliver Warner on 10/16/1751.

Children:

1. Lucy Warner (9/17/1752-8/22/1799); m. 1) Ichabod Bostwick on 2/27/1771, m. 2) Nathaniel Dickee....3 BOSTWICK children: ...1.Lois Ann Bostwick 1772...2.Sally Bostwick 1772...3.Oliver Bostwick 1776

2. Tryphene Warner (12/14/1753-6/16/1815); m. Benjamin Starr Mygatt (1746-2/6/1794) on 4/5/1775. BENJAMIN: #11571978

3.Mabel Warner(9/20/1757-5/3/1801); m.Daniel Nobel Carrington on 6/19/1802....2 CARRINGTON children:...1. Mary Carrington ...2. Lucy Carrington Memorial: #40451251

4. Reuben Warner (5/23/1759-11/14/1825); m. Eunice Carrington....1 WARNER child known: William R. Warner Memorial: #25892381

5. Prudence Warner B-8/28/1761; m. () Couch.

6. Tamar Warner B-7/20/1764; m. () Beach_____Andrew-1 Warner lineage.

Inscription: In memory of Lois, wife of Oliver Warner, who Died Oct 14th 1781 in the 55th year of her age

Family Members

Tracing Ellen's mtDNA

Parents

Joseph Ruggles 1701-1791

Spouse

Oliver Warner 1729-1814

Siblings

Joseph Ruggles 1728-1802

Lazarus Ruggles 1730-1797

Rachel Ruggles Bishop 1732-1800

Mercy Ruggles Bostwick 1732-1822

Mabel Ruggles Bostwick 1736-1804

Ashbel Ruggles 1739-1814

Children

Reuben Warner 1759-1825

Maintained by: Find A Grave (8)

Originally Created by: eobfindagrave (46779688)

Added: 17 Jan 2007

URL: <https://www.findagrave.com/memorial/17536832/lois-warner>

Citation: Find A Grave, database and images (<https://www.findagrave.com> : accessed 12 February 2019), memorial page for Lois Ruggles Warner (2 Apr 1727–14 Oct 1781), Find A Grave Memorial no. 17536832, citing Gallow Hills Cemetery, New Milford, Litchfield County, Connecticut, USA ; Maintained by Find A Grave (contributor 8) .

Rachel Ruggles Bishop b. 1732 d. 1800

Following Rachel has led to the following findagrave entry that indicates that she died in Vermont, after having a number of daughters (all who married).

Rachel Ruggles Bishop

Birth: 7 Jul 1732 New Haven, New Haven County, Connecticut, USA

Death: 1800 (aged 67–68) Monkton Ridge, Addison County, Vermont, USA

Burial: Unknown

Memorial #: 128309195

Bio: "Royal Families: Americans of royal and noble ancestry" 2nd Edition, p.259, shows Rachel(Ruggles) Bishop died after the census of 1800 in Monkton, Addison County, Vermont. The two likely cemeteries are Monkton Boro Cemetery and Monkton Ridge Cemetery.

Tracing Ellen's mtDNA

Monkton Ridge seems more likely as it bordered on the farm land owned by John and Rachel (Ruggles) Bishop.

Family Members

Parents

Joseph Ruggles	1701-1791
Rachel Tolles Ruggles	1702-1746

Spouse

John Bishop	1730-1801
-------------	-----------

Siblings

Joseph Ruggles	1728-1802
Mercy Ruggles Bostwick	1732-1822
Mabel Ruggles Bostwick	1736-1804
Ashbel Ruggles	1739-1814

Half Siblings

Lois Ruggles Warner	1727-1781
Lazarus Ruggles	1730-1797

Children

Rachel Bishop Curtis	1752-1841
John Bishop	1757-1801
Ruby Bishop Spalding	1759-1826
Elijah Bishop	1763-1839
Urania (Urane) Bishop Kellogg	1768-Unknown
Naphthali Bishop	1770-1849
Samuel Bishop	1772-1842

Created by: Chuck Templin (47502461)

Added: 21 Apr 2014

URL: <https://www.findagrave.com/memorial/128309195/rachel-bishop>

Citation: Find A Grave, database and images (<https://www.findagrave.com> : accessed 12 February 2019), memorial page for Rachel Ruggles Bishop (7 Jul 1732–1800), Find A Grave Memorial no. 128309195, ; Maintained by Chuck Templin (contributor 47502461) Unknown.

Mercy Ruggles Bostwick b. 1732 d. 1822

Another findagrave entry (for Mercy) indicates that she married Edwin Bostwick. They had no daughters according to this reference.

<https://www.findagrave.com/memorial/103254453/mercy-bostwick>

Tracing Ellen's mtDNA

Mabel Ruggles Bostwick b. 1736 d. 1804



<https://www.findagrave.com/memorial/120371848/mabel-bostwick> is a reference that indicates that Mabel had three daughters. Only one survived to marry. This survivor was named Lois and she married a man named Bildad Hine. (I did not make that up!) They are buried in Trumbull Co., OH.

Tracing Ellen's mtDNA



Dorothy Tolles Bristol b. 1711 d. 1785

This marriage produced three daughters for us to follow.

(By the way, the Bristol line figures into my maternal line another way – see Huldah Nichols' ancestors.)

Father/partner1  

Name: Bristol, Stephen [I1780]
Birth: 1707
Death: 1785







Mother/partner2  

Name: Tolles, Dorothy [I1585]
Birth: 1711
Death: 1785-08-14

Relationship Information

ID: Type:

Tags:

Children      

#	ID	Name	Gender	Paternal	Maternal	Birth Date
1	I1781	Bristol, Stephen	male	Birth	Birth	1734
2	I1782	Bristol, Ichabod	male	Birth	Birth	1736
3	I1783	Bristol, Abner	male	Birth	Birth	1738
4	I1784	Bristol, Rachel	female	Birth	Birth	1739-12-11
5	I1785	Bristol, David	male	Birth	Birth	1742
6	I1786	Bristol, Dorothy	female	Birth	Birth	1748
7	I1787	Bristol, Dinah	female	Birth	Birth	1751

Rachel Bristol Smith Downs b. 1739 d. 1817

Rachel seems to have been married twice. The second marriage to Samuel Downs produced two sons and no daughters. The first marriage to David Smith produced two daughters – Mabel (b. 1760 d. 1852) and Esther (b. 1762 d. 1846).

Mabel appears to have married Noah Alling (1757-1848). We have seen the Alling family before!

The Alling family looks to have been popular with Esther as well. She married Roger Alling (1762-1840).

Dorothy Bristol Thomas b. 1748 d. 1834

Dorothy Married one Samuel Thomas (b. 1750). Their children included two daughters: Susanah (1790-1795) and Statira (1794-?) - according to a family tree on ancestry.com at least.

Dinah Bristol Candee b. 1751 d. 1785

Dinah and her husband David (1747-1841) may have had a fairly large family that included daughters Dinah, Lucena, Lucinda, Polly, and Esther. I have not tracked any of these daughters.

Tracing Ellen's mtDNA

Mary Tolles b. 1730 d. 1731?

I can find no evidence that Mary ever married. One unsourced tree indicates that she died in 1731, which would account for the null result. It may be that she is being confused with another Mary Tolles born in 1729 of different parents (Henry Tolles and Mary Goodsell). I'm going to speculate that this is a mtDNA dead end.

Tracing Ellen's mtDNA

Dinah Thomas Sherman b. 1678 d. 1769

Dinah most likely had three daughters – Lydia, Dinah, and Elizabeth.

Father/partner1		Mother/partner2				
Name:	Sherman, John [I1788]	Name:	Thomas, Dinah [I1574]			
Birth:	1673	Birth:	1678-12-26			
Death:	1727	Death:	1769			
Relationship Information						
ID:	<input type="text" value="F0445"/>	Type:	<input type="text" value="Married"/>			
Tags:						
Children Events Source Citations Attributes Notes Gallery LDS						
+ [Icons]						
#	ID	Name	Gender	Paternal	Maternal	Birth Date
1	I1789	Sherman, Lydia	female	Birth	Birth	1699-12-20
2	I1790	Sherman, Dinah	female	Birth	Birth	1702-10-27
3	I1791	Sherman, Samuel	male	Birth	Birth	1704-02-01
4	I1792	Sherman, Elizabeth	female	Birth	Birth	1708-01-25

Some researchers have confused this New haven family with another Sherman family in Fairfield Co. headed by Daniel, not John Sherman.

Tracing Ellen's mtDNA

Lydia Sherman Todd b. 1699 d. 1733

Lydia Sherman's daughters, all born in the New Haven Co., CT, area were Lydia, Lois, and Eunice.

Father/partner1

Name: Todd, James [I1795]
 Birth: 1696
 Death: 1779

Mother/partner2

Name: Sherman, Lydia [I1789]
 Birth: 1699-12-20
 Death: 1733-09-17

Relationship Information

ID: Type:

Tags:

Children **Events** **Source Citations** **Attributes** **Notes** **Gallery** **LDS**

#	ID	Name	Gender	Paternal	Maternal	Birth Date
1	I1796	Todd, Ebenezer	male	Birth	Birth	1722
2	I1797	Todd, James	male	Birth	Birth	1725
3	I1798	Todd, Lydia	female	Birth	Birth	1727-07-06
4	I1799	Todd, Lois	female	Birth	Birth	1729-11-10
5	I1800	Todd, Eunice	female	Birth	Birth	1732-06-10

Lydia Todd Smith b. 1727 d. 1819

Married James Smith and had daughters Mary and Mabel.

Mary married James Pardee (1746-1827) in 1772. They had a number of daughters that may have included: Polly, Sarah, Mabel, Martha, and Isabel. It appears that they stayed in the New Haven Co., CT, area.

Mabel married Merriman Munson

Father/partner1

Name: Smith, James [I1801]
 Birth: 1713
 Death: 1805

Mother/partner2

Name: Todd, Lydia [I1798]
 Birth: 1727-07-06
 Death: 1819-09-14

Relationship Information

ID: Type:

Tags:

Children **Events** **Source Citations** **Attributes** **Notes** **Gallery** **LDS**

#	ID	Name	Gender	Paternal	Maternal	Birth Date
1	I1802	Smith, Mary	female	Birth	Birth	1747
2	I1803	Smith, James	male	Birth	Birth	1750
3	I1804	Smith, Benjamin	male	Birth	Birth	1753
4	I1805	Smith, John	male	Birth	Birth	1756
5	I1806	Smith, Thomas	male	Birth	Birth	1761
6	I1807	Smith, Eli	male	Birth	Birth	1764
7	I1808	Smith, Mabel	female	Birth	Birth	1769

(b. ? d. 1818). According to a findagrave memorial, they had three children – two males and one

Tracing Ellen's mtDNA

female. The one daughter, Mary was born in 1804 and married a John Cook (1799-1858). They lived in New Haven Co., CT, and they had a family that included two daughters.

Lois Todd Turner b. 1729 d. 1812

Lois married James Turner (1727-1788). Their family consisted of three daughters: Lois, Mary, and Dorcas.

Father/partner1 **Mother/partner2**

Name: Turner, James [I1813] Name: Todd, Lois [I1799]
Birth: 1727 Birth: 1729-11-10
Death: 1788 Death: 1812-09-27

Relationship Information

ID: Type:

Tags:

Children

#	ID	Name	Gender	Paternal	Maternal	Birth Date
1	I1814	Turner, Lois	female	Birth	Birth	1748-10-12
2	I1815	Turner, Bethuel	male	Birth	Birth	1751
3	I1816	Turner, Mary	female	Birth	Birth	1754-04-17
4	I1817	Turner, Dorcas	female	Birth	Birth	1756-09-30
5	I1818	Turner, Bethuel	male	Birth	Birth	1761

Records indicate that Lois (1748-1776) married one James Ives (1751-1826) and that they had one daughter, Bede, who survived and married Jared Goodyear.

Mary (1754-1829) married Hezekiah Tuttle (1749-1835) and they had many children, apparently including just one daughter, Lydia (b.1783 d. 1862?), who may have married one Amos Abbey.

Dorcas (1756-1831) married Samuel Thorpe (?-1820). They also had many children in their family in New haven Co., CT. Here is a list of daughters: Chloe (1779-?), Patience (1780-?), Lowly (1786-1858), Rhoda (1789-?), Sally (1794-1795). I have not traced any of these daughters.

Tracing Ellen's mtDNA

Eunice Todd Gilbert b. 1732 d. 1832

Eunice may have married John Gilbert (1731?-1779?), but there is some confusion that may stem from the existence of two John Gilberts and/or two wives (Eunice Todd versus Lydia Ives). I was not able to sort out the conflicting views of history.

What I present here is the version in which Eunice Todd married John Gilbert and built a family in New Haven Co., CT, consisting of six children, four of whom were daughters.

The screenshot shows a genealogy software interface. At the top, there are two columns: "Father/partner1" and "Mother/partner2". Under "Father/partner1", the name is "Gilbert, John [I0000]", birth is "1731", and death is blank. Under "Mother/partner2", the name is "Todd, Eunice [I1800]", birth is "1732-06-10", and death is "1823". Below this is a "Relationship Information" section with "ID: F0450" and "Type: Unknown". There are tabs for "Children", "Events", "Source Citations", "Attributes", "Notes", "Gallery", and "LDS". The "Children" tab is active, showing a table of six children.

#	ID	Name	Gender	Paternal	Maternal	Birth Date
1	I1794	Gilbert, Sarah	female	Birth	Birth	1758-08-26
2	I1819	Gilbert, Eunice	female	Birth	Birth	1762-02-20
3	I1821	Gilbert, John	male	Birth	Birth	1764
4	I1822	Gilbert, Mabel	female	Birth	Birth	1767-05-10
5	I1820	Gilbert, Lydia	female	Birth	Birth	1769-01-29
6	I1823	Gilbert, Julius	male	Birth	Birth	1771

Sarah Gilbert (1758-?) - It seems clear that Sarah was a daughter of Eunice and John. However, I can find no clear evidence of her marriage or death. She would be easily confused with Sarah Gilbert (b. 9/9/1758) to Hezekiah Gilbert and his with Tameson Gregory in Fairfield Co., CT. More research could be done on this.

Eunice Gilbert (1762-1835) married Jesse Tuttle (1759-1848). I did not look for any offspring that they may have produced.

Consensus opinion is that Mabel Gilbert (1767) married Ezra Munson (1757-1800). Their family located in new haven, CT, consisted of Lydia, Harriet, Austin, Chauncy, Justus, and Kezia.



Lydia Gilbert (1769-1774) died quite early in life.

Tracing Ellen's mtDNA

Dinah Sherman Atwater b. 1702 d. 1739

The marriage of Dinah Sherman and James Atwater looks like the right one to follow in this case.

The Atwater/Sherman family likely had six children – James, Abigail (1727-?), Elijah (2x?), Lydia (1734-?), and Rachel (1737-?). Note that after Dinah's death in 1739, James must have married Elizabeth Alling. Following the daughters of the first marriage yields one more generation . . .

Father/partner1  **Mother/partner2** 







Name: Atwater, James [I1826] Name: Sherman, Dinah [I1790]
Birth: 1698 Birth: 1702-10-27
Death: 1766 Death: 1739-12-19

Relationship Information

ID: Type:

Tags:

Children  **Events** **Source Citations** **Attributes** **Notes** **Gallery** **LDS**

#	ID	Name	Gender	Paternal	Maternal	Birth Date
1	I1827	Atwater, James	male	Birth	Birth	1724
2	I1828	Atwater, Abigail	female	Birth	Birth	1727-11-19
3	I1829	Atwater, Elijah	male	Birth	Birth	1730
4	I1830	Atwater, Elijah	male	Birth	Birth	1732
5	I1831	Atwater, Lydia	female	Birth	Birth	1734-08-25
6	I1832	Atwater, Rachel	female	Birth	Birth	1737-04-26

Tracing Ellen's mtDNA

Abigail Atwater Peck b. 1727 d. ?

Abigail married Nicholas Peck (1732-1793) in New haven in 1753 and they had the following female children.

Father/partner1		Mother/partner2	
Name: Peck, Nicholas [11833]	Birth: 1732	Name: Atwater, Abigail [11828]	Birth: 1727-11-19
Death: 1793		Death:	

Relationship Information

ID: Type:

Tags:

Children | **Events** | Source Citations | Attributes | Notes | Gallery | LDS

#	ID	Name	Gender	Paternal	Maternal	Birth Date
1	I1834	Peck, Abigail	female	Birth	Birth	1754-12-13
2	I1835	Peck, Mary	female	Birth	Birth	1758-08-27
3	I1836	Peck, Pamela	female	Birth	Birth	1761-01-25
4	I1837	Peck, william	male	Birth	Birth	1763
5	I1838	Peck, Elijah	male	Birth	Birth	1765
6	I1839	Peck, Mary	female	Birth	Birth	1767-10-31
7	I1840	Peck, Sarah	female	Birth	Birth	1770-03-10

Abigail Peck Cook b. 1754 d. 1787

Abigail was married to Joseph Cook, but she died quite early in life in Dutchess Co., NY. "She was his first wife. Children were: Hannah, William, Elizabeth, Simeon, Lucy, Zena and Lyman David. She is buried next to Lucy and child of Joseph and second wife, Olive." - From findagrave memorial <https://www.findagrave.com/memorial/23416867/cook#clipboard> .

Mary Peck b. 1758 d. ?

I can find no clear records for Mary other than the record of her birth. More research is needed.

Pamela Peck b. 1761 d. ?

I can find no clear records for Pamela. Just one pedigree submission mentions her. - "Pedigree Resource File," database, *FamilySearch* (<https://familysearch.org/ark:/61903/2:2:SBQK-7FM> : accessed 15 February 2019), entry for Pamela /Peck/; file (2:2:2:MM7Y-Z63), submitted 14 May 2011 by shalom [identity withheld for privacy].

Mary Dinah Peck b. 1767

I can find no clear records for this Mary other than the record of her birth, which shows her name as Mary Dinah. More research is needed.

Tracing Ellen's mtDNA

Sarah b. 1770 d. 1770

Lydia Atwater b. 1734 d. 1748?

There are at least 3 death records for a person named Lydia Atwater. Assuming that one is accurate, it is reasonable to assume Lydia died before she could have been responsible for any daughters.

Rachel Atwater Bradley b. 1737 d. 1809

A findagrave memorial indicates that Rachel married Jonah Bradley (1732-1814). They had two daughters – Betsy M. Bradley Sanger and Sarah Bradley Viall. These were New haven families, except for that of Sarah, who ended up in Onondaga Co., NY.

Tracing Ellen's mtDNA

Elizabeth Sherman Gilbert b. 1708 d. 1738

Elizabeth married Stephen Gilbert on 6/26/1729. They lived in New haven, CT.

They had just one daughter, who married David Potter in 1748.

Father/partner1 -

Name: Gilbert, Stephen [I1844]
Birth: 1708
Death: 1754

Mother/partner2 -

Name: Sherman, Elizabeth [I1792]
Birth: 1708-01-25
Death: 1738-09-17

Relationship Information

ID: Type: Married

Tags:

Children Events Source Citations Attributes Notes Gallery LDS

#	ID	Name	Gender	Paternal	Maternal	Birth Date
1	I1845	Gilbert, Stephen	male	Birth	Birth	1732
2	I1846	Gilbert, Moses	male	Birth	Birth	1735
3	I1847	Gilbert, Sarah	female	Birth	Birth	1730-04-10
4	I1848	Gilbert, Abel	male	Birth	Birth	1737

Sarah Gilbert Potter b. 1730 d. 1798

Sarah Gilbert married David Potter and they had two daughters – Elizabeth and Sarah.

Father/partner1 -

Name: Potter, David [I1849]
Birth: 1717-11-26
Death: 1773-11-26

Mother/partner2 -

Name: Gilbert, Sarah [I1847]
Birth: 1730-04-10
Death: 1798

Relationship Information

ID: F0457 Type: Married

Tags:

Children Events Source Citations Attributes Notes Gallery LDS

#	ID	Name	Gender	Paternal	Maternal	Birth Date
1	I1850	Potter, Abel	male	Birth	Birth	1749
2	I1851	Potter, David	male	Birth	Birth	1751
3	I1852	Potter, Samuel	male	Birth	Birth	1759
4	I1853	Potter, Elizabeth	female	Birth	Birth	1754
5	I1854	Potter, Sarah	female	Birth	Birth	1756

Tracing Ellen's mtDNA

Elizabeth Potter Ford b. 1754 d. 1817

Elizabeth Potter married Stephen Ford. They had three daughters and three sons as shown in the picture.

Anna married Nehemiah Bradley, who later married Anna's sister, Rachel.

I'm not sure what became of Elizabeth Ford.

Father/partner1 -

Name: Ford, Stephen [I1855]
Birth: 1749
Death: 1843

Mother/partner2 -

Name: Potter, Elizabeth [I1853]
Birth: 1754
Death: 1817-01-06

Relationship Information

ID: Type:

Tags:

Children Events Source Citations Attributes Notes Gallery LDS

#	ID	Name	Gender	Paternal	Maternal	Birth Date
1	I1856	Ford, Anna	female	Birth	Birth	1778
2	I1857	Ford, Stephen	male	Birth	Birth	1776
3	I1858	Ford, Nathaniel	male	Birth	Birth	1781
4	I1859	Ford, Elizabeth	female	Birth	Birth	1783
5	I1860	Ford, Rachel	female	Birth	Birth	1786
6	I1861	Ford, Lyman	male	Birth	Birth	1789

Sarah Potter b. 1756 d. 1790?

Sarah may have never married. There are indications that she died in 1790 in New Haven, Co., CT. I have seen no indication that she was ever married.

Tracing Ellen's mtDNA

Recompence Thomas b. 1683 d. 1703

It looks to me as if Recompence died at the age of about 20, without having any children. She lived in new Haven, CT.

Experience Thomas b. 1687 d. 1703

Experience was about six years younger than her sister, Recompence, but it appears that they both died in the same year (1703), on the same day, if the records are accurate. Experience also lived in new haven and likely did not marry or have children.



Tracing Ellen's mtDNA

Mary Thompson Cooper b. 1652 d. ? *

Mary married John Cooper, Jr, and they had a fairly large family in New Haven.

This is the line that leads to my family.

The first three children in this family did not survive long. Surviving daughters: in this generation of this line are . . . Sarah, Mary, Abigail, Hannah, and Rebecca.



Father/partner1  **Mother/partner2** 

Name: Cooper, John Junior [I0098] Name: Thompson, Mary [I0099]
Birth: 1642-05-28 Birth: 1642-04-24
Death: 1703 Death: 1714-11-17

Relationship Information

ID: Type:

Tags:

Children  **Events**  **Source Citations** **Attributes**  **Notes** **Gallery** **LDS**

#	ID	Name	Gender	Paternal	Maternal	Birth Date
1	I1230	Cooper, Rebecca	female	Birth	Birth	1666
2	I1500	Cooper, unknown	female	Birth	Birth	1668
3	I0097	Cooper, Mary	female	Birth	Birth	1669-11-15
4	I1038	Cooper, John	male	Birth	Birth	1670-02-23
5	I1039	Cooper, Sarah	female	Birth	Birth	1673-04-26
6	I1040	Cooper, Samuel	male	Birth	Birth	1675-06-20
7	I1501	Cooper, Mary	female	Birth	Birth	1677-09-04
8	I0120	Cooper, Abigail	female	Birth	Birth	1679-10-03
9	I1502	Cooper, Hannah	female	Birth	Birth	1681-08-10
10	I1041	Cooper, Joseph	male	Birth	Birth	1683-09-11
11	I0122	Cooper, Rebecca	female	Birth	Birth	1689-08-24

Tracing Ellen's mtDNA

Sarah Cooper Munson b. 1673 d. 1736

John Munson and Sarah married in New Haven in 1692 and had daughters Hannah, Amy, Ruth, Mehitabel, Sarah, and Elizabeth.

Father/partner1		Mother/partner2	
Name:	Munson, John [I1505]	Name:	Cooper, Sarah [I1039]
Birth:	1673	Birth:	1673-04-26
Death:	1749	Death:	1736

Relationship Information

ID: Type:

Tags:

Children | **Events** | **Source Citations** | **Attributes** | **Notes** | **Gallery** | **LDS**

#	ID	Name	Gender	Paternal	Maternal	Birth Date
1	I1862	Munson, John	male	Birth	Birth	1693-07-07
2	I1864	Munson, Hannah	female	Birth	Birth	1697-02-09
3	I1506	Munson, Joel	male	Birth	Birth	1702-08-18
4	I1507	Munson, Amy	female	Birth	Birth	1704-09-18
5	I1508	Munson, Ruth	female	Birth	Birth	1708-01-30
6	I1865	Munson, Mehitabel	female	Birth	Birth	1709-10-17
7	I1866	Munson, Sarah	female	Birth	Birth	1713-09-27
8	I1863	Munson, Elizabeth	female	Birth	Birth	1716-02-28

Hannah Munson Andrews b. 1697 d. 1785

It appears that Hannah was the last wife (the first being Lydia Johnson?) of Gideon Andrews. They may have married in 1739, and they may have had one child – Samuel (1742-?). I suspect that this branch of the mtDNA trail ends here.

Amy Munson Sperry b. 1704 d. ?

Amy married Joshua Sperry in about 1727 in New Haven. Their children seem to have included the following daughters – Rebecca (1730-?), Amy (1732-1748), Phebe (1735-1756), Sarah (1739-1740), Thankful (1740/1741-?), and Rachel (1746-1748). The ones that might have had children are analyzed below.

Rebecca Sperry Osborn b. 1730 d. ?

Rebecca Sperry married Jehiel Osborn (1728-?). They in turn had the following daughters –

- Amy (1750/1751-1761) did not live long enough to produce offspring.
- Rachel (1755-?) who married Michael Kenney,
- Lucy (1758-?) who married Zophar Atwater,

Tracing Ellen's mtDNA

- Rebecca (1764-1842) who married Elijah Hotchkiss,
- and Elizabeth (1772-?) who married Harmon Payne.

Amy Sperry b. 1732 d. 1748

Amy Sperry likely died in 1748 at about the age of 16. She shared a birthday (6/10) with her sister, Rebecca. I have found no marriage records, so I will assume that she had no children.

Phebe Sperry Downs b. 1735 d. ?

Phebe married Joseph Downs in 1756. They had a family in new haven Co., CT. All children but two were male. One female was Phebe (1765-1844) and the other was Candace (1756-?). Both daughters married men with the surname of Downs (!) and stayed in the New Haven area.

Thankful Sperry b. 1740 d. 1740?

I have found just the records of birth and baptism, separated by about 2 months. Other than this, there is no trace. I have a suspicion that this child did not survive long.

Tracing Ellen's mtDNA

Ruth Munson Hotchkiss b. 1708 d. 1785

Ruth married Caleb Hotchkiss in 1728 in New Haven. They had four children, one of whom was a daughter – Esther (b.1745).

Esther Hotchkiss Murray b. 1745 d. 1831

Esther married Philemon Murray and they had just one son, Hezekiah. This myDNA line ends here.

Tracing Ellen's mtDNA

Mehitabel Munson Morris b. 1709

Benjamin Munson (b. 1699) married Mehitabel in November of 1731. They had three children – two of whom were female.

Sarah Morris b. 1737 d. 1829?

Sarah married Judah Thompson and probably had just two children. One one a daughter named Rebecca Thompson (b. 1760). I can find no record of a marriage for this Rebecca, but I did find a potential death record – from phthisis (!) in 1829 in New Haven. I am inclined to accept this in lieu of other evidence. Taking that assumption, this branch of the mtDNA line end here.

Elizabeth Morris Humpreville b. 1739 d. ?

It appears that in 1759 Elizabeth Morris married Thomas Humphreville (b. 1736) in New Haven Co., CT. Their children were Lemuel (1760-?), Thomas (1762-1850), Elijah (1764-?), Elizabeth (1766-1825) who married Ezra Lines (1760-1820), and Mehitabel (1770-1806) who apparently was never married.

Tracing Ellen's mtDNA

Sarah Munson Stone b. 1713 d. 1737

Sarah married Enos Stone in 1731 and they had two children – Daniel (b. 1732) and Elizabeth (b. 1735).

Elizabeth Stone b. 1735 d. ?

I can find no record of what might have happened to Elizabeth. There are some potentially confusing similarly named people at this point in time. This is a line that could be investigated further.

Elizabeth Munson Perkins b. 1695 d. ?

Elizabeth married Seth Perkins (1685-1733) in 1716. Their children were Thomas (b. 1717), Amy and Eleanor.

Amy Perkins Peck b. 1726 d. 1799

Amy married Joseph Peck (1718-1788) in New haven. Their family consisted of the following. They mostly lived in the area of Woodbridge, CT.

Bathsheba Peck (1745-1832), who probably married Roswell Palmer (b. 1742)

Seth Peck (1747-1831)

Joseph Peck (1749-1800), who married Sarah Allcock (b. 1749)

Amy Peck (b.1751) who married Wilmot Bradley (1751-1814)

Dan Peck (b.1753)

John Peck (1756-1825), who married Lois Osborne.

Dorcas Peck (b.1758), who probably married William Osborne (b.1755).

Asenath Peck (1760-1838) , who married Stephen Russell (1756-1817)

Electa Peck (b.1761), who married John Alling (b.1761).

Henry Peck (b. 1764)

Rhoda Peck (1768-1770)

Eleanor Perkins Hotchkiss b. 1726 d. 1816

Eleanor married Solomon Hotchkiss (b.1724?) and lived in Woodbridge, CT. They had one daughter and two sons named Solomon (1752-1793) and David (1754-1823). Their daughter was Elizabeth Hotchkiss (b. 1749). Elizabeth married Daniel Johnson (b.1749).

Tracing Ellen's mtDNA

Mary Cooper Smith b. 1677 d. 1761 *

Samuel Smith and Mary Cooper headed another New haven Family. They were married in 1700. Their daughters were Obedience, Mary, Amy, Margaret, and Thankful.

Father/partner1		Mother/partner2	
Name:	Smith, Samuel [I0096]	Name:	Cooper, Mary [I1501]
Birth:	1678-05-14	Birth:	1677-09-04
Death:	1753-08-22	Death:	1761-06-01

Relationship Information

ID: Type:

Tags:

Children | Events | Source Citations | Attributes | Notes | Gallery | LDS

#	ID	Name	Gender	Paternal	Maternal	Birth Date
1	I1036	Smith, Lambertson	male	Birth	Birth	1701
2	I0119	Smith, Obedience	female	Birth	Birth	1705-05-19
3	I0117	Smith, Mary	female	Birth	Birth	1707-03-07
4	I1037	Smith, Amy	female	Birth	Birth	1708
5	I0094	Smith, Margaret	female	Birth	Birth	1711-06-26
6	I0118	Smith, Thankful	female	Birth	Birth	1712-09-30

Obedience Smith b. 1705 d. 1705

The consensus among researchers is that Obedience died not long after birth in New Haven.

Tracing Ellen's mtDNA

Mary Smith Painter b. 1707 d. 1786

Mary married one Deliverance Painter (1701-1781) on 6/23/1775 in New Haven. There is a sad story about the death of Deliverance that you can see at his memorial -

<https://www.findagrave.com/memorial/66645028>. Their family consisted of the following, including five daughters. Of these five, it appears that only one (Mary) had any children. The family lived in New Haven Co., CT.

- Samuel b. 1726 d. 1748
- Mary b. 1728 d. 1804
- Amy b. 1730 d. 1751
- Thomas b. 1733 d. 1755
- Abigail b. 1738 d. 1755
- Lamberton b. 1740 d. 1795
- Rebecca b. 1744 d. 1788
- Freelove b. 1749 d. 1751

Mary Painter Mallory b. 1728 d. 1804

Mary married Daniel Mallory (1720-?) in New Haven. It appears that they relocated to Litchfield Co., CT, where they had a large family that included the following daughters.

Abigail Mallory Curtiss (1748-?): Abigail married Israel Curtiss (1742-1802). They may have had a fairly large family, and they may have moved into Saratoga Co., NY. Their daughters included Polly (b. 1771), Charlotte (b. 1773), Mary (b. 1776), and Alatheia (b.1785).

Mary Mallory Curtiss (1749-10-17-?): I believe that Mary (like her sister) married a Curtiss (Stephen Curtiss 1744-1813) in Litchfield Co., CT. They also had a fairly large family, but most members stayed in CT. Her daughters included Amey (b. 1774), Mabel (b. 1778), Abigail (b. a780), Betsy (b.1783), Laura (b. 1790), and Louisa (b. 1792).

Note that there are two people named Mary Mallory/Mellery, living geographically very close (in Litchfield Co., CT), who are within a year of each other in age. The other Mary Mallory (b. 1748-06-23) was the daughter of John Mallory and probably Mary Sanford. She may have married a Simeon Minor (b. 1743) – who was also shadowed by a person with the same name in the same location but born about 7 years later.

Tracing Ellen's mtDNA

Freelove Amy Osborne (1752-1794): Married Jared Osborne (1745-1832). They had four children, and their family stayed in the Oxford area of New Haven Co., CT. There was one daughter named Electa (b. 1793).

Lois Mallory Chatfield (1756-1790?): Lois married Eli Chatfield (1754-1840) in Oxford, New Haven, CT. There were six children, one of whom (Sherman) may have made it to Illinois. The daughters included Mary (b. 1778), Obedience (b. 1782), Lucinda (b. 1784), and Polly (b.1788).

Adah Mallory (Hitchcok?) (1762-?): There is confusion among researchers about who Adah may have married. – For now I choose Caleb Hitchcock, but that should be confirmed. If this is true, then their children included the following daughters: Polly, Huldah, Leusinia, Esther, Adah, and Phila.

Rebecca Mallory Osborne (1764–1846): There is evidence that Rebecca married Nathan Orborne (1763-1845). They may have had a large family and at some point moved to NY. This is worthy of more research.

Mabel Mallory (1765-?): I can find no clear evidence regarding what became of Mabel. It is clear that she was born on 11/17/1765 to Daniel and Mary in Litchfield Co., CT.

Pene Mallory (1767-?): It is clear that Pene was born on 9/9/1767 to Daniel and Mary in Litchfield, but I can find no evidence about the rest of her life.

Amy Painter b. 1730 d. 1751

Died unmarried at only 21 years of age. She is buried in West Haven, New Haven, CT.

Abigail Painter b. 1738 d. 1755

Died unmarried at only 16 years of age. She is buried with her sister in West Haven.

Rebecca Painter b. 1744 d. 1788

I have seen in ancestry.com that there is suspicion that Rebecca married John Sherman (1734-1803). The evidence does appear to be strong, but if it is correct, they had just one child – Nathan Sherman (1767-1857). See https://www.ancestry.com/family-tree/person/tree/151746240/person/342011163400/facts?_phsrc=VqT14&_phstart=successSource . This is the only hint that I have had about Rebecca's life.

Freelove Painter b. 1749 d. 1751

This child died at about age 2 in West Haven, New Haven Co., CT.

Tracing Ellen's mtDNA

Amy Smith b. 1709 d. ?

It is clear that Amy was born 3/10/1709 in New Haven to Samuel Smith and Mary Cooper Smith. There is speculation that she died in 1709, or before 1715, or Her actual fate is unknown based on the evidence that I have seen. More work might be useful here.

Margaret Smith Smith(!) b. 1711 d. 1803 *

Here the trail is much clearer. Margaret married Austin Smith (1711-1797) in New Haven, CT, on 2/7/1733. They share one set of great grandparents, namely George Smith (1618-1662) and his wife Sarah Bourne (1614-1683), so they were second cousins. Their offspring are listed below and the daughters' families are examined in following sections.

- Philena Smith Hickok(x) (1750-1826)
- Margaret Smith Thompson (1734-1821)
- Mary Smith (1737-1773)
- Gad Smith (1740-1786)
- Austin Smith (1742-?)
- Hannah Smith (1747-?)
- Anthony Smith (1752-1838)
- Mehitabel Smith Benham (1755-1834)

Margaret Smith Thompson b. 1734 d. 1821

Margaret married Jonathan Thompson (1733-1784) in New haven Co., CT. Some researchers think that Jonathan's line can be traced back to the John Thompson that was Ellen's husband. There was another John Thompson in New Haven at the same time, however, and it seems more likely that this Jonathan Thompson's line leads back to him and his wife, Dorothy. This needs clarification, however. DNA analysis might ultimately be needed to separate of the Thompson lines (assuming that the two John Thompsons were not related).

In any event, Margaret and Jonathan had four children – Stephen (1759-?), Esther (1766-?), and Mary (?-1829).

Mary Thompson married David Hopkins. They lived in the Waterbury, CT, area and had a family that probably consisted of seven children, including three daughters (Polly, Mabel, and Laura).

Tracing Ellen's mtDNA

Mary Smith (Thompson?) b. 1737 d. 1773

There is speculation that Mary married Joel David Thompson (1737-1804). If that is the case, then there are a number of daughters to consider. This is VERY tentative, however. -

Mary (1763-?)

Sabra (1765-?)

Rachel (1767-?)

Asenath (1769-?)

Phebe (1773-?)

Hannah Smith Hickox b. 1746/1747 d. ?

There is speculation that Hannah (1746-?) married James Hickox(k) (1746-1833) on 11/28/1766 in New Haven. They may have had a daughter named Olive (1744-1806), who married a man named John Bouton.

Tracing Ellen's mtDNA

Philena Smith Hickox b. 1750 d. 1826 *

In the context of autosomal DNA matching results, Philena's family represents a likely practical limit to which autosomal DNA matching could be expected to yield a match worth pursuing. Someone descended from one of her children could theoretically share about 0.1% of autosomal DNA with me or my mother. The statistical nature of inheritance, however, means that a living person who shares a most recent common ancestor from this family may share no DNA or a little more than 0.1%.

In any event, Philena married Gideon Hickox (sometimes spelled Hickok). His family is seen elsewhere in this document, so my ancestors were well acquainted with his family for some time. The marriage

The screenshot shows a genealogy software interface. At the top, there are two columns for 'Father/partner1' and 'Mother/partner2'. Under 'Father/partner1', the name is 'Hickox, Gideon [I0040]', birth is '1752-05-04', and death is '1824-04-25'. Under 'Mother/partner2', the name is 'Smith, Philena [I0041]', birth is '1750', and death is '1826-11-17'. Below this is a 'Relationship Information' section with 'ID: F0015' and 'Type: Married'. At the bottom, there is a 'Children' section with a table of four children.

#	ID	Name	Gender	Paternal	Maternal	Birth Date
1	I0108	Hickox, David	male	Birth	Birth	1772-12-08
2	I0109	Hickox, Sara	female	Birth	Birth	1774-04-15
3	I0035	Hickox, Polly	female	Birth	Birth	1777-03-04
4	I1019	Hickox, Hannah Smith	female	Birth	Birth	1781-07-02

occurred on 8/29/1771 in Waterbury, New haven, CT.

There is evidence for just four children, all born in Waterbury. However, the family moved to Chenango Co., NY at some point. Chenango Co. is where Gideon and Philena are buried.

The families of their daughters and son are investigated below.

Sarah Hickox Beebe b. 1774 d. 1864

Sarah married Orillana Beebe (1770-1863), probably in CT. His name is spelled in an assortment of ways. They moved to Cortland Co., NY, and probably had quite a few children. Sarah and Orillana are both buried there.

Polly Hickox Warner b. 1777 d. 1849 *

Polly married Richard Warner while still in Waterbury in about 1792. They must have moved with her parents sometime between 1792 and 1802 based on the birth records for their children. My direct line maternal ancestor, Electa was born in Chenango Co., on 2/2/1802. It is her marriage to John Edwin

Tracing Ellen's mtDNA

Robbins Jr. that produces the first first family for which I have some pictures. This Robbins/Warner family lived in Crawford Co., PA.

Hannah Smith Hickox Terrill b. 1781 d. 1856

Hannah married Elias Terrill (1766-1835) in New haven Co., CT, on 5/6/1798. They probably had a large family – some born in CT and others born in NY. (They eventually moved to Chenango Co., NY.

David Hickox b. 1772 d. 1847

David married Kezia Dutton (1783-1865), They lived in Litchfield Co., CT, and they had one son named Caleb.

Tracing Ellen's mtDNA

Mehitabel Smith Benham b. 1755 d. 1834

Mehitabel married Elihu Benham (1748-1836) . They lived in New haven Co., CT, and they had a family consisting of the following children (or something close to this?). (There is disagreement about the children.) Once again, this was a New Haven Family.

- Mehitabel (1773-?): married Zebah Farrell (1776-1862), had a family and remained in the New Haven Co., CT, area.
- Sally (1775-1862): She may have died 2/19/1862 in New Haven Co., CT. And, she may have been married to one Jacob Monroe on 3/12/1793.
- Elihu (1777-1862)
- Laurena (1785?-?): unknown fate.
- Leverett (1799-1851)
- Ransom (1790-1860)
- Philena (1791-?): unknown fate.
- Barzil (1795-1878)
- Lewis (1796-1885)
- Desire (1798-1803)

The information for this family is VERY tentative and could benefit form more research.

Tracing Ellen's mtDNA

Thankful Smith Tolles b. 1712 d. 1769

Thankful married Daniel Tolles (1705-1782) probably in the early 1730s. (Some people have confused her with her daughter, Thankful Tolles, who married Daniel Sanford.)

Thankful Smith and Daniel Tolles lived in New Haven Co., CT, where they may have had an impressive array of children. Estimates include the list of twelve in the accompanying picture.

Assuming this list is correct, there were four daughters to investigate: Thankful, Dorothy, Desire, and Mary.

Father/partner1

Name: Tolles, Daniel [I1587]
 Birth: 1705
 Death: 1782-06-20

Mother/partner2

Name: Smith, Thankful [I0118]
 Birth: 1712-09-30
 Death: 1769-06-28

Relationship Information

ID: Type:

Tags:

Children Events Source Citations Attributes Notes Gallery LDS

#	ID	Name	Gender	Paternal	Maternal	Birth Date
1	I1588	Tolles, Thankful	female	Birth	Birth	1737
2	I1589	Tolles, Nehemiah	male	Birth	Birth	1739
3	I1590	Tolles, Daniel	male	Birth	Birth	1741
4	I1591	Tolles, Lazarus	male	Birth	Birth	1743
5	I1592	Tolles, Dorothy	female	Birth	Birth	1745
6	I1593	Tolles, Desire	female	Birth	Birth	1745
7	I1594	Tolles, Titus	male	Birth	Birth	1746
8	I1595	Tolles, Daniel	male	Birth	Birth	1748
9	I1596	Tolles, Lambertson	male	Birth	Birth	1750
10	I1597	Tolles, Jared	male	Birth	Birth	1752
11	I2064	Tolles, Abraham	male	Birth	Birth	1754
12	I2065	Tolles, Mary	female	Birth	Birth	1756

Tracing Ellen's mtDNA

Thankful Tolles Sanford b. 1737 d. 1820

This Thankful married Daniel Sanford. It appears that they were married in Waterbury and ended up in Litchfield Co., CT. Their last son (Eli) made it to Ashtabula, OH.

Daughters of interest follow.

Father/partner1

Name: Sanford, Daniel [I1598]
 Birth: 1730
 Death: 1777

Mother/partner2

Name: Tolles, Thankful [I1588]
 Birth: 1737
 Death: 1820

Relationship Information

ID: Type:

Tags:

Children

#	ID	Name	Gender	Paternal	Maternal	Birth Date
1	I1600	Sanford, Irenah	female	Birth	Birth	1753-11-07
2	I2066	Sanford, Thankful	female	Birth	Birth	1755
3	I1601	Sanford, Ezekial	male	Birth	Birth	1757-11-25
4	I1602	Sanford, lois	female	Birth	Birth	1760-06-15
5	I1603	Sanford, Phoebe	female	Birth	Birth	1762-09-20
6	I1599	Sanford, Eli	male	Birth	Birth	1767-02-28

Irenah Sanford (1753-1830?): Irenah probably married Samuel Fenn (1743-1820) in 1767. There are multiple Samuel Fenns around at about this time, but this appears to be the correct one. That being the case, their children were likely included . . . Irena (1768-1830), Samuel (1770-1854), Eli (1772-1822), Thankful (1776-1829), and Anna (1778-?). Litchfield Co., CT, looks to have been their final home area.

Thankful Sanford (1755-1759): This Thankful did not survive long enough to have offspring.

Lois Sanford (1760-1832): Lois married Daniel Curtis (1754-1803) in 1776. They lived in Litchfield Co., CT, and had three children – Polly (1782-?), who married Isaac Newton (I did not make that up.), Eli (1786-?), and Philena (1779-?).

Phebe Sanford (1762-?): Phoebe married Samuel Martin (1759-?). They started in CT and eventually ended up in Broome Co., NY. Their children included these daughters: Fanny, Phebe, and Charlotte.

Tracing Ellen's mtDNA

Dorothy Tolles b. 1745 d. 1745?

I find nothing other than a record of Dorothy's baptism on 12/8/1745 in Nrew Haven Co., CT. My suspicion is that Dorothy was a twin to Desire and that Dorothy did not survive.

Desire Tolles Beecher b. 1745 d. 1812

Desire married Isaac Beecher on 4/28/1768. They had a large family that included the following daughters Frances, Elizabeth, and Betsy. Some children, as well as Isaac ended up in Litchfield Co., CT.

Mary Tolles Thomas b. 1756 d. 1842

Mary married Noah Thomas (1756-1818) in Oxford, CT., on 9/8/1781. They had six children, only one of which was female, namely Laura, who may have married Elihu Roninson.

Tracing Ellen's mtDNA

Abigail Cooper Johnson b. 1679 d. 1724

Abigail and her husband Isaac had just one daughter (Eunice). They were married in 1699 and lived in New Haven.

Father/partner1		Mother/partner2				
Name:	Johnson, Isaac [I1519]	Name:	Cooper, Abigail [I0120]			
Birth:	1672	Birth:	1679-10-03			
Death:	1750	Death:	1724-12-06			
Relationship Information						
ID:	<input type="text" value="F0393"/>	Type:	<input type="text" value="Married"/>			
Tags:						
Children Events Source Citations Attributes Notes Gallery LDS						
+ 📄 📝 - ⬆️ ⬇️						
#	ID	Name	Gender	Paternal	Maternal	Birth Date
1	I1520	Johnson, Eunice	female	Birth	Birth	1703
2	I1521	Johnson, David	male	Birth	Birth	1721











Eunice Johnson (Sperry?) b. 1703 d. 1725

Eunice died quite early in life (age 22). Only one source indicates that she may have married Asa Sperry, but I can find no confirmation of this. For now, I assume that Eunice died “without issue.”

Tracing Ellen's mtDNA

Hannah Cooper Lines b. 1681 d. 1772

Hannah and her husband John Lines had just one daughter (Kezia).

Father/partner1  	Mother/partner2  					
Name: Lines, John [I1497]	Name: Cooper, Hannah [I1502]					
Birth:	Birth: 1681-08-10					
Death:	Death: 1772-11-11					
Relationship Information						
ID: <input type="text" value="F0396"/>	Type: <input type="text" value="Married"/>					
Tags:						
Children      						
Events Source Citations Attributes  Notes Gallery LDS						
#	ID	Name	Gender	Paternal	Maternal	Birth Date
1	I1529	Lines, Kezia	female	Birth	Birth	1715-04-05

Tracing Ellen's mtDNA

Kezia Lines Alling b. 1715 d. 1782

Kezia (1715-1782) married Samuel Alling (1712/1715-1799) in about 1737 in New Haven. Their children consisted of those in the accompanying picture.

Father/partner1				Mother/partner2			
Name:	Alling, Samuel [I1977]			Name:	Lines, Kezia [I1529]		
Birth:	1715			Birth:	1715-04-05		
Death:	1788			Death:	1782-01-12		
Relationship Information							
ID:	F0486			Type:	Married		
Tags:							
Children Events Source Citations Attributes Notes Gallery LDS							
+ [Icons]							
#	ID	Name	Gender	Paternal	Maternal	Birth Date	
1	I1978	Alling, Ruth	female	Birth	Birth	1738-10-08	
2	I1979	Alling, Roger	male	Birth	Birth	1741	
3	I1980	Alling, Samuel	male	Birth	Birth	1743	
4	I1981	Alling, Amos	male	Birth	Birth	1745	
5	I1982	Alling, Kezia	female	Birth	Birth	1748-11-26	
6	I1983	Alling, Cornelius	male	Birth	Birth	1748	
7	I1984	Alling, Eleanor	female	Birth	Birth	1751-11-27	
8	I1985	Alling, Hannah	female	Birth	Birth	1751-11-27	
9	I1986	Alling, Gideon	male	Birth	Birth	1754	
10	I1987	Alling, John	male	Birth	Birth	1756	

Ruth Alling Hine b. 1738 d. 1777

Daughter Ruth married Daniel Hine (1734-1798). Their daughters were Mary (1757-?), Kezia (1759-?), Rebecca (1760-?), Eunice (1760-?), Elizabeth (1765-?), and Hannah (1767-?). The history of this family seems a little confusing and poorly defined. The daughters warrant more research.

I have not found more data about Mary Hine (b. 1757). She deserves more research.

It appears that Kezia Hine married Timothy Goodrich (1756-1829). They ended up in VT.

Rebecca Hine (b. 1760) may have married a Hubbard person and moved to VT. She seems to be buried next to her sister, Elizabeth, in Rutland Co., VT. See memorial: <https://www.findagrave.com/memorial/46521466/elizabeth-hine> .

Tracing Ellen's mtDNA

Eunice Hine (b. 1760) seems to have married Jonathan Orms. They lived in Rutland Co.,VT, and had a large family.

Elizabeth Hine likely was not married and died in VT. See info about her sister Rebecca above.

Kezia Alling b. 1748 d. 1765

Daughter Kezia(h) died at about the age of 17 so I assume that she did not marry and so had no children. She was Cornelius' twin sister.

Eleanor Alling Frisbie b. 1751 d. ?

Eleanor married Amos Frisbie. They lived in New Haven.

Hannah Alling Peck b. 1751 d. ?

Hannah married Seth Peck. They also lived in the New Haven area. We have seen the Peck name elsewhere.

Tracing Ellen's mtDNA

Rebecca Cooper Alling b. 1689 d. 1770

Rebecca
married
Daniel Alling,
and they had a
daughter
named Phebe.

Father/partner1		Mother/partner2				
Name: Alling, Daniel [11525]	Birth: 1688	Name: Cooper, Rebecca [10122]	Christening: 1689-08-24			
Death: 1756		Death: 1770-01-02				
Relationship Information						
ID: F0395	Type: Married					
Tags:						
Children Events Source Citations Attributes Notes Gallery LDS						
+ - ↑ ↓						
#	ID	Name	Gender	Paternal	Maternal	Birth Date
1	I1526	Alling, Timothy	male	Birth	Birth	1712
2	I1527	Alling, Phebe	female	Birth	Birth	1723
3	I1528	Alling, Silas	male	Birth	Birth	1734-09-11

Phebe Alling Talmadge Wolcott b. 1723 d. 1788

Phebe was married twice – first to Robert Talmadge in 1747 and then to William Wolcott sometime after 1754 by current estimates.

I can not find any children that Phebe had with Robert Talmadge (1715-1753). They were only married about 6 years before he died.

With William Wolcott (1730-1784) Phebe apparently had the following children, two of whom could have furthered the mtDNA line.

- Phebe (1755-1832)
- William (1756-1782)
- Eunice (1757-1759)
- Rebecca (1759-1838)
- Benajah (1762-1832)
- Timothy (1763-1767)

Father/partner1		Mother/partner2				
Name: Wolcott, William [11952]	Birth: 1736	Name: Alling, Phebe [11527]	Birth: 1723-03-24			
Death: 1788		Death: 1788-04-23				
Relationship Information						
ID:	Type: Married					
Tags:						
Children Events Source Citations Attributes Notes Gallery LDS						
+ - ↑ ↓						
#	ID	Name	Gender	Paternal	Maternal	Birth Date
1	I1953	Wolcott, Phebe	female	Birth	Birth	1755-05-18
2	I1954	Wolcott, Willaim	male	Birth	Birth	1756-10-03
3	I1955	Wolcott, Eunice	female	Birth	Birth	1757
4	I1956	Wolcott, Rebecca	female	Birth	Birth	1759-08-19
5	I1957	Wolcott, Benajah	male	Birth	Birth	1762-04-07
6	I1958	Wolcott, Timothy	male	Birth	Birth	1763

Tracing Ellen's mtDNA

Phebe Wolcott Barney b. 1755 d. 1832

Here's a name that I have not encountered before – Barney. Phebe married Hanover Barney (1750-1839) in New Haven in 1775. They had the following children. It appears that the family stayed in the New Haven area.

- William (1777-1870)
- Silence (1770-1805) – married Elihu Munson (1774-1852)
- Anna (1781-?)
- Charles (1783-?)
- James (1785-?)
- Susan (1787-?)
- Lebbeus (1790-1795)
- Phebe (1792-?)
- Elizabeth (1794-?)
- Mary Ann (1799-?)

Rebecca Wolcott Turner b. 1759 d. 1838

Rebecca married one Jabez Turner (1756-1846) in New haven in 1788. Their children are listed below. Some of these children probably migrated out of CT.

- Zina (?-?)
- Timothy (?-?)
- Jerusha (?-?)
- Beauajah (1779-1872)
- William (?-?)
- Bela (1788-1879)

Tracing Ellen's mtDNA

Sarah Thompson Alling b. 1654 d. 1716

Here is a list of Sarah's descendants for 3 generations.

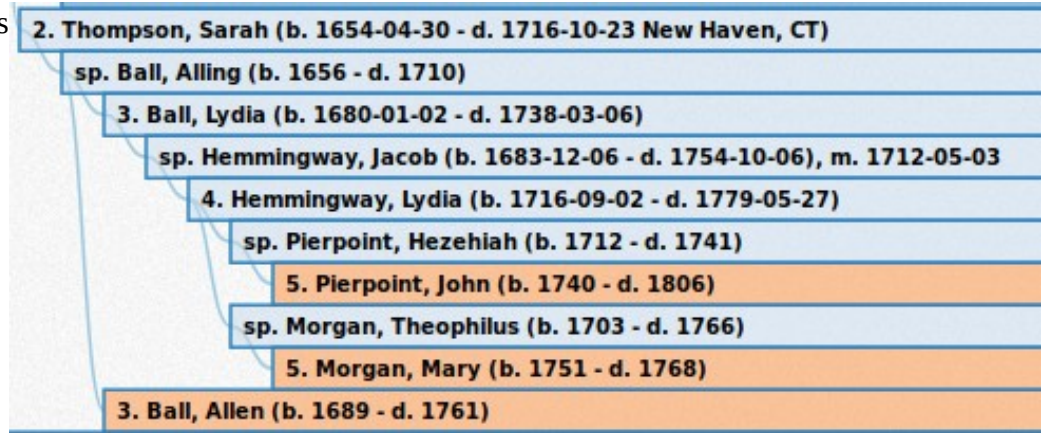

The end of the mtDNA line here is with Mary Morgan, who died at age 16 in Clinton, CT.

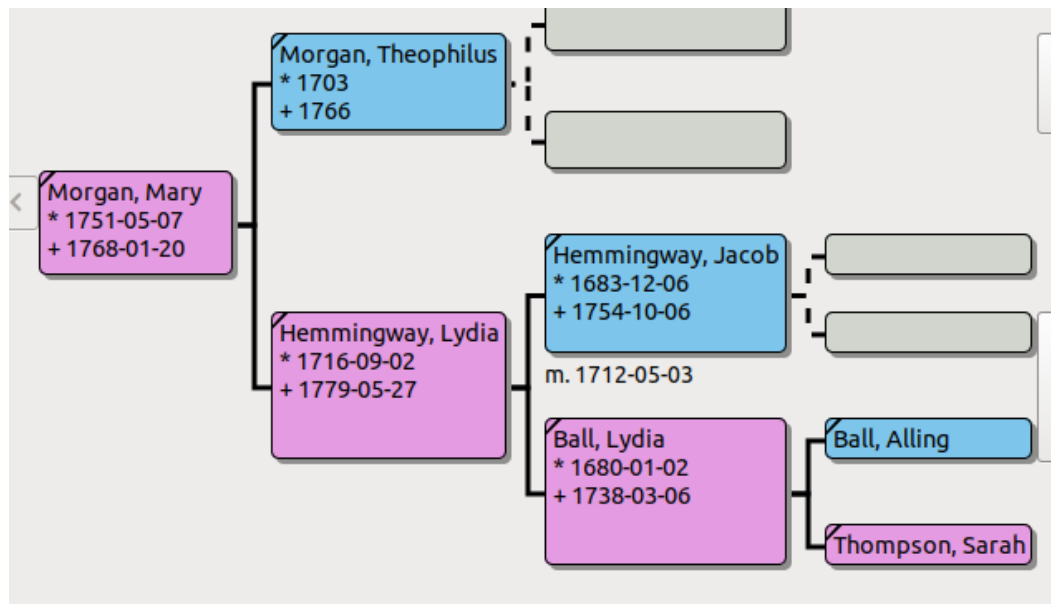

Tracing Ellen's mtDNA

Undocumented Lines (Dead-ends)

Along Hannah Thompson's Line

The daughters of Mabel Russell and Benjamin Utter

They appear to have had two daughters, for whom I have found no descendants or death records. This was a family in East Haven, CT, which is where Mabel Russell seems to have been buried in 1782. These daughters are listed below.

Mary Utter b. 1737

Mabel Utter b. 1765

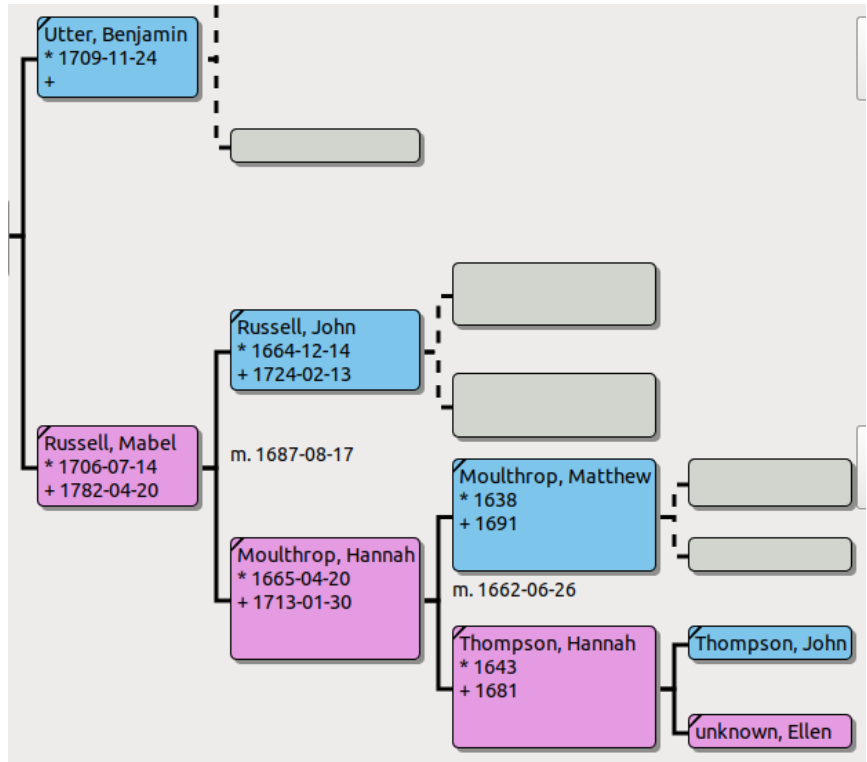

Tracing Ellen's mtDNA

Sarah Utter (b.1730), daughter of Lydia Russell (b. 1692) and Abraham Utter (b. 1688)

There is conflicting information about the fate of Sarah. She may have died within a year of birth or she may have married Phillip Knight of Rhode Island, where she died in 1759, after having two daughters – Phebe (b. 1756) and Sarah (b. 1757). Requires more careful research to get a better idea of the truth.

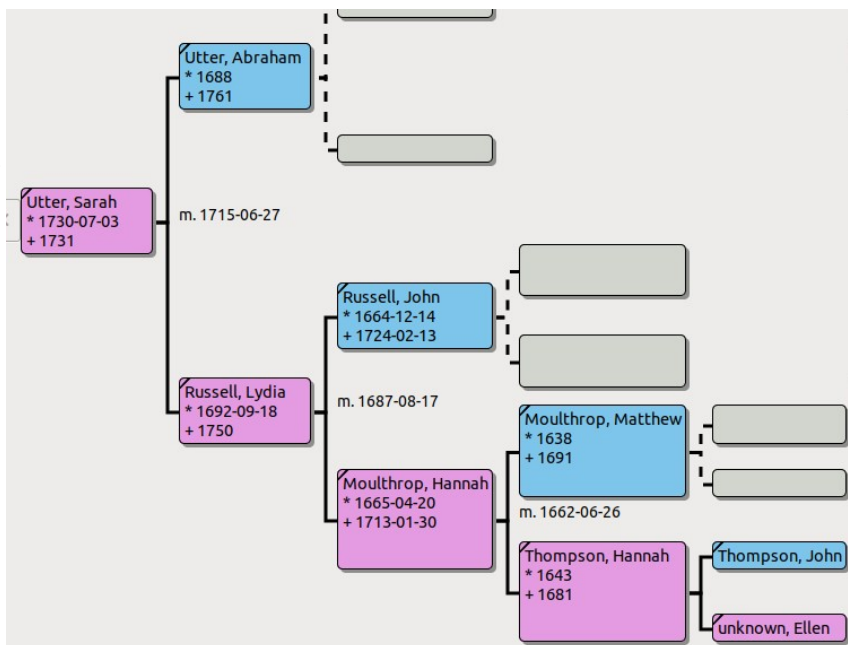

Abigail Hodges (b. 1731), daughter of Abigail Russell (b. 1701) and Abraham Hodges (b. 1697)

I have found nothing other than a birth record, so she warrants more research.

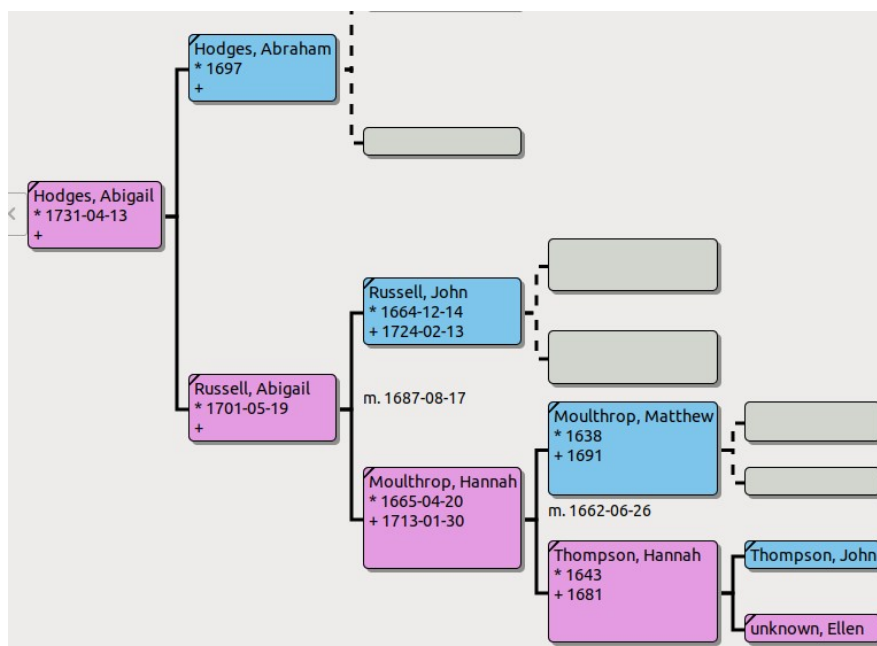

Tracing Ellen's mtDNA

First Daughter of Sarah Shepard Chidsey (b.1728), Hannah Chidsey (b. 1747)

I have been unable to trace much information for this individual. There is a reference to Dodd's East Haven (register?) to indicate a death in 1840! More work is needed here to get a clear picture, if possible.

Sarah Chidsey (b. 1758), daughter of Sarah Shepard (b. 1728) and John Chidsey (b. 1720)

Sarah appears to have been married to Richard Barrett in East haven, CT, on 1/13/1780. However, it is not clear whether they had children. In fact it is not at all clear that this is a correct association. More investigation is required.

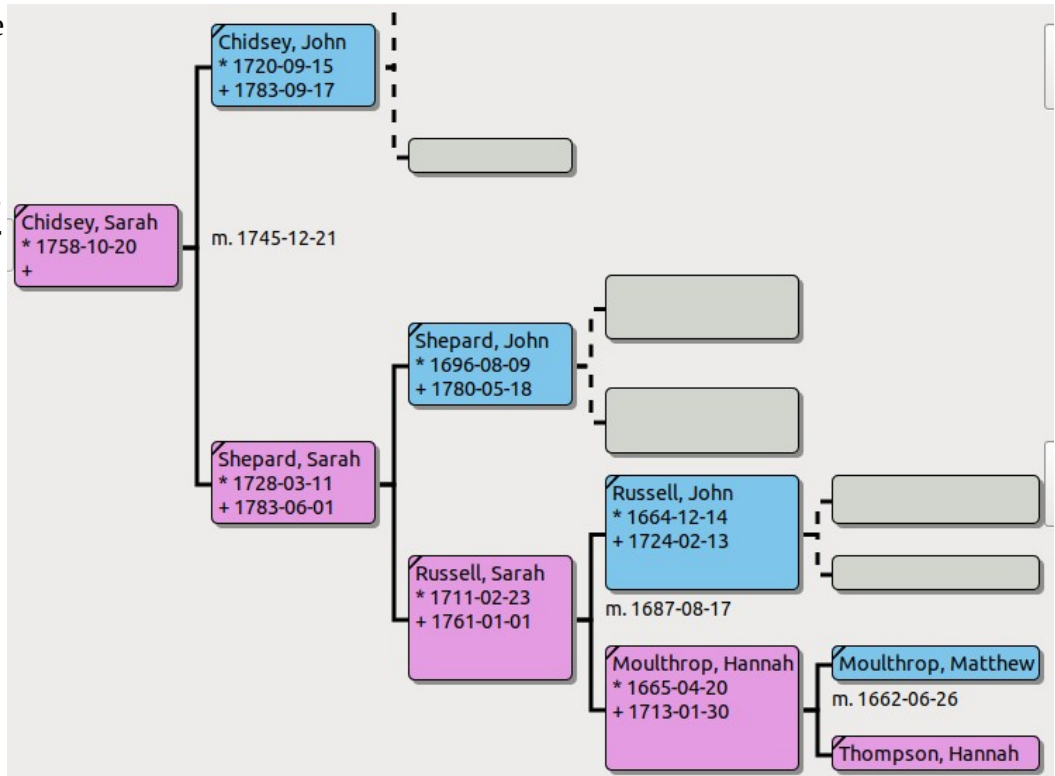

Rhoda Chidsey (b. 1764), daughter of Sarah Shepard (b. 1728) and John Chidsey (b. 1720)

Rhoda may have married William Seymour and ended up in Delaware Co., NY. If so, she had daughters. However, all that is available online that I can find appears to be hearsay. More work is needed here.

Tracing Ellen's mtDNA

Mary Shepard's Identity(ies)

I am afraid that there is confusion in the ranks over two families - one headed by Mary Shepard and David Grannis, offspring of Russell and Lydia (Forbes) Grannis and Thomas and Sarah (Hotchkiss) Shepard. The children of this marriage are often listed with the same names as the one from the other marriage - that being between Sarah Russell (daughter of John and Sarah (Russell) Shepard) and the same David Grannis.

The issue of the two Mary's needs to be resolved before anything can be confidently concluded about marriages and offspring.

References:

The Church of Jesus Christ of Latter-day Saints, "International Genealogical Index (IGI)," database, FamilySearch (<https://familysearch.org/ark:/61903/2:1:M6YR-8N1> : accessed 9 February 2019), entry for Mary Shepard, batch A22760-7; citing FHL microfilm 455,111; submitter not specified.

"Pedigree Resource File," database, FamilySearch (<https://familysearch.org/ark:/61903/2:2:SB1J-9LL> : accessed 9 February 2019), entry for Mary /Shepard/, cites sources; file (2:2:2:MMW8-HB9), submitted 15 May 2011.

Esther Palmer (b. 1751), daughter of Lydia Barker Palmer (b. 1712)

I have been unable to locate any information other than a birth record for this individual, who was born in Branford, CT.

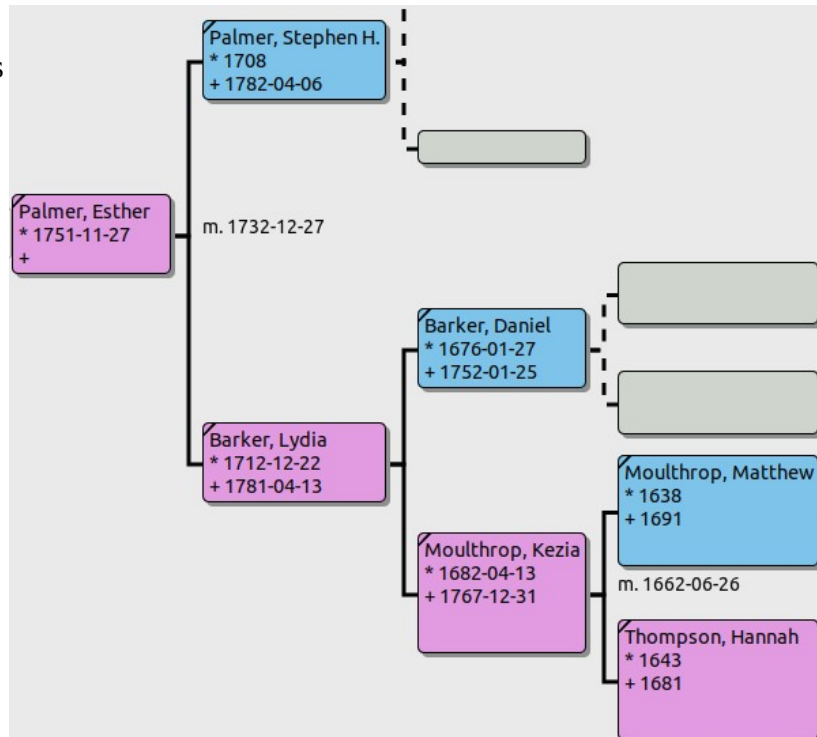

Tracing Ellen's mtDNA

Along Rebecca Thompson's Line

Elizabeth / Betsy Booth b. 1753

Daughter Esther had just a daughter, Elizabeth – born in Fairfield Co., CT. However there is confusion in the compiled records about another daughter named Betsy, who might actually be Elizabeth. If they are the same person, she likely married Hezekiah Sanford (?-1834?) and eventually died in Hartford Co., CT.

Sarah Gilbert (1758-?)

It seems clear that Sarah was a daughter of Eunice Todd and John Gilbert. However, I can find no clear evidence of her marriage or death. She would be easily confused with Sarah Gilbert (b. 9/9/1758) to Hezekiah Gilbert and his with Tameson Gregory in Fairfield Co., CT. More research could be done on this.

Her birth family in fact is somewhat uncertain because of research confusion. There is some confusion that may stem from the existence of two John Gilberts and/or two wives (Eunice Todd versus Lydia Ives). I was not able to sort out the conflicting views of history.

Mary Peck b. 1758 d. ?

I can find no clear records for Mary other than the record of her birth in New Haven Co., CT. More research is needed.

Pamela Peck b. 1761 d. ?

I can find no clear records for Pamela. Just one pedigree submission mentions her. - "Pedigree Resource File," database, *FamilySearch* (<https://familysearch.org/ark:/61903/2:2:SBQK-7FM> : accessed 15 February 2019), entry for Pamela /Peck/; file (2:2:2:MM7Y-Z63), submitted 14 May 2011 by shalom [identity withheld for privacy].

Mary Dinah Peck b. 1767

I can find no clear records for this Mary other than the record of her birth, which shows her name as Mary Dinah. More research is needed.

Tracing Ellen's mtDNA

Along Mary Thompson's Line

Elizabeth Stone b. 1735 d. ?

I can find no record of what might have happened to Elizabeth. This is a line that could be investigated further.

Mary (1757? -?), the Daughter of Ruth Alling Hine b. 1738 d. 1777

Daughter Ruth married Daniel Hine (1734-1798). Their daughters were Mary (1757-?), Kezia (1759-?), Rebecca (1760-?), Eunice (1760-?), Elizabeth (1765-?), and Hannah (1767-?). The history of this family seems a little confusing and poorly defined. The daughters warrant more research.

I have not found more data about Mary Hine (b. 1757). She deserves more research.

It appears that Kezia Hine married Timothy Goodrich (1756-1829). They ended up in VT.

Rebecca Hine (b. 1760) may have married a Hubbard person and moved to VT. She seems to be buried next to her sister, Elizabeth, in Rutland Co., VT. See memorial: <https://www.findagrave.com/memorial/46521466/elizabeth-hine> .

Eunice Hine (b. 1760) seems to have married Jonathan Orms. They lived in Rutland Co., VT, and had a large family.

Elizabeth Hine likely was not married and died in VT. See info about her sister Rebecca above.

Eunice Johnson (Sperry?) b. 1703 d. 1725

Eunice died quite early in life (age 22). Only one source indicates that she may have married Asa Sperry, but I can find no confirmation of this. For now, I assume that Eunice died "without issue." However, this could be investigated. There may be another mtDNA line here.

Rebecca Painter (Sherman?) b. 1744 d. 1788

I have seen in ancestry.com that there is suspicion that Rebecca married John Sherman (1734-1803). The evidence does appear to be strong, but if it is correct, they had just one child – Nathan Sherman (1767-1857). See https://www.ancestry.com/family-tree/person/tree/151746240/person/342011163400/facts?_phsrc=VqT14&_phstart=successSource . This is the only hint that I have had about Rebecca's life. Given the lack of certainty, more research may be worthwhile.

Tracing Ellen's mtDNA

Amy Smith b. 1709 d. ?

It is clear that Amy was born 3/10/1709 in New Haven to Samuel Smith and Mary Cooper Smith. There is speculation that she died in 1709, or before 1715, or Her actual fate is unknown based on the evidence that I have seen. More work might be useful here.

Mary Smith (Thompson?) b. 1737 d. 1773

There is speculation that Mary married Joel David Thompson (1737-1804). If that is the case, then there are a number of daughters to consider. This is VERY tentative, however. -

Mary (1763-?)

Sabra (1765-?)

Rachel (1767-?)

Asenath (1769-?)

Phebe (1773-?)

This could be researched to resolve the uncertainty.

Tracing Ellen's mtDNA

Descendants of Ellen Thompson and John Thompson – until 1800 +/-

1. unknown, Ellen (b. 1621 - England, d. - New Haven, Connecticut)
sp. Thompson, John (b. 1617 - England, d. 1656)
2. Thompson, John Jr. (b. 1641, d. 1693-02-13)
sp. Powell, Priscilla (b. 1643, d. 1726)
 3. Thompson, John (b. 1667, d. 1721)
 3. Thompson, Priscilla (b. 1673, d. 1728)
 3. Thompson, Samuel (b. 1677, d. 1712)
 3. Thompson, Abigail (b. 1680)
 3. Thompson, Joseph (b. 1710, d. 1728)
2. Thompson, Mary (b. 1642-04-24 - New Haven, Connecticut, d. 1714-11-17 - New Haven, Connecticut)
sp. Cooper, John Junior (b. 1642-05-28 - New Haven, Connecticut, d. 1703 - New Haven, Connecticut)
 3. Cooper, Rebecca (b. 1666, d. 1668)
 3. Cooper, unknown (b. 1668, d. 1668)
 3. Cooper, Mary (b. 1669-11-15 - New Haven, Connecticut, d. 1670-04-22 - New Haven, Connecticut)
 3. Cooper, John (b. 1670-02-23 - New Haven, Connecticut)
sp. Thomas, Sarah (b. 1672)
 4. Cooper, Elizabeth (b. 1694, d. 1776)
 3. Cooper, Sarah (b. 1673-04-26, d. 1736)
sp. Munson, John (b. 1672-01-28 - New Haven, Connecticut, d. 1749)
 4. Munson, John (b. 1693-07-07)
 4. Munson, Hannah (b. 1697-02-09, d. 1785)
sp. Andrews, Gideon (d. 1746)
 5. Andrews, Samuel (b. 1742)
 4. Munson, Joel (b. 1702-08-18, d. 1776)
 4. Munson, Amy (b. 1704-09-18)
sp. Sperry, Joshua (b. 1700, d. 1777)
 5. Sperry, Caleb (b. 1728, d. 1799)
 5. Sperry, Rebecca (b. 1730-06-10 - New Haven, Connecticut)
sp. Osborne, Jehiel (b. 1728)
 6. Osborne, Amy (b. 1751, d. 1761)
 6. Osborne, Medad (b. 1753, d. 1814)
 6. Osborne, Rachel (b. 1755-10-14)
sp. Kenney, Michael
 6. Osborne, Lucy (b. 1758, d. 1849)
sp. Atwater, Zophar (b. 1756, d. 1810)
 6. Osborne, Elisha (b. 1761, d. 1808)
 6. Osborne, Rebecca (b. 1764, d. 1842)
sp. Hotchkiss, Elijah (b. 1762, d. 1849)
 6. Osborne, Elizabeth (b. 1772)
sp. Payne, Harmon (b. 1773, d. 1816)
 5. Sperry, Amy (b. 1732-06-10 - New Haven, Connecticut, d. 1748-10-16)
 5. Sperry, Joshua (b. 1734, d. 1759)
 5. Sperry, Phebe (b. 1735-02-18)
sp. Downs, Joseph (b. 1732)
 6. Downs, Candace (b. 1756)

Tracing Ellen's mtDNA

6. Downs, Laben (b. 1758, d. 1782)
6. Downs, Zephaniah (b. 1760, d. 1785)
6. Downs, Joshua (b. 1762)
6. Downs, Phebe (b. 1765, d. 1844)
6. Downs, Seth (b. 1767)
6. Downs, Adda (b. 1769, d. 1794)
6. Downs, Edward (b. 1773, d. 1853)
6. Downs, Joseph (b. 1775)
6. Downs, Eli (b. 1777)
5. Sperry, Sarah (b. 1739, d. 1740)
5. Sperry, Thankful (b. 1740-02-16, d. 1740)
5. Sperry, Lent (b. 1743, d. 1823)
5. Sperry, Rachel (b. 1746, d. 1748)
4. Munson, Ruth (b. 1707-01-30, d. 1785-05-21 - New Haven, Connecticut)
 - sp. Hotchkiss, Caleb (b. 1703, d. 1785)
 5. Hotchkiss, Hezekiah (b. 1729, d. 1761)
 5. Hotchkiss, John (b. 1731, d. 1779)
 5. Hotchkiss, Joshua (b. 1734, d. 1795)
 5. Hotchkiss, Esther (b. 1745, d. 1831)
 - sp. Murray, Philemon (b. 1747, d. 1791)
 6. Murray, Hezekiah (b. 1774, d. 1849)
 4. Munson, Mehitabel (b. 1709-10-17, d. 1779-02-26 - New Haven, Connecticut)
 - sp. Morris, Benjamin (b. 1699)
 5. Morris, Sarah (b. 1737-03-15)
 - sp. Thompson, Judah (b. 1713)
 6. Thompson, Rebecca (b. 1760-01-03, d. 1829-10-24)
 6. Thompson, Judah (bap. 1764-04-08)
 5. Morris, Elizabeth (b. 1739-04-10)
 - sp. Humphreville, Thomas (b. 1736)
 6. Humphreville, Lemuel (b. 1760)
 6. Humphreville, Thomas (b. 1762, d. 1850)
 6. Humphreville, Elijah (b. 1764)
 6. Humphreville, Elizabeth (b. 1766-11-10, d. 1825-10-09 - Fairfield, Connecticut)
 - sp. Lines, Ezra (b. 1760, d. 1820)
 6. Humphreville, Mehitabel (b. 1770-10-02, d. 1806-09-25)
 5. Morris, John (b. 1741)
 4. Munson, Sarah (b. 1713-09-27, d. 1737)
 - sp. Stone, Enos (b. 1709, d. 1758)
 5. Stone, Daniel (b. 1732)
 5. Stone, Elizabeth (b. 1735-07-01)
 4. Munson, Elizabeth (b. 1695-05-15)
 - sp. Perkins, Seth (b. 1685, d. 1733)
 5. Perkins, Thomas (b. 1717, d. 1758)
 5. Perkins, Amy (b. 1726-09-03, d. 1799-06-02)
 - sp. Peck, Joseph (b. 1718, d. 1788)
 6. Peck, Bathsheba (b. 1745, d. 1832)
 - sp. Palmer, Roswell (b. 1742)
 6. Peck, Seth (b. 1747, d. 1831)
 6. Peck, Joseph (b. 1749, d. 1800)
 6. Peck, Amy (b. 1751)
 - sp. Bradley, Wilmot (b. 1751, d. 1814)
 6. Peck, Dan (b. 1753)

Tracing Ellen's mtDNA

6. Peck, John (b. 1756, d. 1825)
6. Peck, Dorcas (b. 1758)
sp. Osborne, William (b. 1755)
6. Peck, Asenath (b. 1760, d. 1838)
sp. Russell, Stephen (b. 1756, d. 1817)
6. Peck, Electa (b. 1761)
sp. Alling, John (b. 1756, d. 1831)
6. Peck, Henry (b. 1764)
6. Peck, Rhoda (b. 1768, d. 1770)
5. Perkins, Eleanor (b. 1726-09-03, d. 1816-05-09)
sp. Hotchkiss, Solomon (b. 1724)
 6. Hotchkiss, Elizabeth (b. 1749)
sp. Johnson, Daniel (b. 1749)
 6. Hotchkiss, Solomon (b. 1752, d. 1793)
 6. Hotchkiss, David (b. 1754, d. 1823)
3. Cooper, Samuel (b. 1675-06-20, d. 1762-01-26)
sp. Smith, Elizabeth
 4. Cooper, Mabel
 4. Cooper, Samuel
 4. Cooper, Isaac
 4. Cooper, Desire
 4. Cooper, Obedience
 4. Cooper, Joel
 4. Cooper, Sarah
 4. Cooper, Abraham Sr.
3. Cooper, Mary (b. 1677-09-04, d. 1761-06-01)
sp. Smith, Samuel (b. 1678-05-14 - New Haven, Connecticut, d. 1753-08-22 - New Haven, Connecticut)
 4. Smith, Lamberton (b. 1701, d. 1779)
 4. Smith, Obedience (b. 1705-05-19 - New Haven, Connecticut, d. 1705)
 4. Smith, Mary (b. 1707-03-07, d. 1786-05-29)
sp. Painter, Deliverance (b. 1701-05-31, d. 1781-09-01)
 5. Painter, Samuel (b. 1726, d. 1748)
 5. Painter, Mary (b. 1727-01-14 - New Haven, Connecticut, d. 1804-01-13 - Litchfield, Connecticut)
 - sp. Mallory, Daniel (b. 1719-01-02, d. 1790)
 6. Mallory, Abigail (b. 1748-01-18 - Litchfield, Connecticut)
sp. Curtis, Israel (b. 1742-04-24 - Litchfield, Connecticut, d. 1802-08-28 - Saratoga, New York)
 7. Curtis, Truman (b. 1770, d. 1803)
 7. Curtis, Polly (b. 1771)
 7. Curtis, Charlotte (b. 1773-10-30 - Woodbury, Litchfield, Connecticut, d. 1848-12-17 - Tompkins County, NY, New York)
sp. Ball, Lebbeus Jr.
 8. Ball, Stephen C. (b. 1797, d. 1871)
 8. Ball, Alvin Munn (b. 1798, d. 1872)
 8. Ball, Charlotte (b. 1802)
 8. Ball, Calvin Stowe Sr. (b. 1798, d. 1832)
 8. Ball, Betsy (b. 1800, d. 1891)
 7. Curtis, Mary (b. 1776-02-24 - Litchfield, Connecticut, d. 1849-04-30)
 7. Curtis, Martin Luther (b. 1778, d. 1869)
 7. Curtis, Alatheia (b. 1785)
 6. Mallory, Mary (b. 1749-10-17 - Litchfield, Connecticut)

Tracing Ellen's mtDNA

- sp. Curtis, Stephen (b. 1744-01-08 - Woodbury, Litchfield, Connecticut, d. 1813-02-15 - Southbury, New Haven, Connecticut)
 - 7. Curtis, Abner (b. 1772 - Woodbury, Litchfield, Connecticut, d. 1843 - Pennsylvania)
 - 7. Curtis, Amey (b. 1774-02-08 - Woodbury, Litchfield, Connecticut, d. 1849-04-30 - Southbury, New Haven, Connecticut)
 - sp. Tomlinson, William C. (b. 1773-10-27 - New Haven, Connecticut, d. 1819-11-13 - New Haven, Connecticut)
 - 8. Tomlinson, Sarah (b. 1796-10-02 - Southbury, New Haven, Connecticut, d. 1887-01-22 - Southbury, New Haven, Connecticut)
 - sp. Bostwick, Cyrus (b. 1799-03-18 - Southbury, New Haven, Connecticut, d. 1876-03-20 - Southbury, New Haven, Connecticut)
 - 8. Tomlinson, Curtis (b. 1798-02-03)
 - 8. Tomlinson, Clark (b. 1799-05-30)
 - 8. Tomlinson, Harry (b. 1801-03-17)
 - 8. Tomlinson, Stephen (b. 1803-07-29)
 - 8. Tomlinson, Burton (b. 1805-01-01)
 - 8. Tomlinson, Russell (b. 1807-04-05)
 - 8. Tomlinson, Charles (b. 1809-07-06)
 - 8. Tomlinson, Bennet (b. 1811-05-01)
 - 8. Tomlinson, William (b. 1813-02-01)
 - 7. Curtis, Sheldon (b. 1776)
 - 7. Curtis, Mabel (b. 1778)
 - 7. Curtis, Abigail (b. 1780, d. 1855)
 - 7. Curtis, Betsy (b. 1783, d. 1870)
 - 7. Curtis, Stephen (b. 1785-07-13, d. 1838-12-13)
 - 7. Curtis, Charles Ransom (b. 1788-05-07 - Southbury, New Haven, Connecticut, d. 1844-06-02 - Southbury, New Haven, Connecticut)
 - 7. Curtis, Laura (b. 1790-08-07 - New Haven, Connecticut)
 - 7. Curtis, Louisa (b. 1792, d. 1874-04-24)
- 6. Mallory, Freeloove Amy (b. 1752-04-21 - Woodbury, Litchfield, Connecticut, d. 1794 - Oxford, Litchfield, Connecticut)
 - sp. Osborne, Jared (b. 1745-09-24, d. 1832-11-24)
 - 7. Osborne, Gilbert (b. 1782)
 - 7. Osborne, Leverett (b. 1788)
 - 7. Osborne, Ransom (b. 1790)
 - 7. Osborne, Electa (b. 1793)
- 6. Mallory, Edmond (b. 1754)
- 6. Mallory, Lois (b. 1756-03-21)
 - sp. Chatfield, Eli (b. 1754, d. 1840)
 - 7. Chatfield, Mary (b. 1778)
 - 7. Chatfield, Obedience (b. 1782, d. 1836)
 - 7. Chatfield, Lucinda (b. 1784)
 - 7. Chatfield, Lewis (b. 1787, d. 1858)
 - 7. Chatfield, Polly (b. 1788)
 - 7. Chatfield, Sherman (b. 1790, d. 1856)
- 6. Mallory, Azariah (b. 1758, d. 1759)
- 6. Mallory, Daniel (b. 1760-04-27)
- 6. Mallory, Adah (b. 1762-05-08 - Litchfield, Connecticut, d. 1808-08-22)
 - sp. Hitchcock, Caleb (b. 1760-05-17, d. 1826)
 - 7. Hitchcock, Polly (b. 1795)
 - 7. Hitchcock, Harmon (b. 1785, d. 1817)

Tracing Ellen's mtDNA

7. Hitchcock, Caleb (b. 1793)
7. Hitchcock, Huldah (b. 1800-03-26, d. 1875-02-20)
7. Hitchcock, Leusania (b. 1802)
7. Hitchcock, Alvah (b. 1807)
7. Hitchcock, Solomon (b. 1786)
7. Hitchcock, Esther (b. 1789-09-04, d. 1860-05-21)
7. Hitchcock, Adah (b. 1788-05-06, d. 1862-10-25)
7. Hitchcock, Phila (b. 1791-04-17, d. 1869-10-26)
7. Hitchcock, Cyrus (b. 1798, d. 1826)
6. Mallory, Rebecca (b. 1764-02-05 - Litchfield, Connecticut)
6. Mallory, Mabel (b. 1765-11-17 - Litchfield, Connecticut)
6. Mallory, Pene (b. 1767-09-09 - Litchfield, Connecticut)
5. Painter, Amy (b. 1730, d. 1751-09-02)
5. Painter, Thomas (b. 1733, d. 1755)
5. Painter, Abigail (b. 1736, d. 1755-01-26)
5. Painter, Lamberton (b. 1740, d. 1795)
5. Painter, Rebecca (b. 1744, d. 1788-09-18)
5. Painter, Freelove (b. 1749, d. 1751-08-26)
4. Smith, Amy (b. 1709-03-10, d. 1709)
4. Smith, Margaret (b. 1711-06-26, d. 1803-03-27 - Connecticut)
sp. Smith, Austin (b. 1711-04-04 - New Haven, Connecticut, d. 1797-02-08 - Waterbury, Connecticut)
 5. Smith, Margaret (b. 1734-11-05 - New Haven, Connecticut, d. 1821-10-22)
sp. Thompson, Jonathan (b. 1733, d. 1784)
 6. Thompson, Stephen (b. 1759)
 6. Thompson, Esther (b. 1766)
 6. Thompson, Mary (d. 1829)
sp. Hopkins, David (b. 1762, d. 1814)
 7. Hopkins, John
 7. Hopkins, Polly
 7. Hopkins, David
 7. Hopkins, Mabel
 7. Hopkins, Laura
 7. Hopkins, Truman
 7. Hopkins, Edwin
 5. Smith, Mary (b. 1737-02-20 - New Haven, Connecticut, d. 1773-12-07)
 5. Smith, Gad (b. 1740-07-29, d. 1786)
 5. Smith, Austin (b. 1742)
 5. Smith, Hannah (b. 1746)
sp. Hickox, James (b. 1746-11-28 - Waterbury, Connecticut, d. 1833-11-08)
 6. Hickox, Olive (b. 1774-05-07 - Waterbury, Connecticut, d. 1806-12-06 - Naugatuck, New Haven, Connecticut)
sp. Bouton, John (b. 1766 - Fairfield, Connecticut, d. 1840 - Naugatuck, New Haven, Connecticut)
 7. Bouton, Hannah
 7. Bouton, Polly
 7. Bouton, Sally
 7. Bouton, Asa Smith
 7. Bouton, Olive
 7. Bouton, Laura
 7. Bouton, Lowman
 7. Bouton, James

Tracing Ellen's mtDNA

5. Smith, Philena (b. 1750 - Fairfield, Connecticut Colony, d. 1826-11-17 - Chenango County, NY, New York State)
sp. Hickox, Gideon (b. 1752-05-04 - Waterbury, Connecticut, d. 1824-04-25 - Pitcher, New York)
 6. Hickox, David (b. 1772-12-08, bur. 1847-11-08 - Naugatuck, New Haven, Connecticut)
sp. Dutton, Kezia (b. 1783, d. 1865)
 7. Hickox, Caleb Thompson (b. 1817, d. 1895)
 6. Hickox, Sarah (b. 1774-04-15 - Waterbury, Connecticut, d. 1864-07-05 - Taylor, New York)
sp. Beebe, Orillana (b. 1770-03-20, d. 1863-02-25 - Taylor, Cortland, New York)
 7. Beebe, Cokeley/Coakley (b. 1791)
 7. Beebe, Philena (b. 1793-05-06 - Waterbury, Connecticut)
 7. Beebe, Abraham
 7. Beebe, Keziah
 7. Beebe, Mary (b. 1803)
 7. Beebe, Gideon
 7. Beebe, Hannah
 7. Beebe, Orin
 7. Beebe, Lucinda
 7. Beebe, Alonzo
 6. Hickox, Polly (b. 1777-03-04 - Waterbury, Connecticut, d. 1849-09-24 - Pitcher, New York)
sp. Warner, Richard (b. 1772-06-21 - Waterbury, Connecticut, d. 1857-03-25 - Pitcher, New York)
 7. Warner, Obadiah (b. 1793-04-13 - New Haven, Connecticut, d. 1868-11-23 - Naugatuck, New Haven, Connecticut)
sp. Sperry, Lucy L. (b. 1797 - Connecticut, d. 1863-05-04 - New Haven, Connecticut)
 8. Warner, Eliza (b. 1819)
 8. Warner, Clarissa (b. 1821, d. 1849-12-06)
 7. Warner, Sheldon (b. 1794-11-20 - New Haven, Connecticut, d. 1892-02-04 - New York)
sp. , Lucy
 7. Warner, Adna (b. 1796-04-09 - Connecticut, d. 1881 - Connecticut)
sp. Carter, Lucia (b. 1796 - Connecticut, d. 1880 - Connecticut)
 8. Warner, Lucien
 8. Warner, Julia Halbert
 8. Warner, Fredric Addison (b. 1836, d. 1905)
sp. Dodge, Mary M. (b. 1843 - New Hampshire, d. 1903)
 7. Warner, Minerva (b. 1798-01-22)
sp. Fenton, Elijah
 7. Warner, Edward G. (b. 1799-05-14 - New Haven, Connecticut, d. 1890-10-20 - Ohio)
sp. Sales, Sophronia (b. 1806-08-26 - Ohio, d. 1840-03-12)
 8. Warner, Mary Othelia
 8. Warner, Edward C.
 8. Warner, Bellva
 8. Warner, Maria
 8. Warner, Adeline
 8. Warner, Lemira
 8. Warner, Artemissa

Tracing Ellen's mtDNA

- 8. Warner, Calvin E.
- 8. Warner, Joseph V.
- 8. Warner, Sophronia C.
- 7. Warner, Maria (b. 1800-12-03, d. 1895)
sp. Hinman, John
- 7. Warner, David H. (b. 1802-02-02, d. 1896-08-09 - Ohio)
sp. Robbins, Almira (b. 1803-07-26 - New York, d. 1853-07-10 - Ohio)
 - 8. Warner, Elizabeth B.
 - 8. Warner, Adeline
 - 8. Warner, Mary
 - 8. Warner, David S.
 - 8. Warner, Richard
 - 8. Warner, Eliza
- sp. Clayton, Mary (b. 1819)
 - 8. Warner, Florilla
 - 8. Warner, John H.
 - 8. Warner, Lucy
- 7. Warner, Curtis (b. 1802-07-04, d. 1841)
sp. Hyde, Caroline
sp. Robbins, Elizabeth (b. 1813)
 - 8. Warner, Charles Edward (b. 1835-05-31)
 - 8. Warner, John (b. 1837)
 - 8. Warner, Curtis (b. 1841)
 - 8. Warner, Mary (b. 1843)
- 7. Warner, Rachel (b. 1805-07-04, d. 1882)
sp. Pierce, Orlando
- 7. Warner, Electa (b. 1807-07-05 - Parma, Chemung, New York, Chemung,
New York, d. 1863-08-14 - Blooming Valley, Crawford, Pennsylvania)
sp. Robbins, John Edwin Junior (b. 1801-06-01 - Connecticut, d. 1877-03-13 -
Blooming Valley, Crawford, Pennsylvania)
 - 8. Robbins, Louisa Esther (b. 1829-12-02 - Oakland, Livingston, New
York, d. 1922-12-06 - Blooming Valley, Crawford, Pennsylvania)
sp. Hatch, Columbus (b. 1826 - Crawford, Pennsylvania, d. 1904 -
Campbell, South Dakota)
 - 8. Robbins, John Edwin III (b. 1831-03-06 - Oakland, Livingston, New
York, d. 1901-04-09 - Albion PA, Erie, Pennsylvania)
 - 8. Robbins, Sophia Electa (b. 1832-07-29 - Oakland, Livingston, New
York, d. 1871-01-01 - Blooming Valley, Crawford, Pennsylvania)
 - 8. Robbins, Lucia Elila (b. 1834-10-17 - Oakland, Livingston, New York,
d. 1910-10-20 - Canby, Clackamas, Oregon)
sp. Allen, James Henry (b. 1831-11-29 - Brant, NY, Erie County, NY,
New York, d. 1888-11-29 - Mound City, Campbell, South Dakota, US)
 - 8. Robbins, Calvin (b. 1837, d. 1839)
 - 8. Robbins, Mary Elizabeth (b. 1840-01-06 - Crawford, Pennsylvania, d.
1877-05-11 - Crawford, Pennsylvania)
 - 8. Robbins, Mariah (b. 1844-01-02 - Crawford, Pennsylvania, d. 1926-
10-14 - Summit County, OH, Ohio)
 - 8. Robbins, Martha Naomi (b. 1845-07-19 - New York, d. 1936-05-13)
 - 8. Robbins, Helen Josephine (b. 1847-04-14 - Richmond, Pennsylvania,
USA, d. 1883-04-15 - Townville, PA, USA)
sp. Frost, Richard Chambers (b. 1849-05-28 - Erie, Pennsylvania,
USA, d. 1913-02-17 - Cleveland, Ohio, USA)

Tracing Ellen's mtDNA

7. Warner, Lucina (b. 1809-07-05)
sp. Burnham, Norman
7. Warner, Calvin J. (b. 1812-08-00)
sp. Knight, Delia
 8. Warner, Robert (b. 1837)
 8. Warner, Agnes (b. 1844, d. 1897)
 8. Warner, Francis E. (b. 1847)
 8. Warner, Edwin (b. 1851)
 8. Warner, Delia K. (b. 1854)
 8. Warner, Carrie (b. 1859)
 8. Warner, Calvin (b. 1859, d. 1933)
 8. Warner, Bertha (b. 1860)
7. Warner, Florilla (b. 1815-07-06)
7. Warner, Elmina (b. 1817-09-21)
sp. Swan, George P.
7. Warner, Richard P. (b. 1819-04-16 - Pitcher, New York, d. 1920-03-16 - New York)
sp. Debell, Helen (b. 1832, d. 1927)
 8. Warner, Richard Emmons (b. 1862, d. 1936)
 8. Warner, Sheldon P. (b. 1865, d. 1951)
6. Hickox, Hannah Smith (b. 1781-07-02 - New Haven, Connecticut, d. 1856-11-06)
sp. Terrill, Elias (b. 1766-09-20, d. 1835-08-21)
 7. Terrill, Irene
 7. Terrill, Julia Marcia
 7. Terrill, Beulah Smith
 7. Terrill, Susan Hadley
 7. Terrill, Leonora
 7. Terrill, Elias
 7. Terrill, Shelby Wayne
 7. Terrill, Josiah Rice
 7. Terrill, Stephen Dodd
 7. Terrill, Nancy Judson
 7. Terrill, Samuel Newell
 7. Terrill, Eunice Celestia
5. Smith, Anthony (b. 1752, d. 1838-03-03)
5. Smith, Mehitabel (b. 1755-05-28, d. 1834-10-28)
sp. Benham, Elihu (b. 1749-04-26 - New Haven, Connecticut, d. 1836-02-28 - Waterbury, Connecticut)
 6. Benham, Mehitabel (b. 1773)
 6. Benham, Sally (b. 1775)
 6. Benham, Elihu (b. 1777)
 6. Benham, Laurena (b. 1785)
 6. Benham, Ransom (b. 1790, d. 1860)
 6. Benham, Philena (b. 1791)
 6. Benham, Barzll (b. 1795, d. 1878)
 6. Benham, Lewis (b. 1796)
 6. Benham, Desire (b. 1798, d. 1803)
 6. Benham, Leverett (b. 1799, d. 1851)
4. Smith, Thankful (b. 1712-09-30, d. 1769-06-28)
sp. Tolles, Daniel (b. 1705, d. 1782-06-20)
 5. Tolles, Thankful (b. 1737, d. 1820)
sp. Sanford, Daniel (b. 1730, d. 1777)

Tracing Ellen's mtDNA

6. Sanford, Irenah (b. 1753-11-07, d. 1830-09-09 - Litchfield, Connecticut)
sp. Fenn, Samuel (b. 1743 - New Haven, Connecticut, d. 1820 - Litchfield, Connecticut)
 7. Fenn, Irena (b. 1768)
 7. Fenn, Samuel (b. 1770)
 7. Fenn, Eli (b. 1772, d. 1822)
 7. Fenn, Chloe (b. 1774)
 7. Fenn, Thankful (b. 1776, d. 1828)
 7. Fenn, Anna (b. 1778)
6. Sanford, Thankful (b. 1755-11-06, d. 1759)
6. Sanford, Ezekial (b. 1757-11-25, d. 1794-04-04)
6. Sanford, lois (b. 1760-06-15, d. 1832-04-30)
sp. Curtis, Daniel (b. 1754-02-12 - New Haven, Connecticut, d. 1803-03-03 - Litchfield, Connecticut)
 7. Curtis, Polly (b. 1782-09-13 - Litchfield, Connecticut)
 7. Curtis, Eli (b. 1786-09-05)
 7. Curtis, Philena (b. 1779-10-02 - Litchfield, Connecticut)
6. Sanford, Phebe (b. 1762-09-20, d. 1829-01-24 - New York)
sp. Martin, Samuel (b. 1759 - Waterbury, Connecticut)
 7. Martin, Fanny
 7. Martin, Phebe
 7. Martin, Harry
 7. Martin, James
 7. Martin, Daniel
 7. Martin, Samuel
 7. Martin, Peter
 7. Martin, Charlotte
6. Sanford, Eli (b. 1767-02-28 - Waterbury, Connecticut, d. 1827-04-07 - Ohio)
5. Tolles, Nehemiah (b. 1739, d. 1774)
5. Tolles, Daniel (b. 1741)
5. Tolles, Lazarus (b. 1743)
5. Tolles, Dorothy (b. 1745)
5. Tolles, Desire (b. 1745-10-12, d. 1812-06-12)
sp. Beecher, Abraham (b. 1745, d. 1823)
 6. Beecher, Abraham (b. 1771)
 6. Beecher, Philemon
 6. Beecher, Jesse
 6. Beecher, Amos
 6. Beecher, Isaac
 6. Beecher, Eli
 6. Beecher, Frances
 6. Beecher, Lyman
 6. Beecher, Elizabeth
 6. Beecher, Betsy
 6. Beecher, Robert
5. Tolles, Titus (b. 1746)
5. Tolles, Daniel (b. 1748, d. 1829)
5. Tolles, Lamberton (b. 1750, d. 1821)
5. Tolles, Jared (b. 1752, d. 1841)
5. Tolles, Abraham (b. 1754, d. 1793)
5. Tolles, Mary (b. 1756, d. 1842-09-10)
sp. Thomas, Noah (b. 1756, d. 1818-09-06)

Tracing Ellen's mtDNA

- 6. Thomas, Daniel
- 6. Thomas, Aner
- 6. Thomas, Laura
- 6. Thomas, Leveret
- 6. Thomas, Ransom
- 6. Thomas, Charles
- 3. Cooper, Abigail (b. 1679-10-03, d. 1724-12-06)
 - sp. Johnson, Isaac (b. 1672, d. 1750)
 - 4. Johnson, Eunis (b. 1703-05-01, d. 1725-09-05)
 - 4. Johnson, David (b. 1721, d. 1758)
- 3. Cooper, Hannah (b. 1681-08-10, d. 1772-11-11)
 - sp. Lines, John (b. 1676, d. 1709)
 - 4. Lines, Kezia (b. 1715-04-05, d. 1782-01-12)
 - sp. Alling, Samuel (b. 1715, d. 1788)
 - 5. Alling, Ruth (b. 1738-10-08, d. 1777-06-18)
 - sp. Hine, Dan (b. 1734)
 - 6. Hine, Mary (b. 1757)
 - 6. Hine, Kezia (b. 1759)
 - 6. Hine, Rebecca (b. 1760)
 - 6. Hine, Eunice (b. 1760)
 - 6. Hine, Dan (b. 1763)
 - 6. Hine, Elizabeth (b. 1765)
 - 6. Hine, Hannah (b. 1767)
 - 6. Hine, Alexander (b. 1769)
 - 5. Alling, Roger (b. 1741, d. 1824)
 - 5. Alling, Samuel (b. 1743, d. 1810)
 - 5. Alling, Amos (b. 1745, d. 1813)
 - 5. Alling, Kezia (b. 1748-11-26, d. 1765-11-09)
 - 5. Alling, Cornelius (b. 1748, d. 1805)
 - 5. Alling, Eleanor (b. 1751-11-27, d. 1809-10-09)
 - 5. Alling, Hannah (b. 1751-11-27, d. 1821-12-31)
 - 5. Alling, Gideon (b. 1754, d. 1830)
 - 5. Alling, John (b. 1756, d. 1831)
 - sp. Peck, Electa (b. 1761)
 - 3. Cooper, Joseph (b. 1683-09-11 - New Haven, Connecticut, d. 1747)
 - sp. Smith, Abigail
 - 4. Cooper, Phoebe (b. 1707, d. 1750)
 - 4. Cooper, Thankful (b. 1721, d. 1808)
 - 3. Cooper, Rebecca (chr. 1689-08-24, d. 1770-01-02)
 - sp. Alling, Daniel (b. 1688, d. 1756)
 - 4. Alling, Timothy (b. 1712, d. 1772)
 - 4. Alling, Phebe (b. 1723-03-24, d. 1788-04-23)
 - sp. Wolcott, William (b. 1736, d. 1788)
 - 5. Wolcott, Phebe (b. 1755-05-18, d. 1832-07-29)
 - sp. Barney, Hanover (b. 1750, d. 1839)
 - 6. Barney, William (b. 1777, d. 1870)
 - 6. Barney, Silence (b. 1779, d. 1805)
 - 6. Barney, Anna (b. 1781)
 - 6. Barney, Charles (b. 1783)
 - 6. Barney, James (b. 1785)
 - 6. Barney, Susan (b. 1787)
 - 6. Barney, Lebbeus (b. 1790, d. 1795)

Tracing Ellen's mtDNA

- 6. Barney, Phebe (b. 1792)
- 6. Barney, Elizabeth (b. 1794)
- 6. Barney, Mary Ann (b. 1799)
- 5. Wolcott, Willaim (b. 1756-10-03, d. 1782-02-25)
- 5. Wolcott, Eunice (b. 1757, d. 1759)
- 5. Wolcott, Rebecca (b. 1759-08-19, d. 1838-07-26 - New York)
 - sp. Turner, Jabez (b. 1756, d. 1846)
 - 6. Turner, Zina
 - 6. Turner, Timothy
 - 6. Turner, Jerusha
 - 6. Turner, Beuajah (b. 1779, d. 1872)
 - 6. Turner, William
 - 6. Turner, Bela (b. 1788, d. 1879)
- 5. Wolcott, Benajah (b. 1762-04-07, d. 1832-08-11 - Ohio)
- 5. Wolcott, Timothy (b. 1763, d. 1767-09-02 - New Haven, Connecticut)
- 4. Alling, Silas (b. 1734-09-11, d. 1817)
- 2. Thompson, Hannah (b. 1643, d. 1681)
 - sp. Moulthrop, Matthew (b. 1638, d. 1691)
 - 3. Moulthrop, Hannah (b. 1663-11-02)
 - 3. Moulthrop, Hannah (b. 1665-04-20, d. 1713-01-30)
 - sp. Russell, John (b. 1664-12-14, d. 1724-02-13)
 - 4. Russell, Hannah (b. 1689-02-17, d. 1751)
 - sp. Gregory, Joseph (b. 1674-07-16)
 - 5. Gregory, John (b. 1710)
 - 5. Gregory, Joseph (b. 1716)
 - 5. Gregory, Josiah (b. 1720)
 - 5. Gregory, Daniel (b. 1722)
 - 5. Gregory, Russell (b. 1724, d. 1777)
 - 4. Russell, Lydia (b. 1692-09-18, d. 1750)
 - sp. Utter, Abraham (b. 1688, d. 1761)
 - 5. Utter, Abraham (b. 1716, d. 1779)
 - 5. Utter, Lydia (b. 1718-11-24, d. 1750-08-21)
 - sp. Welton, Thomas (b. 1710, d. 1780)
 - 5. Utter, Samuel (b. 1720)
 - 5. Utter, John (b. 1722)
 - 5. Utter, Isaac (b. 1724)
 - 5. Utter, Mary (b. 1727-11-24, d. 1728)
 - 5. Utter, Sarah (b. 1730-07-03, d. 1731)
 - 5. Utter, Jabez (b. 1733)
- 4. Russell, John (b. 1695, d. 1774)
- 4. Russell, Edward (b. 1698-04-19, d. 1773-04-21)
 - sp. Utter, Katherine
 - 5. Russell, Benjamin (b. 1735-02-02)
 - sp. Utter, Mary (b. 1737)
- 4. Russell, Abigail (b. 1701-05-19)
 - sp. Hodges, Abraham (b. 1697)
 - 5. Hodges, Isaac (b. 1729)
 - 5. Hodges, Abraham (b. 1726)
 - 5. Hodges, Abigail (b. 1731-04-13)
 - 5. Hodges, David (b. 1733)
 - 5. Hodges, Samuel (b. 1736)
- 4. Russell, Rachel (b. 1703-12-15, d.)

Tracing Ellen's mtDNA

- sp. Brewster, William (b. 1695, d. 1764)
 - 5. Brewster, Samuel (b. 1738)
 - 5. Brewster, Pelatiah (b. 1741, d. 1806)
 - 5. Brewster, John (b. 1746)
- 4. Russell, Mabel (b. 1706-07-14, d. 1782-04-20)
 - sp. Utter, Benjamin (b. 1709-11-24)
 - 5. Utter, Mary (b. 1737)
 - sp. Russell, Benjamin (b. 1735-02-02)
 - 5. Utter, Mabel (b. 1765)
- 4. Russell, Sarah (b. 1711-02-23, d. 1761-01-01 - East haven, New Haven, Connecticut)
 - sp. Shepard, John (b. 1696-08-09 - Bristol, Rhode Island, d. 1780-05-18 - East haven, New Haven, Connecticut)
 - 5. Shepard, Sarah (b. 1728-03-11 - East haven, New Haven, Connecticut, d. 1783-06-01 - East haven, New Haven, Connecticut)
 - sp. Chidsey, John (b. 1720-09-15 - East haven, New Haven, Connecticut, d. 1783-09-17 - East haven, New Haven, Connecticut)
 - 6. Chidsey, Hannah (b. 1747-05-06, d. 1840-09-07)
 - 6. Chidsey, John (b. 1749-12-16, d. 1816-05-06)
 - 6. Chidsey, Ephraim (b. 1752-03-19, d. 1832-09-26)
 - 6. Chidsey, Roswell (b. 1754-07-17, d. 1795-02-01)
 - 6. Chidsey, Street (b. 1756-11-15, d. 1777-04-20)
 - 6. Chidsey, Sarah (b. 1758-10-20 - East haven, New Haven, Connecticut)
 - 6. Chidsey, Simon (b. 1762-03-03)
 - 6. Chidsey, Rhoda (b. 1764-07-21 - East haven, New Haven, Connecticut, d. 1820-03-26 - Canonsville, Delaware, New York)
 - 6. Chidsey, Mary (b. 1765-09-26 - East haven, New Haven, Connecticut)
 - sp. Curtis, Phineas (b. 1765, d. 1806)
 - 7. Curtis, Polly (b. 1788, d. 1836)
 - 7. Curtis, Hannah (b. 1790, d. 1848)
 - 7. Curtis, Russell (b. 1792)
 - 7. Curtis, Lowly (b. 1794)
 - 7. Curtis, Asenath (b. 1796)
 - 7. Curtis, Benjamin (b. 1798)
 - 7. Curtis, Major (b. 1800)
 - 7. Curtis, John (b. 1802, d. 1834)
 - 7. Curtis, Susan (b. 1804)
 - 7. Curtis, Street (b. 1806, d. 1808)
 - 6. Chidsey, Eunice (b. 1768-05-01 - East haven, New Haven, Connecticut)
 - sp. Walker, William (b. 1766-02-06 - East haven, New Haven, Connecticut)
 - 7. Walker, John (b. 1788)
 - 7. Walker, William (b. 1790)
 - 7. Walker, James (b. 1792)
 - 6. Chidsey, Samuel (b. 1770-10-08 - East haven, New Haven, Connecticut, d. 1771-04-10 - East haven, New Haven, Connecticut)
 - 6. Chidsey, Ezekiel (b. 1770-10-08, d. 1850-01-27)
 - 5. Shepard, Mary (b. 1731-09-13, d. 1743-09-28)
 - 5. Shepard, Elizabeth (b. 1734-07-20 - East haven, New Haven, Connecticut, d. 1819-02-21 - Windham, Vermont)
 - sp. Hotchkiss, Enos (b. 1731-05-13, d. 1806-10-27)
 - 6. Hotchkiss, Huldah (d. 1851)
 - 6. Hotchkiss, Elihu (b. 1756, d. 1840)
 - 6. Hotchkiss, Enoch (b. 1763, d. 1836)

Tracing Ellen's mtDNA

6. Hotchkiss, Stephen (b. 1772, d. 1851)
5. Shepard, John (b. 1736, d. 1743)
5. Shepard, Stephen (b. 1740, d. 1819)
5. Shepard, John (b. 1743, d. 1811)
5. Shepard, Mary (b. 1746-09-30, d. 1838-02-09 - East haven, New Haven, Connecticut)
 - sp. Grannis, David (b. 1744, d. 1785-05-17 - East haven, New Haven, Connecticut)
 6. Grannis, Mary (b. 1764)
 - sp. Eaton, Giles (b. 1756)
 7. Eaton, Mary
 6. Grannis, Huldah (b. 1766)
 - sp. Barnes, Levi (b. 1762)
 7. Barnes, Levi (b. 1792)
 7. Barnes, Nancy (b. 1798)
 7. Barnes, Asenath (b. 1794)
 7. Barnes, Lydia (b. 1796)
 6. Grannis, Lydia (b. 1769, d. 1770)
 6. Grannis, Lydia (b. 1771, d. 1856-12-11)
 - sp. Bradley, Amma (b. 1769-11-21, d. 1832-08-24)
 7. Bradley, James (b. 1795, d. 1796)
 7. Bradley, Nancy (b. 1797)
 7. Bradley, James (b. 1801, d. 1813)
 7. Bradley, Almira (b. 1803)
 6. Grannis, Sarah (b. 1773)
 - sp. Webster, Elihu (b. 1769)
 6. Grannis, Mabel (b. 1775)
 6. Grannis, Asenath (b. 1779, d. 1848-11-18)
 - sp. Bradley, Asahel (b. 1778, d. 1861)
 7. Bradley, Betsy
 7. Bradley, Asenath
 7. Bradley, Eben
 7. Bradley, Joseph
 7. Bradley, Mary
 7. Bradley, Jared
 7. Bradley, Asahel
 7. Bradley, Lydia
 7. Bradley, Jared Eben
 7. Bradley, Lydia
 6. Grannis, Elizabeth (b. 1781)
 - sp. Barrow, Francis (b. 1787, d. 1853)
 7. Barrow, Henry
 7. Barrow, Typhena
 7. Barrow, George F.
 7. Barrow, Eliza A.
 7. Barrow, Edwin S.
 7. Barrow, Mary G.
 7. Barrow, Clarissa M.
 6. Grannis, David (b. 1784, d. 1803 - East haven, New Haven, Connecticut)
 5. Shepard, Levi (b. 1753)
 5. Shepard, Huldah (b. 1755-11-25 - East haven, New Haven, Connecticut)
 - sp. Townsend, Elias (b. 1754-03-25)
 6. Townsend, Huldah (b. 1782)
 6. Townsend, Elias (b. 1779)

Tracing Ellen's mtDNA

6. Townsend, Elizabeth (b. 1784)
6. Townsend, Nancy (b. 1788)
3. Moulthrop, John (b. 1667-02-05)
3. Moulthrop, Matthew (b. 1670-07-18)
3. Moulthrop, unknown (b. 1673)
3. Moulthrop, Lydia (b. 1674-08-08, d. 1677-10-14)
3. Moulthrop, Samuel (b. 1677-06-24, d. 1677-10-14)
3. Moulthrop, Samuel (b. 1679-04-13)
3. Moulthrop, Kezia (b. 1682-04-13, d. 1767-12-31)
 - sp. Barker, Daniel (b. 1676-01-27, d. 1752-01-25)
 4. Barker, Joseph (b. 1702, d. 1746)
 4. Barker, Daniel (b. 1705, d. 1801)
 4. Barker, Hannah (b. 1707-11-15, d. 1785-07-18)
 - sp. Rose, David (b. 1700-12-06, d. 1785-09-19)
 5. Rose, Keziah (b. 1730-02-25, d. 1754-09-08)
 - sp. Hudson, David
 6. Hudson, David (b. 1754, d. 1755-01-14)
 5. Rose, David (b. 1736, d. 1799)
 5. Rose, Simeon (b. 1747, d. 1776)
 5. Rose, Levi (b. 1751, d. 1831)
 4. Barker, Edward (b. 1708, d. 1763)
 4. Barker, Kezia (b. 1710-04-03, d. 1793-06-05)
 - sp. Smith, Dow (b. 1704)
 5. Smith, Isaac (b. 1743)
 5. Smith, Dow (b. 1745)
 5. Smith, Daniel (b. 1748)
 5. Smith, Jordan (b. 1733)
 4. Barker, Lydia (b. 1712-12-22, d. 1781-04-13)
 - sp. Palmer, Stephen H. (b. 1708, d. 1782-04-06)
 5. Palmer, Stephen (b. 1735)
 5. Palmer, Phebe (b. 1738-03-03, d. 1788)
 - sp. Foote, Ebenezer (b. 1734)
 6. Foote, Thankful (b. 1759-09-24)
 - sp. Smith, Isaac (b. 1755)
 6. Foote, Lucretia (bap. 1775-09-24)
 - sp. Butler, James (b. 1761)
 5. Palmer, Ebenezer (b. 1743)
 5. Palmer, Asahel (b. 1747)
 5. Palmer, Esther (b. 1751-11-27)
 4. Barker, Samuel (b. 1715, d. 1781)
 4. Barker, Thankful (b. 1719-04-19, d. 1791-10-26)
 - sp. Rose, Nathan (b. 1705, d. 1789)
 5. Rose, Sarah (b. 1748-04-24, d. 1821-01-10)
 - sp. Whedon, Solomon (b. 1749, d. 1814-12-12)
 6. Whedon, Lucretia (b. 1782, d. 1807)
 5. Rose, Joseph (d. 1776)
 5. Rose, Nathan (d. 1844)
 4. Barker, Timothy (b. 1723, d. 1779)
 2. Thompson, Ebenezer (b. 1648-10-15, d. 1674)
 2. Thompson, Joseph (b. 1649, d. 1703)
 - sp. Lathrop, Elizabeth
 2. Thompson, Abigail (b. 1651-01-26, d. 1727)

Tracing Ellen's mtDNA

- sp. Alsop, Joseph (b. 1649, d. 1691-01-12)
- 2. Thompson, Rebecca (b. 1651-01-26 - New Haven, Connecticut, d. 1716 - New Haven, Connecticut)
 - sp. Thomas, Daniel (b. 1647, d. 1694)
 - 3. Thomas, Thomas (b. 1670, d. 1670)
 - 3. Thomas, John (b. 1672, d. 1711-01-25)
 - 3. Thomas, Dorothy (b. 1674, d. 1727-10-19)
 - sp. Tolles, Henry (b. 1669-11-01, d. 1750)
 - 4. Tolles, Experience (b. 1694, d. 1737)
 - sp. Osborne, Joseph (b. 1694-02-18, d. 1724)
 - 5. Osborne, Daniel (b. 1715, d. 1791)
 - 5. Osborne, Joseph (b. 1718, d. 1797)
 - sp. Mallory, Esther (b. 1718-06-18, d. 1769-03-21)
 - 6. Osborne, Jared (b. 1745-09-24, d. 1832-11-24)
 - sp. Mallory, Freelove Amy (b. 1752-04-21 - Woodbury, Litchfield, Connecticut, d. 1794 - Oxford, Litchfield, Connecticut)
 - 7. Osborne, Gilbert (b. 1782)
 - 7. Osborne, Leverett (b. 1788)
 - 7. Osborne, Ransom (b. 1790)
 - 7. Osborne, Electa (b. 1793)
 - 5. Osborne, Amos (b. 1722, d. 1807)
 - 5. Osborne, Esther (b. 1721, d. 1815-03-21)
 - sp. Booth, Stephen (b. 1721, d. 1769-11-04)
 - 6. Booth, George (b. 1737, d. 1813)
 - 6. Booth, Stephen (b. 1751, d. 1815)
 - 6. Booth, Elizabeth (b. 1753-10-11, d.)
 - 4. Tolles, Rachael (b. 1702, d. 1746)
 - sp. Ruggles, Joseph (b. 1701-01-30, d. 1791 - Brookfield, Fairfield, Connecticut Colony)
 - 5. Ruggles, Lois (b. 1727, d. 1781)
 - 5. Ruggles, Joseph (b. 1728, d. 1802)
 - 5. Ruggles, Lazarus (b. 1730, d. 1797)
 - 5. Ruggles, Rachel (b. 1732, d. 1800)
 - 5. Ruggles, Mercy (b. 1732, d. 1822)
 - 5. Ruggles, Mabel (b. 1736, d. 1804)
 - 5. Ruggles, Ashbel (b. 1739, d. 1814)
 - 4. Tolles, Daniel (b. 1705, d. 1782-06-20)
 - sp. Smith, Thankful (b. 1712-09-30, d. 1769-06-28)
 - 5. Tolles, Thankful (b. 1737, d. 1820)
 - sp. Sanford, Daniel (b. 1730, d. 1777)
 - 6. Sanford, Irenah (b. 1753-11-07, d. 1830-09-09 - Litchfield, Connecticut)
 - sp. Fenn, Samuel (b. 1743 - New Haven, Connecticut, d. 1820 - Litchfield, Connecticut)
 - 7. Fenn, Irena (b. 1768)
 - 7. Fenn, Samuel (b. 1770)
 - 7. Fenn, Eli (b. 1772, d. 1822)
 - 7. Fenn, Chloe (b. 1774)
 - 7. Fenn, Thankful (b. 1776, d. 1828)
 - 7. Fenn, Anna (b. 1778)
 - 6. Sanford, Thankful (b. 1755-11-06, d. 1759)
 - 6. Sanford, Ezekial (b. 1757-11-25, d. 1794-04-04)
 - 6. Sanford, lois (b. 1760-06-15, d. 1832-04-30)
 - sp. Curtis, Daniel (b. 1754-02-12 - New Haven, Connecticut, d. 1803-03-03 - Litchfield, Connecticut)

Tracing Ellen's mtDNA

7. Curtis, Polly (b. 1782-09-13 - Litchfield, Connecticut)
7. Curtis, Eli (b. 1786-09-05)
7. Curtis, Philena (b. 1779-10-02 - Litchfield, Connecticut)
6. Sanford, Phebe (b. 1762-09-20, d. 1829-01-24 - New York)
sp. Martin, Samuel (b. 1759 - Waterbury, Connecticut)
 7. Martin, Fanny
 7. Martin, Phebe
 7. Martin, Harry
 7. Martin, James
 7. Martin, Daniel
 7. Martin, Samuel
 7. Martin, Peter
 7. Martin, Charlotte
6. Sanford, Eli (b. 1767-02-28 - Waterbury, Connecticut, d. 1827-04-07 - Ohio)
5. Tolles, Nehemiah (b. 1739, d. 1774)
5. Tolles, Daniel (b. 1741)
5. Tolles, Lazarus (b. 1743)
5. Tolles, Dorothy (b. 1745)
5. Tolles, Desire (b. 1745-10-12, d. 1812-06-12)
sp. Beecher, Abraham (b. 1745, d. 1823)
 6. Beecher, Abraham (b. 1771)
 6. Beecher, Philemon
 6. Beecher, Jesse
 6. Beecher, Amos
 6. Beecher, Isaac
 6. Beecher, Eli
 6. Beecher, Frances
 6. Beecher, Lyman
 6. Beecher, Elizabeth
 6. Beecher, Betsy
 6. Beecher, Robert
5. Tolles, Titus (b. 1746)
5. Tolles, Daniel (b. 1748, d. 1829)
5. Tolles, Lamberton (b. 1750, d. 1821)
5. Tolles, Jared (b. 1752, d. 1841)
5. Tolles, Abraham (b. 1754, d. 1793)
5. Tolles, Mary (b. 1756, d. 1842-09-10)
sp. Thomas, Noah (b. 1756, d. 1818-09-06)
 6. Thomas, Daniel
 6. Thomas, Aner
 6. Thomas, Laura
 6. Thomas, Leveret
 6. Thomas, Ransom
 6. Thomas, Charles
4. Tolles, Henry (b. 1705)
4. Tolles, Dorothy (b. 1711, d. 1785-08-14)
sp. Bristol, Stephen (b. 1707, d. 1785)
 5. Bristol, Stephen (b. 1734, d. 1789)
 5. Bristol, Ichabod (b. 1736)
 5. Bristol, Abner (b. 1738, d. 1790)
 5. Bristol, Rachel (b. 1739-12-11 - New Haven, Connecticut, d. 1817-05-06 - New Haven, Connecticut)

Tracing Ellen's mtDNA

5. Bristol, David (b. 1742, d. 1790)
5. Bristol, Dorothy (b. 1748 - New Haven, Connecticut, d. 1834-08-12 - New Haven, Connecticut)
5. Bristol, Dinah (b. 1751 - New Haven, Connecticut, d. 1785-06-17 - New Haven, Connecticut)
4. Tolles, Samuel (b. 1715, d. 1756)
4. Tolles, Ebenezer (b. 1728, d. 1754)
4. Tolles, Mary (b. 1730, d. 1731)
3. Thomas, Daniel (b. 1676-02-14, d. 1760)
3. Thomas, Dinah (b. 1678-12-26, d. 1769)
- sp. Sherman, John (b. 1673, d. 1727)
 4. Sherman, Lydia (b. 1699-12-20, d. 1733-09-17 - New Haven, Connecticut)
 - sp. Todd, James (b. 1696, d. 1779)
 5. Todd, Ebenezer (b. 1722, d. 1798)
 5. Todd, James (b. 1725, d. 1806)
 5. Todd, Lydia (b. 1727-07-06 - New Haven, Connecticut, d. 1819-09-14)
 - sp. Smith, James (b. 1713, d. 1805)
 6. Smith, Mary (b. 1747, d. 1796)
 6. Smith, James (b. 1750, d. 1809)
 6. Smith, Benjamin (b. 1753, d. 1774)
 6. Smith, John (b. 1756, d. 1847)
 6. Smith, Thomas (b. 1761, d. 1815)
 6. Smith, Eli (b. 1764, d. 1845)
 6. Smith, Mabel (b. 1769-01-20, d. 1842)
 - sp. Munson, Merriman (d. 1818)
 7. Munson, Ira (b. 1792, d. 1841)
 7. Munson, Roswell (b. 1798, d. 1860)
 7. Munson, Mary (b. 1804-12-08, d. 1889-07-04)
5. Todd, Lois (b. 1729-11-10 - New Haven, Connecticut, d. 1812-09-27 - New Haven, Connecticut)
 - sp. Turner, James (b. 1727, d. 1788)
 6. Turner, Lois (b. 1748-10-12 - New Haven, Connecticut, d. 1776-10-31 - New Haven, Connecticut)
 6. Turner, Bethuel (b. 1751)
 6. Turner, Mary (b. 1754-04-17 - New Haven, Connecticut, d. 1829-01-05 - New Haven, Connecticut)
 6. Turner, Dorcas (b. 1756-09-30 - New Haven, Connecticut, d. 1831-01-13 - New Haven, Connecticut)
 6. Turner, Bethuel (b. 1761)
5. Todd, Eunice (b. 1732-06-10 - New Haven, Connecticut, d. 1823 - New Haven, Connecticut)
 - sp. Gilbert, John (b. 1731-11-09)
 6. Gilbert, Sarah (b. 1758-08-26 - New Haven, Connecticut)
 6. Gilbert, Eunice (b. 1762-02-20, d. 1835)
 - sp. Tuttle, Jesse (b. 1759, d. 1848)
 6. Gilbert, John (b. 1764, d. 1774)
 6. Gilbert, Mabel (bap. 1767-05-10)
 - sp. Munson, Ezra (b. 1757, d. 1800)
 6. Gilbert, Lydia (bap. 1769-01-29 - New Haven, Connecticut, d. 1774-10-02 - New Haven, Connecticut)
 6. Gilbert, Julius (b. 1771)
4. Sherman, Dinah (b. 1702-10-27, d. 1739-12-19 - New Haven, Connecticut)

Tracing Ellen's mtDNA

- sp. Atwater, James (b. 1698, d. 1766)
 - 5. Atwater, James (b. 1724)
 - 5. Atwater, Abigail (b. 1727-11-19)
 - sp. Peck, Nicholas (b. 1732, d. 1793)
 - 6. Peck, Abigail (b. 1754-12-13, d. 1787-06-03 - New York)
 - 6. Peck, Mary (bap. 1758-08-27)
 - 6. Peck, Pamela (b. 1761-01-25)
 - 6. Peck, William (b. 1763, d. 1782)
 - 6. Peck, Elijah (b. 1765)
 - 6. Peck, Mary Dinah (b. 1767-10-31)
 - 6. Peck, Sarah (b. 1770-03-10, d. 1770)
 - 5. Atwater, Elijah (b. 1730, d. 1732)
 - 5. Atwater, Elijah (b. 1732)
 - 5. Atwater, Lydia (b. 1734-08-25, d. 1748-01-19)
 - 5. Atwater, Rachel (b. 1737-04-26, d. 1809-10-11)
 - sp. Bradley, Jonah (b. 1732, d. 1814)
 - 6. Bradley, Betsy M. (d. 1892)
 - 6. Bradley, Sarah (b. 1774, d. 1845)
- 4. Sherman, Samuel (b. 1704-02-01, d. 1769)
- 4. Sherman, Elizabeth (b. 1708-01-25, d. 1738-09-17 - New Haven, Connecticut)
 - sp. Gilbert, Stephen (b. 1708, d. 1754)
 - 5. Gilbert, Stephen (b. 1732, d. 1738)
 - 5. Gilbert, Moses (b. 1735)
 - 5. Gilbert, Sarah (b. 1730-04-10, d. 1798)
 - sp. Potter, David (b. 1717-11-26, d. 1773-11-26)
 - 6. Potter, Abel (b. 1749, d. 1818)
 - 6. Potter, David (b. 1751, d. 1761)
 - 6. Potter, Samuel (b. 1759, d. 1779)
 - 6. Potter, Elizabeth (b. 1754, d. 1817-01-06 - New Haven, Connecticut)
 - sp. Ford, Stephen (b. 1749, d. 1843)
 - 7. Ford, Anna (b. 1778, d. 1826)
 - 7. Ford, Stephen (b. 1776, d. 1815)
 - 7. Ford, Nathaniel (b. 1781, d. 1794)
 - 7. Ford, Elizabeth (b. 1783)
 - 7. Ford, Rachel (b. 1786, d. 1854-11-25)
 - 7. Ford, Lyman (b. 1789, d. 1859)
 - 6. Potter, Sarah (b. 1756, d. 1790-05-27)
 - 5. Gilbert, Abel (b. 1737, d. 1738)
 - 3. Thomas, Samuel (b. 1680-01-13, d. 1681)
 - 3. Thomas, Recompence (b. 1683-05-27, d. 1703-08-31)
 - 3. Thomas, Israel (b. 1685, d. 1767)
 - 3. Thomas, Experience (b. 1687-04-17, d. 1703-08-31 - New Haven, Connecticut)
 - 2. Thompson, Sarah (b. 1654-04-30, d. 1716-10-23 - New Haven, Connecticut)
 - sp. Ball, Alling (b. 1656, d. 1710)
 - 3. Ball, Lydia (b. 1680-01-02, d. 1738-03-06)
 - sp. Hemmingway, Jacob (b. 1683-12-06, d. 1754-10-06)
 - 4. Hemmingway, Lydia (b. 1716-09-02 - East haven, New Haven, Connecticut, d. 1779-05-27 - Clinton, Middlesex, Connecticut)
 - sp. Pierpoint, Hezehiah (b. 1712, d. 1741)
 - 5. Pierpoint, John (b. 1740, d. 1806)
 - sp. Morgan, Theophilus (b. 1703, d. 1766)
 - 5. Morgan, William (b. 1746, d. 1806 - Clinton, Middlesex, Connecticut)

Tracing Ellen's mtDNA

- 5. Morgan, Mary (b. 1751-05-07, d. 1768-01-20 - Clinton, Middlesex, Connecticut)
- 5. Morgan, Theophilus (b. 1755, d. 1844)
- 3. Ball, Allen (b. 1689, d. 1761)
- sp. Harrison, Thomas (b. 1627 - England, d. 1704)
- 2. Harrison, Thomas (b. 1657, d. 1757)
- 2. Harrison, Nathaniel (b. 1658)