

0-General Introduction	3
1.0-Loy-Allen Family	7
1.1-LifeAndTimesOfJohannLay	11
1.2-meadville-migration	79
2-Ahnentafel (Ancestor) Reports	109
3-Family Group Chart	115
4-Fan (pedigree)	117
5.0-Snyder Family Research	119
5.1-CaseForCatherine	125
5.2-ChristianSelanderSr-children	135
5.3-JohnSnyder-Clues	181
5.4-SimonCulp-EllenSelanders	275
6.0-Tracing mtDNA	327
6.1-TracingEllensmtDNA	331



**281Connections:**  
**The Family History Work**  
of  
**Craig Rhombs**

*South Dakota Roots: Loy/Allen Ancestors*

# 281Connections

First published in 2023

Plymouth, MN

by Craig Rhombs  
[craig@281connections.us](mailto:craig@281connections.us)

This work is available under the Creative Commons cc by-SA license



<https://creativecommons.org/licenses/by-sa/4.0/>

# 281Connections

## Foreword

This is a snapshot of the results of my family history research. Organizationally it is based on my website at <https://281connections.us> as it exists at revision 36. As explained there, it starts with eight pairs of great grandparents for my wife and myself and works backward in time. There are seven volumes, which are listed below. The most up to date version of the material will always be the website.

### Volumes:

- General Introduction
- South Dakota Roots: Bates/Moodie Ancestors
- **South Dakota Roots: Loy/Allen Ancestors ←This volume**
- South Dakota Roots: Rhombs/Kessler Ancestors
- South Dakota Roots: Thompson/Olsen Ancestors
- South Dakota Roots: Memorials and Mysteries
- Texas Roots: Kosub/Kokott, Long/Gill, Marsch/Fincke, Mihalski/Kosub

In many ways this is a record of one of the ways in which I have spent 9+ years of my retirement. I certainly owe thanks to many people, most of whom are mentioned in the volumes that follow. Any mistakes are mine, and I hope to be corrected.

## 281Connections

### **South Dakota Roots: Loy/Allen Ancestors**

- Introduction of the Loy-Allen Family
- Ahnentafel Reports
- Family Group Report
- Fan Chart
- Sources of Information about Sam and Anna (Allen) Loy
- Information about Johann Georg Lay
- A Description of the Migration of Families to South Dakota
- A Report on a Trip to Southern Wisconsin
- A Report on Research into the Snyder Family of Waldo, OH
  - The Case for Catharine Culp
  - Selanders Family Research
  - Research into John Snyder's Ancestors
  - Culp Family Research
- Tracing mtDNA
  - Ellen's Descendants – Report



## 281connections Wiki

**About**

**Copyright(left)**

**Education**

**Privacy**

**South Dakota Families**

**Bates-Moodie**

**Loy-Allen**

**Ahnentafel**

**AncestralCollapsible**

**FamilyGroup**

**Fan**

**Snyder Family Research**

**Tracing mtDNA**

**Memorials**

**Mysteries**

**Rombs-Kessler**

**Thompson-Olsen**

**Texas Families**



## Loy-Allen Family



**Anna Allen, c.1939-1940**



**Sam Loy, c.1905**

Formation of the family of Sam Loy and Anna Allen represents an improbable convergence of people hoping for better opportunities in the vicinity of Mound City, SD.

The Allen family that Anna was a part of came from the area around Blooming Valley, PA. Her maternal ancestors can be traced to colonial Connecticut by way of NY and PA. Her paternal ancestors trace back to Fabius, NY, but from there backward in time there is uncertainty. (See one of the "[Mysteries](#)" entries.) Anna seems to have been a kind soul as viewed by her grandchildren. And she was a good shot!

Sam's path to South Dakota was probably somewhat rocky and included a prior marriage to a lady (Margaret Rower) in Ohio which produced a son named William H. Loy, who became an undertaker in Auburn, IN. Sam's predecessors were Germanic in origin. His father emigrated in 1853 from near Pforzheim in Baden to near Prospect, Ohio, just after the 1848 Revolution in the German states. His mother was from a family that moved to near Waldo, OH, from PA in the middle of the 19th century. In 1860, Sam's father (John) and mother (Susannah) headed a family of 6 people, including a one year old Sam and siblings from John's former marriage to Sophia (Kaelber) Heidegger as well as the current marriage. Susannah may have died (or left the family) when Sam was fairly young, and his father relocated a little farther west in OH (Van Wert & Allen Counties) . It also appears that he married twice more, and he had cousins from the Baden area living in Crawford Co., OH. I have created a separate [document](#) to describe in some detail what is known about Sam's father, Johann Georg Lay, a.k.a. John Loy, in locations ranging from Göbrichen in Baden to Delphos, OH.

Tracing Susannah's family has been very challenging. Her parents (John and Catherine Snyder) were from PA and moved to OH in about 1833. They probably are the descendants of people who emigrated from the Rhein Palatinate to Pennsylvania. The details of their lives have largely eluded me, but you can read what I have found in a [section](#) devoted just to this topic.

The family group sheet for Sam and Anna is [here](#). Ahnentafel reports for each can be found [here](#). A fan chart centered on one of their children is [here](#). A more traditional interactive pedigree chart centered on one of their children is [here](#).

In the course of researching this family, I have assembled additional documentation, including source descriptions and photos. For example, there is an [analysis](#) of the locations of related families that relocated to Campbell Co., SD, late in the 19th century. I have also investigated the maternal (mtDNA) line that Anna represents. The analysis is in an accompanying section entitled "[Tracing Ellen's mtDNA](#)". Ellen is the likely name of the first person in this line to settle in the New Haven area of Colonial Connecticut around 1640. A general document providing some detailed source information is [here](#).

Locations of Sam and Anna's families in the latter part of the 19th century are shown approximately in the period map that follows. The picture that follows shows the family probably sometime around 1910.



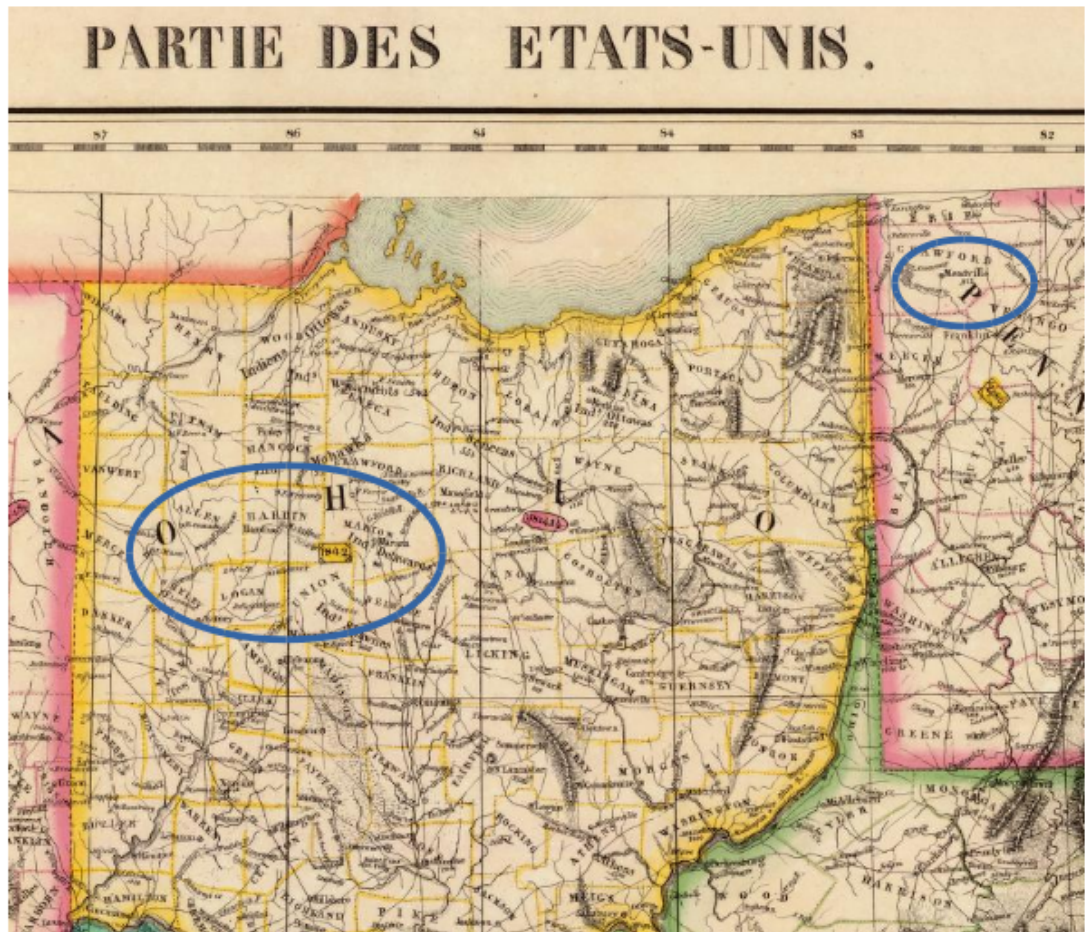

Above: Approx. locations of Sam (western blue oval) and Anna (eastern blue oval) before moving to South Dakota in the late 19th century.



Above: The Loy/Allen family - c. 1911 - in South Dakota.

**Backlinks:**

[281connections Wiki](#)

[281connections Wiki:About](#)

[281connections Wiki:South Dakota Families](#)

[281connections Wiki:South Dakota Families:Loy-Allen:Tracing mtDNA](#)

Created with [Zim-wiki](#) & the [Ecodiv-responsive template](#)

# Johann Georg Lay a.k.a. John Loy

## Table of Contents

Introduction.....	3
Revision Record.....	3
Birth Family.....	5
Deeper Ancestry.....	10
Early Marriages.....	13
John's Marriage to Christina Lay.....	13
First Child (with Christina Lay).....	14
John's Marriage to Sophia Kaelber.....	15
Children with Sophia: Katharina (9/26/1851) and Johann Georg (12/29/1848) and Mary (9/26/1853).....	16
Birth of Johann Georg Lay (i.e., John in the 1860 US census) on 12/29/1848 in Würm.....	16
Birth of Katharina (i.e., Catherine in the 1860 US Census) on 9/26/1851 also in Würm.....	17
Birth of Mary in OH on 9/26/1853.....	18
Family Group Chart.....	20
Sophia Kaelber and Her First Marriage.....	21
Birth and Death.....	21
Sophia's First Marriage.....	24
unnamed child (b.1844, d.1844).....	25
Sophia Heidegger (b.4/9/1845).....	26
Friedrich Heidegger (b.1845, d.1846).....	27
Wilhelm Martin Heidegger (b. 11/12/1846).....	28
Evidence for Emigration of Children.....	29
Wilhelm/William in 1860.....	29
Wilhelm's Burial in 1928.....	30
Sophia in 1860.....	31
Sophia Seibert's Death.....	31
Sophia Seibert's Burial.....	32
Emigration, Immigration, and Naturalization.....	34
Emigration.....	34
Immigration.....	34
Naturalization.....	36
Marriage (to Susannah Snyder).....	38
An Aside about Susannah's Birth Family.....	41
Activities From Mid-1860s Until Death.....	43
Marriage to Mariah Augustine.....	43
Subsequent Marriage to Catherine Klinger Louth.....	45
The 1870 Federal Census.....	51
The 1880 Federal Census.....	57
Death.....	60

# Johann Georg Lay a.k.a. John Loy

Families of children.....	61
Summary.....	63
Future Research.....	66

# Johann Georg Lay a.k.a. John Loy

## Introduction

Sam Loy (b.1859 in OH) is a great grandfather of mine. His father, John Loy, came to the USA (OH) in 1853 from Baden. John already had a family, but it appears that his wife, Sophia, did not survive long after arrival. John remarried in the late 1850s to a lady named Susannah Snyder, whose family originated in PA. Susannah is Sam's mother.

This is an attempt to weave a story, consistent with known facts, to explain events associated with the families of John Loy. Along the way I will also explain some potentially confusing or not currently understood facts and some apparent transcription errors.

My goal is to provide a framework that can be built on and revised to arrive at the most accurate history possible, given the nature of the known facts. Future research is also suggested.

Others have written documents that have been helpful. See for example, . . .

Coming Together: Portrait of a Family, by Winona Garmhausen. c.2004, ISBN 978-1-4140-4400-2 (ebook), ISBN 1-4140-4401-1 (paperback). - Winona Garmhausen's book provides a hint that John Loy was married some time before 1846 to a lady whose surname was "Hydaker". Once it occurred to me that this was a corruption of the surname name Heidegger, I was able to build a trail of plausible "evidence" pertaining to their lives in Baden.

Germans To Marion County, Ohio and Their Ancestors, Allen, L. Potts, 2010, ISBN 0788406035. - The book by A. Potts provides a likely hint as to the immigration of John and first family.

Other references will be cited as their information is presented.

Please direct comments and questions to me (Craig Rhombs) at [genealogist@rhombs.us](mailto:genealogist@rhombs.us) .

## Revision Record

- Rev. 5, 10/7/2020: Changes based on analysis of information in the Ortssippnebuch for Göbrichen, Baden.
- Rev. 4, 8/3/2020: Added some information about earlier ancestry in Baden and Württemberg based on data collected by "Tereni" at geneanet.com. Added information about a cousin that settled in OH as well (found through a genetic match). Added newly discovered emigration information.
- Rev. 3, 5/13/2019: Added information regarding another Loy family cluster in Crawford Co., OH, to the last section on Future Research.

# Johann Georg Lay a.k.a. John Loy

- Rev. 2, 7/11/2018: Corrected confusion between Andrew and Anthony Louth (brothers) in the section about a possible marriage of John to Catherine Klinger. Thanks to B.G. for pointing this out as well providing discussion regarding how tentative this section is.
- Rev. 1, 7/8/2018: Added information from Allen Co., IN, Library regarding possible third marriage for John.

# Johann Georg Lay a.k.a. John Loy

## Birth Family

I believe that John's name in Baden was actually Johann Georg Lay. Unfortunately, this appears to have been a common name so tracing his records is a little difficult. The location of Göbrichen is a common thread that makes the trace somewhat easier. Current day Göbrichen is just north of Pforzheim as shown on this contemporary map by the red arrow near Neulingen.

A quick summary is that John's father (another Johan Georg Lay) and mother (Christine Klauss) were married in Göbrichen in 1819. John was born in the subsequent year (8/15/1820).

(Another key location later in his life is Würm, indicated by a red pin south of Pforzheim. )



# Johann Georg Lay a.k.a. John Loy

A map of the area from the Meyers Gazetteer also follows to show a map that is more contemporary with the times being described. Göbrichen is indicated by the red teardrop. Würm is near the bottom center. See <https://www.meyersgaz.org/place/10584049>.





# Johann Georg Lay a.k.a. John Loy

According to the following marriage record provided by familysearch.org, John was the son of Johann Georg Lay and Christine Klauss. It shows that he was born on 8/15/1820.

Reference ID:

Name: Johann Georg Lay

Birth Date: 15 Aug 1820

Birthplace:

Age:

Spouse's Name: Sophia Kaelber

Spouse's Birth Date: 01 Nov 1820

Spouse's Birthplace:

Spouse's Age:

Event Date: 20 Feb 1848

Event Place: Würm, Baden, Germany

Father's Name: Johann Georg Lay

Mother's Name: Christine Klauss

Spouse's Father's Name:

Spouse's Mother's Name:

Race:

Marital Status:

Previous Wife's Name:

Spouse's Race:

Spouse's Marital Status:

Spouse's Previous Husband's Name:

Indexing Project (Batch) Number: M93741-2

System Origin: Germany-EASy

GS Film number: 1238352

Digital Folder Number: 4038836

Image Number:

Citing this Record:

"Deutschland Heiraten, 1558-1929," database, FamilySearch

(<https://familysearch.org/ark:/61903/1:1:NZM5-92D> : 9 March 2018), Johann Georg Lay and Sophia Kaelber, 20 Feb 1848; citing Würm, Baden, Germany; FHL microfilm 1,238,352.

# Johann Georg Lay a.k.a. John Loy

Following these clues actually leads to the following marriage record (1819) for John's parents, which shows more information about them.

Reference ID:

Name: Johann Georg Lay

Birth Date: 30 Apr 1792

Birthplace:

Age:

Spouse's Name: Christina Clauss

Spouse's Birth Date: 01 Oct 1797

Spouse's Birthplace:

Spouse's Age:

Event Date: 09 Dec 1819

Event Place: Göbrichen, Baden, Germany

Father's Name: Jacob Lay

Mother's Name: Margaretha Leopold

Spouse's Father's Name: Jacob Clauss

Spouse's Mother's Name: Susanna Bauer

Race:

Marital Status:

Previous Wife's Name:

Spouse's Race:

Spouse's Marital Status:

Spouse's Previous Husband's Name:

Indexing Project (Batch) Number: M93737-2

System Origin: Germany-EASy

GS Film number: 1238171

Digital Folder Number:

Image Number:

Citing this Record:

"Deutschland Heiraten, 1558-1929," database, FamilySearch

(<https://familysearch.org/ark:/61903/1:1:N855-PPG> : 11 February 2018), Johann Georg Lay and Christina Clauss, 09 Dec 1819; citing Göbrichen, Baden, Germany; FHL microfilm 1,238,171.

# Johann Georg Lay a.k.a. John Loy

Here is christening information for John's father.

Name: Johann Georg Lay  
Name Note:  
Titles and Terms:  
Event Date:  
Event Date: 1792  
Gender: Male  
Age:  
Race: White  
Birth Date: 30 Apr 1792  
Birth Year: 1792  
Birthplace:  
Christening Date: 01 May 1792  
Christening Place: Göbrichen, Baden, Germany  
Christening Age:  
Death Date: 18 Sep 1865  
Father's Name: Jacob Lay  
Father's Titles and Terms:  
Father's Birthplace:  
Father's Age:  
Mother's Name: Margarethe Leopold  
Mother's Titles and Terms:  
Mother's Birthplace:  
Mother's Age:  
Paternal Grandfather's Name:  
Paternal Grandmother's Name:  
Maternal Grandfather's Name:  
Maternal Grandmother's Name:  
Note:  
Reference ID:  
System Origin: Germany-EASy  
GS Film Number: 1238171  
Indexing Project (Batch) Number: C93737-2  
Citing this Record:  
"Deutschland Geburten und Taufen, 1558-1898," database, FamilySearch  
(<https://familysearch.org/ark:/61903/1:1:NNNN-QX1 : 10 February 2018>), Johann Georg Lay,  
01 May 1792; citing ; FHL microfilm 1,238,171.

# Johann Georg Lay a.k.a. John Loy

## Deeper Ancestry

I have received copies of the Ortssippenbuch for Gobrighen, and I have used the information to construct John's family tree. A researcher with the ID of "tereni" on geneanet.org has compiled quite a bit of information along with source citations as well. (See <https://gw.geneanet.org/tereni?lang=en&m=N&v=LAYH> .) Following is a summary of some this information in the form of a sketch of descendants of Peter Lay., who is the great great grandfather of Johann George Lay (b.1820 - a.k.a. John Loy).

Here is a sketch of some of the descendants of Peter Lay, leading to John Loy (Johann Georg Lay).

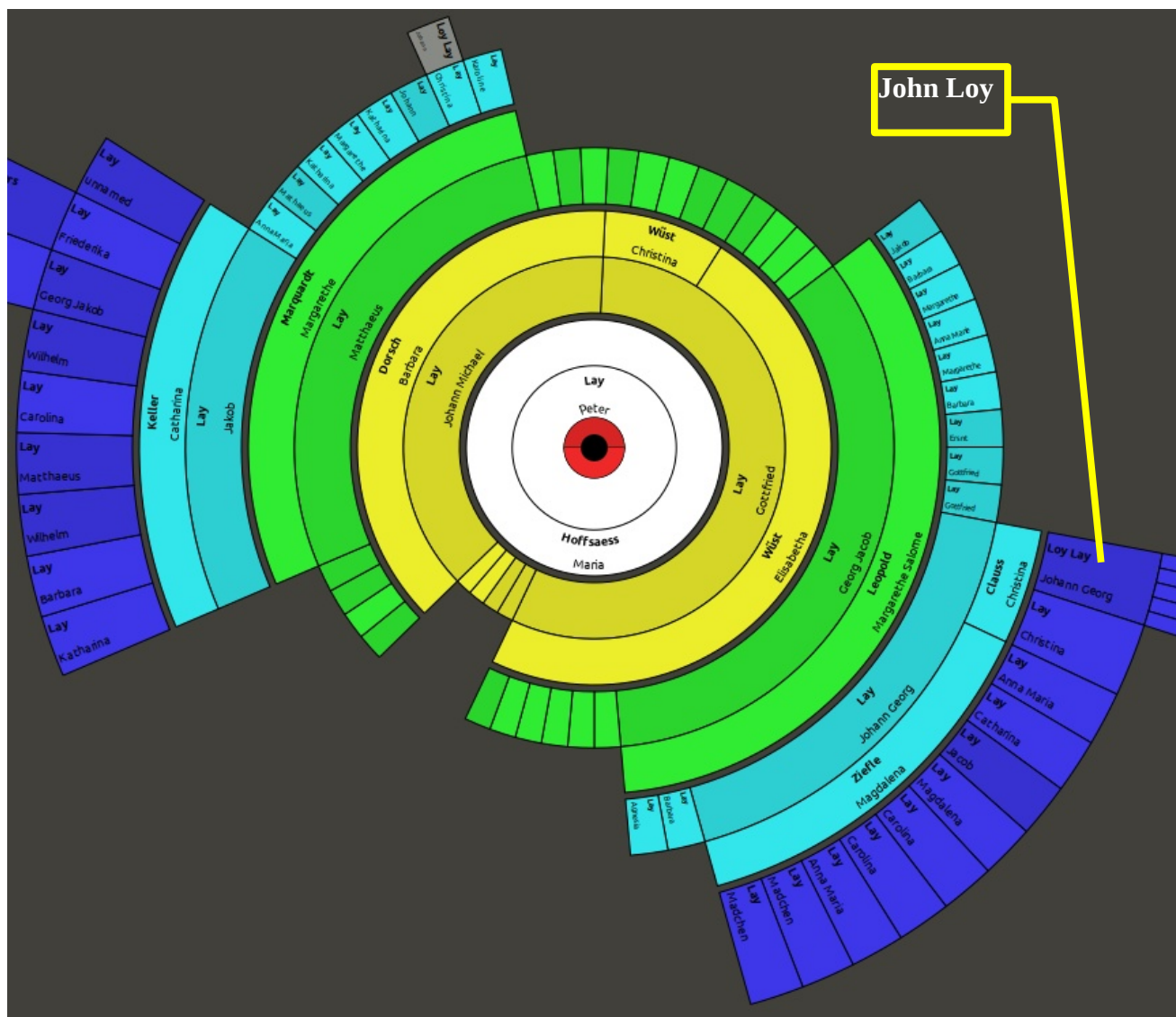

# Johann Georg Lay a.k.a. John Loy

Here are the immediate descendants of John's grandfather, Georg Jacob Lay.

John's father is Johann Georg (b.1792).

Many children and grandchildren of Ernst (b.1787), John's uncle, emigrated to the USA. In fact, it appears to me that all children that were living in 1850, except the eldest son Ernst (b.1814), moved from Göbrichen. Some emigrated to America or they had children that emigrated to America. It could be that as eldest son, Ernst took over his father's carpentry business. - The Elder Ernst's unmarried son Gottfried (b.1834) and unmarried daughter Rosina (b.1827) likely traveled to the USA in 1853. They could have traveled with John and his family for all I know. Also contributing to travel to the USA were the families of Barbara (b.1812), Catharina (b.1816), Jacob (b.1821), Georg Adam (b.1825).

The point is that John had cousins from this line in America, as well as possible traveling companions. This may be fertile ground for future research.

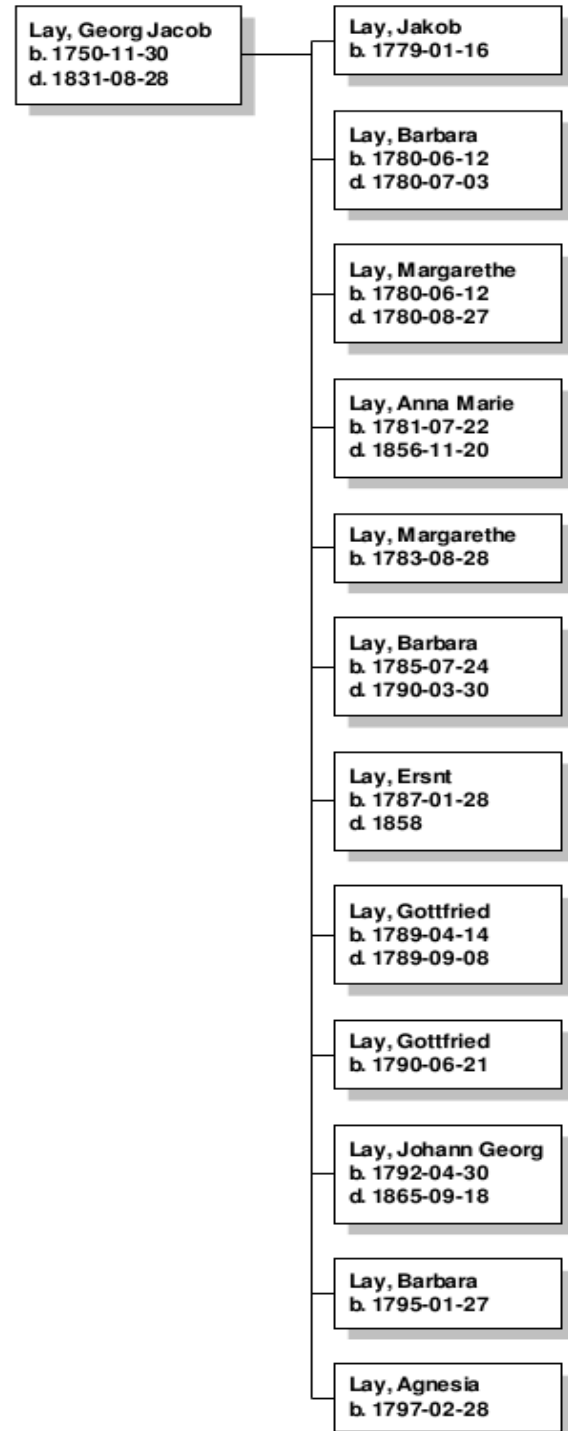

# Johann Georg Lay a.k.a. John Loy

Here are the descendants of John's cousin, Mattheaus. [Lay, Mattheaus is the first cousin twice removed (up) of John Loy. Their common ancestors are Lay, Peter and Hoffsaess, Maria.]

There are a number of reasons why offspring of Mattheaus and his wife Margaretha Marquardt are significant to John.

First, John married Mattheaus' daughter Christina (b.1815) in 1843. They had a child that survived less than a year, and the marriage ended in divorce.

Next, it is clear from genetic matching with some of my contemporaries and from various records that Mattheaus' son Jakob (b.1801) immigrated to Crawford County, OH. Various offspring of Jakob have left their mark in the Crawford area. Sister Christina also immigrated with Jacob in 1854.

Jakob's daughter Carolina (b.1838) married Gottlieb Ott (b.1837) and their line leads to a person whose DNA matching with me is consistent with the genealogy presented here.

Jakob's daughter Friederika (b.1843) married Martin Suhn and then James Myers and lived in OH.

I wonder if John knew of their presence so close to where he lived.

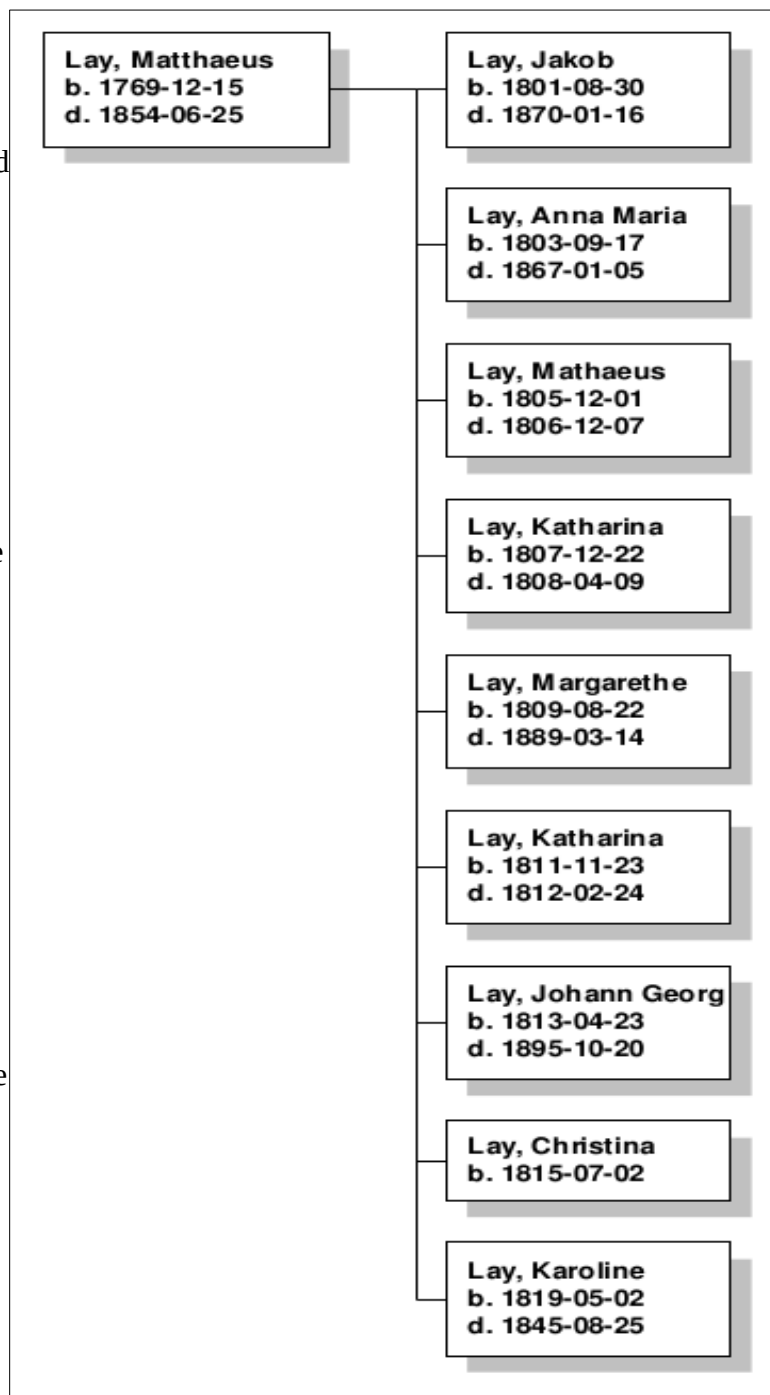

# Johann Georg Lay a.k.a. John Loy

## Early Marriages

John's first marriage was in 1843 to his second cousin, Christina, as mentioned above.

Then, the geneanet.org site also indicates that he may have been married to one Barbara Maier (b.1825), but I have not looked for supporting evidence of this. The Ortssippnebuch does not mention this marriage.

Then, there is the marriage to Sophia Kaelber.

## John's Marriage to Christina Lay

Following is a record of the younger Johann's marriage to Christina Lai in 1843. This means that Johann was married once prior to his marriage with Sophia Kaelber. Also, because of Christina's last name, I wonder if Johann was marrying a cousin.

Name: Johann Georg Lai  
Birth Date: 15 Aug 1820  
Birthplace:  
Age:  
Spouse's Name: Christina Lai  
Spouse's Birth Date: 02 Jul 1815  
Spouse's Birthplace:  
Spouse's Age:  
Event Date: 21 Feb 1843  
Event Place: Evangelisch, Goebriichen, Karlsruhe, Baden  
Father's Name: Johann Georg Lai  
Mother's Name: Christine Klaussin  
Spouse's Father's Name: Matthauss Lai  
Spouse's Mother's Name: Margaretha Marquardt  
Race:  
Marital Status:  
Previous Wife's Name:  
Spouse's Race:  
Spouse's Marital Status:  
Spouse's Previous Husband's Name:  
Indexing Project (Batch) Number: M93737-1  
System Origin: Germany-VR  
GS Film number: 1238252  
Reference ID: 2:SL7F1Q

# Johann Georg Lay a.k.a. John Loy

Citing this Record:

"Deutschland Heiraten, 1558-1929," database, FamilySearch (<https://familysearch.org/ark:/61903/1:1:VCB6-GXG> : accessed 7 June 2016), Johann Georg Lai and Christina Lai, 21 Feb 1843; citing Evangelisch, Goebrichen, Karlsruhe, Baden; FHL microfilm 1,238,252.

## First Child (with Christina Lay)

Here is a record of the first child. Unfortunately, the child did not survive very long – death on 2/6/1844.

Name: Christine Lai

Name Note:

Titles and Terms:

Event Date:

Event Date: 1843

Gender: Female

Age:

Race:

Birth Date: 29 Nov 1843

Birth Year: 1843

Birthplace: Göbrichen, Baden, Germany

Christening Date: 02 Dec 1843

Christening Place: Göbrichen, Baden, Germany

Christening Age:

Death Date: 06 Feb 1844

Father's Name: Johann Georg Lai

Father's Titles and Terms:

Father's Birthplace:

Father's Age:

Mother's Name: Christine Lai

Mother's Titles and Terms:

Mother's Birthplace:

Mother's Age:

Paternal Grandfather's Name:

Paternal Grandmother's Name:

Maternal Grandfather's Name:

Maternal Grandmother's Name:

Note:

Reference ID: 2:SL6B02

System Origin: Germany-EASy

GS Film Number: 1238252

Indexing Project (Batch) Number: C93737-1



# Johann Georg Lay a.k.a. John Loy

Citing this Record:

"Deutschland Geburten und Taufen, 1558-1898," database, FamilySearch (<https://familysearch.org/ark:/61903/1:1:NC8G-RB6> : accessed 7 June 2016), Johann Georg Lai in entry for Christine Lai, 02 Dec 1843; citing Göbrichen, Baden, Germany; FHL microfilm 1,238,252.

The Ortssippnebuch indicates that John and Christina were divorced in 1847.

## John's Marriage to Sophia Kaelber

As noted above, John was married to Sophia Kaelber on 2/20/1848 in Würm. ("Deutschland Heiraten, 1558-1929," database, FamilySearch (<https://familysearch.org/ark:/61903/1:1:NZM5-92D> : 9 March 2018), Johann Georg Lay and Sophia Kaelber, 20 Feb 1848; citing Würm, Baden, Germany; FHL microfilm 1,238,352.) This is slightly later than Winona Garmhausen had estimated in her book, but it seems to fit many facts.

According to the 1860 Federal Census, John's family consisted of five children – two that were born in Baden. (see "United States Census, 1860," database, FamilySearch (<https://familysearch.org/ark:/61903/1:1:MCGN-LRG> : accessed 12 December 2015), Samuel Loy in household of John Loy, Prospect Township, Marion, Ohio, United States; from "1860 U.S. Federal Census - Population," database, Fold3.com (<http://www.fold3.com> : n.d.); citing p. 165, household ID 1226, NARA microfilm publication M653 (Washington, D.C.: National Archives and Records Administration, n.d.); FHL microfilm 805,006.)

These foreign born children were . . .

John Loy	M	age 12	born in Baden
Catharine Loy	F	age 9	born in Baden

In fact, I have found some European records to support this. They follow.

Sophia Kaelber - mentioned in the record of Johann Georg Lay and Sophia Kaelber

Name

Johann Georg Lay

Birth Date

15 Aug 1820

Spouse's Name

Sophia Kaelber

Spouse's Birth Date

01 Nov 1820

Event Date

20 Feb 1848

Event Place

# Johann Georg Lay a.k.a. John Loy

Würm, Baden, Germany

Father's Name

Johann Georg Lay

Mother's Name

Christine Klauss

Citing this Record

"Deutschland Heiraten, 1558-1929," database, FamilySearch (<https://familysearch.org/ark:/61903/1:1:NZM5-928> : accessed 18 May 2016), Johann Georg Lay and Sophia Kaelber, 20 Feb 1848; citing Würm, Baden, Germany; FHL microfilm 1,238,352

## Children with Sophia: Katharina (9/26/1851) and Johann Georg (12/29/1848) and Mary (9/26/1853)

### Birth of Johann Georg Lay (i.e., John in the 1860 US census) on 12/29/1848 in Würm

Name: Johann Georg Lay

Name Note:

Titles and Terms:

Event Date:

Event Date: 1848

Gender: Male

Age:

Race:

Birth Date: 29 Dec 1848

Birth Year: 1848

Birthplace: Würm, Baden, Germany

Christening Date: 01 Jan 1849

Christening Place:

Christening Age:

Death Date:

Father's Name: Johann Georg Lay

...

Mother's Name: Sophia Kaelber

...

Note:

Reference ID:

System Origin: Germany-EASy

GS Film Number: 1238352

Indexing Project (Batch) Number: C93741-2

# Johann Georg Lay a.k.a. John Loy

Citing this Record:

"Deutschland Geburten und Taufen, 1558-1898," database, FamilySearch (<https://familysearch.org/ark:/61903/1:1:NLCY-V8R> : 9 March 2018), Johann Georg Lay in entry for Johann Georg Lay, 01 Jan 1849; citing Würm, Baden, Germany; FHL microfilm 1,238,352.

## **Birth of Katharina (i.e., Catherine in the 1860 US Census) on 9/26/1851 also in Würm**

Name: Katharina Lay

Name Note:

Titles and Terms:

Event Date:

Event Date: 1851

Gender: Female

Age:

Race:

Birth Date: 26 Sep 1851

Birth Year: 1851

Birthplace: Würm, Baden, Germany

Christening Date: 05 Oct 1851

Christening Place:

Christening Age:

Death Date:

Father's Name: Johann Georg Lay

...

Mother's Name: Sophia Kaelber

Mother's Titles and Terms:

Mother's Birthplace:

Mother's Age:

...

Note:

Reference ID:

System Origin: Germany-EASy

GS Film Number: 1238352

Indexing Project (Batch) Number: C93741-2

Citing this Record:

"Deutschland Geburten und Taufen, 1558-1898," database, FamilySearch (<https://familysearch.org/ark:/61903/1:1:N527-LX7> : 9 March 2018), Johann Georg Lay in entry for Katharina Lay, 05 Oct 1851; citing Würm, Baden, Germany; FHL microfilm 1,238,352.

# Johann Georg Lay a.k.a. John Loy

## Birth of Mary in OH on 9/26/1853

Some evidence indicates that John's third child, named Mary, age 7, in the 1860 Federal census, was in fact a child of John and Sophia. This reasoning is based on a death record for Mary that follows. It indicates that she was born in OH and that her mother's name was "Sophia Calver", which could be corruption of Sophia Kaelber. Immigration in 1853 supports this. See the Gobrichen Ortssippenbuch.

Name: Mary Kopp  
Titles and Terms (Original):  
Event Date: 09 Feb 1918  
Event Place: Chicago, Cook, Illinois  
Gender: Female  
Marital Status:  
Race:  
Age: 64  
Birth Year (Estimated): 1854  
Birth Date: 26 Sep 1853  
Birthplace: Ohio  
Father's Name: John Loy  
Father's Titles and Terms:  
Father's Birthplace: Germany  
Mother's Name: Sophia Calver  
Mother's Titles and Terms:  
Mother's Birthplace: Germany  
Occupation:  
Residence Place: 11446 State  
Address:  
Spouse's Name:  
Spouse's Titles and Terms (Original):  
Spouse's Birthplace:  
Burial Date: 12 Feb 1918  
Burial Place:  
Cemetery: Mt. Olivet  
Informant's Name:  
Additional Relatives:  
Digital Folder Number: 4030819  
Image Number: 1420  
GS Film number: 1852587  
Reference ID: rn 3864

# Johann Georg Lay a.k.a. John Loy

Citing this Record:

"Illinois Deaths and Stillbirths, 1916-1947," database, FamilySearch  
(<https://familysearch.org/ark:/61903/1:1:N3WS-SLG> : accessed 14 December  
2015), John Loy in entry for Mary Kopp, 09 Feb 1918; Public Board of  
Health, Archives, Springfield; FHL microfilm 1,852,587.

This leads to the conclusion that Sophia must have made it to the USA, where she gave birth to Mary. It also implies that immigration of the family took place some time prior to 1853 (Mary's birth in OH) and after 1851 (Catherine's birth in Baden). Also, because Sophia does not appear in US records in the 1850s, it is tempting to speculate based on this that she died some time between 1853 and 1857 (when John remarries). More will be said about this later.

# Johann Georg Lay a.k.a. John Loy

## Family Group Chart

A corresponding family group chart for this family follows.

Family Group Report			
<b>Husband: Loy, John</b>			
Birth	wurm, baden,germany - according to marriage record with Sophia Kaelber		
	1820-08-15	Baden, Germany	
Death	4/17/1892 actual death; maybe 4/21/1892 is the burial date		
	1892-04-17	Delphos, Allen, Ohio	
Father	Lay, Johann Georg		
Mother	Clauss, Christina		
<b>Wife: Kaelber, Sophia</b>			
Birth	eutingen (near Pforzheim)		
	1820-11-01	Eutingen, Karlsruhe, Baden, Baden, Germany	
Death	see note		
	1853-05-16	Baden, Germany	
Father	Kaelber, Friedrich		
Mother	Deiss, Sophia		
<b>Children</b>			
<b>1M</b>	<b>Loy, John Edwin</b>		
	Birth	1848-12-29	Baden, Germany
	Death	1902	Auglaize, Ohio
	Spouse	Parker, Catherine A.	
	Marriage	1872-07-27	Auglaize, Ohio, USA
<b>2F</b>	<b>Loy, Catherine L.</b>		
	Birth	1851-09-26	Baden, Germany
	Death	1930-05-14	Delphos, Allen, Ohio
	Spouse	Stopher, William	
	Marriage	1868-02-01	Auglaize, Ohio
<b>3F</b>	<b>Loy, Mary</b>		
	Birth	1853-09-26	Ohio
	Death	1918-02-09	Chicago, Cook, Illinois
	Spouse	Kopp, Francis	
	Marriage	1878-02-12	Allen, Ohio

# Johann Georg Lay a.k.a. John Loy

## Sophia Kaelber and Her First Marriage

### Birth and Death

Below are records that describe Sophia's birth and death. They indicate that she was born on 11/1/1820 in Eutingen and that she died on 5/16/1853. The location of her death is not given.

The date of death, however, needs to be considered in light of the birth of the daughter, Mary, who definitely seems to be hers and was born in OH. Here are the key dates that need to be resolved as well as their sources.

- Sophia dies May, 1853, according to the German records that follow
- Mary is born in 1853 +/-, according to the 1860 Federal Census
- Mary is born in March, 1854, according to the 1900 Federal Census
- Mary is born in September, 1853, according to her death certificate

So, it would not be unreasonable to assume for now that Sophia died in 1853 and that Mary was born in the same year. Perhaps the birth was associated with the death. This all should be validated through other independent sources, if they exist.

# Johann Georg Lay a.k.a. John Loy

The German records follow.

Deutschland Geburten und Taufen  
Name Sophia Kaelber  
Event Date 1820  
Gender Female  
Birth Date 01 Nov 1820  
Birth Year 1820  
Birthplace Evangelisch, Eutingen, Karlsruhe, Baden  
Christening Date 01 Nov 1820  
Christening Place Eutingen, Baden, Germany  
Death Date 16 May 1853  
Father's Name [Friedrich Kaelber](#)  
Mother's Name [Sophia Daissinn](#)  
Citing this Record

"Deutschland Geburten und Taufen, 1558-1898," database, *FamilySearch*  
(<https://familysearch.org/ark:/61903/1:1:NCD3-LNL> : accessed 18 May 2016), Sophia Kaelber, 01 Nov 1820; citing Evangelisch, Eutingen, Karlsruhe, Baden; FHL microfilm 1,238,344

Deutschland Geburten und Taufen  
Name Sophia Kaelber  
Gender Female  
Birthplace Evangelisch, Eutingen, Karlsruhe, Baden  
Christening Date 01 Nov 1820  
Christening Place Eutingen, Karlsruhe, Baden  
Death Date 16 May 1853  
Father's Name [Friedrich Kaelber](#)  
Mother's Name [Sophia Daissinn](#)  
Citing this Record

"Deutschland Geburten und Taufen, 1558-1898," database, *FamilySearch*  
(<https://familysearch.org/ark:/61903/1:1:N8HK-ZZF> : accessed 18 May 2016), Sophia Kaelber, 01 Nov 1820; citing Evangelisch, Eutingen, Karlsruhe, Baden; FHL microfilm 1,238,344

The location of Eutingen is shown on the following current map by the red pin – just NE of Pfozheim. A period map is also presented.



# Johann Georg Lay a.k.a. John Loy



# Johann Georg Lay a.k.a. John Loy

## Sophia's First Marriage

To resolve the assertion in W. Garmhausen's book that John's first wife was named "Hydaker", I explored the German records for Sophia in more detail. I did in fact discover that she had been married to one Jakob Friedrich Heidegger in 1842. I have not found a record of Jakob's death, but I suppose that it must have happened after the birth of their son, Wilhelm, in 1846.

Together Sophia and Jakob had four children as follows. (All were born in Würm in Baden.)

- unnamed (b. 1/30/1844, died a few days later)
- Sophia (4/9/1845)
- Friedrich (4/9/1845, survived for nearly one year)
- Wilhelm Martin (11/12/1846)

Here is a record of the marriage.

Reference ID:  
Name: Jacob Friedrich Heidegger  
Birth Date: 20 Sep 1804  
Birthplace:  
Age:  
Spouse's Name: Sophia Kaelber  
Spouse's Birth Date: 01 Nov 1820  
Spouse's Birthplace:  
Spouse's Age:  
Event Date: 18 Dec 1842  
Event Place: Würm, Baden, Germany  
Father's Name:  
Mother's Name:  
Spouse's Father's Name: Friedrich Kaelber  
Spouse's Mother's Name: Sophia Deiss  
...  
Spouse's Previous Husband's Name:  
Indexing Project (Batch) Number: M93741-2  
System Origin: Germany-EASy  
GS Film number: 1238352  
Digital Folder Number: 4038836  
Image Number:  
Citing this Record:  
"Deutschland Heiraten, 1558-1929," database, FamilySearch  
(<https://familysearch.org/ark:/61903/1:1:NZMP-BW6> : 9 March 2018), Jacob Friedrich Heidegger and Sophia Kaelber, 18 Dec 1842; citing Würm, Baden, Germany; FHL microfilm 1,238,352.

Here are records of their children in Baden. (Later I will present evidence that two of the children emigrated to the USA.)

# Johann Georg Lay a.k.a. John Loy

## unnamed child (b.1844, d.1844)

Name: Heidegger

Name Note:

Titles and Terms:

Event Date:

Event Date: 1844

Gender: Male

...

Birth Date: 30 Jan 1844

Birth Year: 1844

Birthplace: Würm, Baden, Germany

Christening Date:

Christening Place:

Christening Age:

Death Date: 02 Feb 1844

Father's Name: Jakob Friedrich Heidegger

Father's Titles and Terms:

Father's Birthplace:

Father's Age:

Mother's Name: Sophia Kaelber

Mother's Titles and Terms:

Mother's Birthplace:

Mother's Age:

...

Reference ID:

System Origin: Germany-EASy

GS Film Number: 1238352

Indexing Project (Batch) Number: C93741-2

Citing this Record:

"Deutschland Geburten und Taufen, 1558-1898," database, FamilySearch

(<https://familysearch.org/ark:/61903/1:1:NCDQ-9XG> : 9 March 2018), Sophia Kaelber in entry for Heidegger, ; citing Würm, Baden, Germany; FHL microfilm 1,238,352.

# Johann Georg Lay a.k.a. John Loy

## Sophia Heidegger (b.4/9/1845)

Name: Sophia Heidegger

Name Note:

Titles and Terms:

Event Date:

Event Date: 1845

Gender: Female

...

Birth Date: 09 Apr 1845

Birth Year: 1845

Birthplace: Würm, Baden, Germany

Christening Date: 13 Apr 1845

Christening Place:

Christening Age:

Death Date:

Father's Name: Jakob Friedrich Heidegger

Father's Titles and Terms:

Father's Birthplace:

Father's Age:

Mother's Name: Sophia Kaelber

...

Note:

Reference ID:

System Origin: Germany-EASy

GS Film Number: 1238352

Indexing Project (Batch) Number: C93741-2

Citing this Record:

"Deutschland Geburten und Taufen, 1558-1898," database, FamilySearch

(<https://familysearch.org/ark:/61903/1:1:NCDQ-MBK : 9 March 2018>), Jakob Friedrich

Heidegger in entry for Sophia Heidegger, 13 Apr 1845; citing Würm, Baden, Germany; FHL microfilm 1,238,352.

# Johann Georg Lay a.k.a. John Loy

## Friedrich Heidegger (b.1845, d.1846)

Name: Friedrich Heidegger

Name Note:

Titles and Terms:

Event Date:

Event Date: 1845

Gender: Male

Age:

Race:

Birth Date: 09 Apr 1845

Birth Year: 1845

Birthplace: Würm, Baden, Germany

Christening Date: 13 Apr 1845

Christening Place:

Christening Age:

Death Date: 12 Mar 1846

Father's Name: Jakob Friedrich Heidegger

Father's Titles and Terms:

Father's Birthplace:

Father's Age:

Mother's Name: Sophia Kaelber

...

Note:

Reference ID:

System Origin: Germany-EASy

GS Film Number: 1238352

Indexing Project (Batch) Number: C93741-2

Citing this Record:

"Deutschland Geburten und Taufen, 1558-1898," database, FamilySearch

(<https://familysearch.org/ark:/61903/1:1:NCDQ-9YQ> : 9 March 2018), Jakob Friedrich Heidegger in entry for Friedrich Heidegger, 13 Apr 1845; citing Würm, Baden, Germany; FHL microfilm 1,238,352.

# Johann Georg Lay a.k.a. John Loy

## Wilhelm Martin Heidegger (b. 11/12/1846)

Name: Wilhelm Martin Heidegger

Name Note:

Titles and Terms:

Event Date:

Event Date: 1846

Gender: Male

Age:

Race:

Birth Date: 12 Nov 1846

Birth Year: 1846

Birthplace: Würm, Baden, Germany

Christening Date: 15 Nov 1846

Christening Place:

Christening Age:

Death Date:

Father's Name: Jakob Friedrich Heidegger

Father's Titles and Terms:

Father's Birthplace:

Father's Age:

Mother's Name: Sophia Kaelber

...

Note:

Reference ID:

System Origin: Germany-EASy

GS Film Number: 1238352

Indexing Project (Batch) Number: C93741-2

Citing this Record:

"Deutschland Geburten und Taufen, 1558-1898," database, FamilySearch

(<https://familysearch.org/ark:/61903/1:1:NCDQ-SWG : 9 March 2018>), Jakob Friedrich Heidegger in entry for Wilhelm Martin Heidegger, 15 Nov 1846; citing Würm, Baden, Germany; FHL microfilm 1,238,352.

# Johann Georg Lay a.k.a. John Loy

## Evidence for Emigration of Children

I made a quick search of 1860 Federal Census records in Marion Co., OH, for people with the name Heidegger just to see what I would turn up. In fact I found two candidates that appear to match Sophia's surviving children, Sophia and Wilhelm. (This is the county where John Loy and his family appear in 1860.)

These records show what appear to be orphaned children, born in Baden, living in the house of other people from that part of the world.

I suspect that these children lived not too far from John Loy throughout their lives. It is interesting to speculate whether they actually interacted with each other and with John. (By the way, the 1900 Federal Census indicates that Sophia, child of Sophia and Jakob, immigrated in 1853.)

## Wilhelm/William in 1860

Name: William Hidaker

Titles and Terms:

Event Type: Census

Event Date: 1860

Event Place: Richland Township, Marion, Ohio, United States

Gender: Male

Age: 14

Race: White

Race (Original): [Blank]

Occupation:

Birth Year (Estimated): 1846

Birthplace: Baden

Page: 73

Household ID: 526

Affiliate Name: The U.S. National Archives and Records Administration (NARA)

Affiliate Publication Number: M653

Affiliate Film Number: 1006

GS Film Number: 805006

Digital Folder Number: 005170602

Image Number: 00269

Household	Role	Sex	Age	Birthplace
Jacob Kebrer		M	38	Baden
Caroline Kebrer		F	33	Baden

# Johann Georg Lay a.k.a. John Loy

Caroline Kebrer	F	17	Baden
Catharine Kebrer	F	12	Baden
Christena Kebrer	F	9	Baden
Jacobina Kebrer	F	7	Ohio
Jacob Kebrer	M	4	Ohio
Christian Kebrer	M	2	Ohio
William Hidaker	M	14	Baden

Citing this Record:

"United States Census, 1860", database with images, FamilySearch (<https://familysearch.org/ark:/61903/1:1:MCGN-VZH> : 13 December 2017), William Hidaker in entry for Jacob Kebrer, 1860.

## Wilhelm's Burial in 1928

William M Hydaker

Birth: 1846

Death: 1928 (aged 81–82)

Burial: Spencerville Cemetery, Spencerville, Allen County, Ohio, USA

Plot: Row 14

Memorial #: 24981406

Family Members

Spouse

Mary Catherine Mack Hydaker 1858-1917

Children

Fairy Hydaker Barnett 1879-1968

Albert C Hydaker 1880-1946

Ralph Isaac Hydaker 1886-1972

Mabel C Hydaker Miller 1889-1986

George Mack Hydaker 1894-1976

Walter Lynn Hydaker 1897-1980

Vernon E Hydaker 1899-1985

Created by: DUVCW (46829351)

Added: 1 Mar 2008

URL: <https://www.findagrave.com/memorial/24981406/william-hydaker>

Citation: Find A Grave, database and images (<https://www.findagrave.com> : accessed 02 July 2018), memorial page for William M Hydaker (1846–1928), Find A Grave Memorial no. 24981406, citing Spencerville Cemetery, Spencerville, Allen County, Ohio, USA ; Maintained by DUVCW (contributor 46829351) .



# Johann Georg Lay a.k.a. John Loy

## Sophia in 1860

Name: Sophia Hidaker  
Titles and Terms:  
Event Type: Census  
Event Date: 1860  
Event Place: Richland Township, Marion, Ohio, United States  
Gender: Female  
Age: 14  
Race: White  
Race (Original): [Blank]  
Occupation:  
Birth Year (Estimated): 1846  
Birthplace: Baden  
Page: 67  
Household ID: 472  
Affiliate Name: The U.S. National Archives and Records Administration (NARA)  
Affiliate Publication Number: M653  
Affiliate Film Number: 1006  
GS Film Number: 805006  
Digital Folder Number: 005170602  
Image Number: 00263

Household	Role	Sex	Age	Birthplace
Frederick Keller			M 70	Baden
Sophia Keller		F	68	Wurtemberg
Caleb Keller		M	22	Baden
Sophia Hidaker		F	14	Baden
Charles Shuler		M	13	Baden

### Citing this Record:

"United States Census, 1860", database with images, FamilySearch  
(<https://familysearch.org/ark:/61903/1:1:MCGN-JR7> : 13 December 2017), Sophia Hidaker in entry for Frederick Keller, 1860.

## Sophia Seibert's Death

Name: Sophia Hydecker Seibert  
Titles and Terms:  
Event Type: Death

# Johann Georg Lay a.k.a. John Loy

Event Date: 10 Dec 1915  
Event Place: Spencerville, Allen, Ohio  
Residence Place:  
Address:  
Gender: Female  
Age: 70  
Marital Status: Widowed  
Race: W  
Occupation: Retired  
Birth Date: 09 Apr 1845  
Birthplace: Germany  
Birth Year (Estimated): 1845  
Burial Date: 13 Dec 1915  
Burial Place: Spencerville  
Cemetery:  
Father's Name: Jacob Hydecker  
Father's Titles and Terms:  
Father's Birthplace: Germany  
Mother's Name: Sophia Kelber  
Mother's Titles and Terms:  
Mother's Birthplace: Germany  
Spouse's Name:  
Spouse's Titles and Terms:  
File Number: fn 63922  
GS Film number: 1983550  
Digital Folder Number: 004025084  
Image Number: 00793

## Citing this Record:

"Ohio Deaths, 1908-1953," database with images, FamilySearch  
(<https://familysearch.org/ark:/61903/1:1:X8FJ-CQS> : 9 March 2018), Sophia Hydecker Seibert, 10 Dec 1915; citing Spencerville, Allen, Ohio, reference fn 63922; FHL microfilm 1,983,550.

## **Sophia Seibert's Burial**

Sophia Hydecker Seibert  
Birth: 9 Apr 1845 Germany  
Death: 10 Dec 1915 (aged 70) Spencerville, Allen County, Ohio, USA  
Burial: Spencerville Cemetery, Spencerville, Allen County, Ohio, USA

# Johann Georg Lay a.k.a. John Loy

Plot: Middle Old Section-Row 20

Memorial #: 22156749

Family Members

Spouse

Jacob Seibert 1851-1909

Children

Mary Elizabeth Seibert Miller 1876-1966

Created by: DUVCW (46829351)

Added: 13 Oct 2007

URL: <https://www.findagrave.com/memorial/22156749>

Citation: Find A Grave, database and images (<https://www.findagrave.com> : accessed 02 July 2018), memorial page for Sophia Hydecker Seibert (9 Apr 1845–10 Dec 1915), Find A Grave Memorial no. 22156749, citing Spencerville Cemetery, Spencerville, Allen County, Ohio, USA ; Maintained by DUVCW (contributor 46829351) .

# Johann Georg Lay a.k.a. John Loy

## Emigration, Immigration, and Naturalization

### Emigration

I have discovered some Baden emigration records that likely have bearing on understanding the movements of John and other people with the Lay surname from the Pforzheim area.

The records can be found using <https://www.familysearch.org/search/catalog/258733?availability=Family%20History%20Library> .

Specifically, see

<https://familysearch.org/ark:/61903/3:1:3Q9M-CSVS-F3VC-M> (Jakob Lay emigration)

<https://familysearch.org/ark:/61903/3:1:3Q9M-CSVS-F388-Q> (Johan Georg Lay emigration)

<https://familysearch.org/ark:/61903/3:1:3Q9M-CSVS-F3X6-9> (summary of emigration by assorted people with the Lay surname)

The later is pictured below.

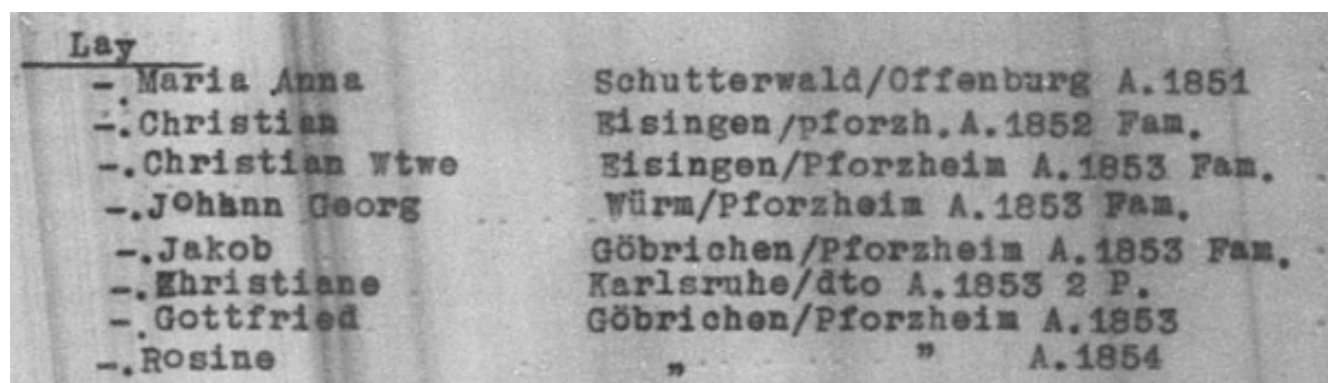

Lay	
- Maria Anna	Schutterwald/Offenburg A. 1851
- Christian	Eisingen/pforzh. A. 1852 Fam.
- Christian Wtwe	Eisingen/Pforzheim A. 1853 Fam.
- Johann Georg	Würm/Pforzheim A. 1853 Fam.
- Jakob	Göbrichen/Pforzheim A. 1853 Fam.
- Christiane	Karlsruhe/dto A. 1853 2 P.
- Gottfried	Göbrichen/Pforzheim A. 1853
- Rosine	" " A. 1854

This is consistent with transit to the USA in 1853 by Johann Georg (John) Lay. And, this fits nicely with the information that follows regarding immigration and naturalization.

### Immigration

As mentioned above, the dates associated with the death of John's wife, Sophia, and the birth of their third child, Mary, indicate that travel between Baden and OH must have taken place some time around 1853. This is a period of time just after the 1848 Revolution in the German states. Much has been written about this, so I just mention it in passing here.

# Johann Georg Lay a.k.a. John Loy

The book noted above by Allen Potts (page 57) does have an intriguing entry for one John Loy, a son John, and daughter Catherine for 1852.

Lowmiller, Mrs Margaret	May 7, 1819	May 2, 1899	Germany	
Loy, Catharina		1851	Baden	Loy, John
Loy, John		1845	Baden	Loy, John
Loy, John		1821	Baden	carpenter
Loyer, Carl	May	1839	Baden	
Loyer, George		1831	Baden	

...

Germany			Tu	Lowmiller, Henry
Baden	Loy, John	1852	Pr	
Baden	Loy, John	1852	Pr	
Baden	carpenter	1852	Pr	
Baden		1840	MT	widower
Baden			Pr	, Catharina

Key pieces of information are the names, birth dates (close, but I believe inaccurate based on other sources), country of origin (Baden), residence in Prospect Township, and immigration in 1852 (for all).

Sophia is not mentioned. This further deepens the mystery surrounding her arrival in the US and the circumstances of the birth of her daughter, Mary.

# Johann Georg Lay a.k.a. John Loy

## Naturalization

The Delaware Co. (OH) Records Center provided me with a document from 1858 that may record the naturalization of John Loy. A copy of the document follows. It records the naturalization of seven people – 4 from Ireland and 3 from Germany.

28

Tuesday September 28/58

x John Keely  
 x Michael O'Marra  
 x Michael Calahan  
 x Thomas Thute  
 x Jacob Koch  
 x William Koch  
 x John G. Lay

Naturalized  
 This day personally appeared in open court John Keely, Michael O'Marra, Michael Calahan & Thomas Thute, free white males over the age of twenty one years, natives of Ireland, and Jacob Koch, William Koch, & John G. Lay free white males over the age of twenty one years, natives of Germany, each having produced satisfactory evidence to the court that each one had in all respects complied with the laws regulating naturalization.

It is ordered that each one of them be admitted to all the rights and privileges of citizens of the United States, Whereupon the said John Keely, Michael O'Marra, Michael Calahan, Thomas Thute, Jacob Koch, William Koch, & John G. Lay each personally appeared in open court and made solemn oath to support the Constitution of the United States, and that they do absolutely and entirely renounce and abjure all allegiance and fidelity to any and every foreign Prince, Potentate, State, King or sovereignty whatever, and especially all allegiance and fidelity to the Governments whereof they have hitherto been citizens and subjects.

# Johann Georg Lay a.k.a. John Loy

The document is dated 9/28/1858. The names of the seven men are shown in the enlarged insert here.

The three “Germans” are Jacob Koch, William Koch, and John G. Loy/Ley/Lay.

The date of this document would fit well within the time-line described so far. (I understand that during this era, a person would declare his intention to become a citizen and five years later could file final papers to achieve naturalized status.) In other words, arrival in 1852 would allow reasonable time to accomplish naturalization in 1858.

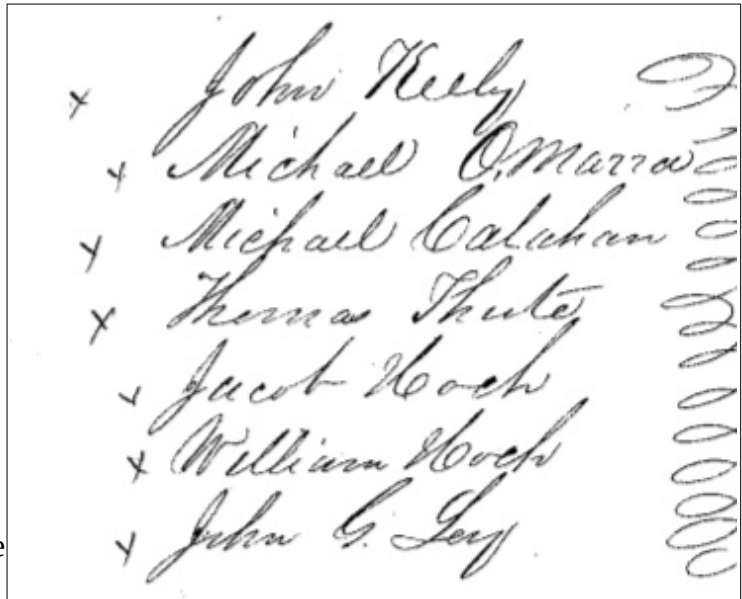

So, this is not definitely a record for John, but it easily could be based on the timing and the location of the court not far from John’s residence in Prospect Township.

By the way, a quick bit of research shows that the boundary between Marion and Delaware Counties, which is where John lived, had shifted some years before this. It is possible that Delaware was the preferred location to handle naturalization if you lived near the boundary between the counties, which is where John lived.

# Johann Georg Lay a.k.a. John Loy

## Marriage (to Susannah Snyder)

At this point, we have a pretty good case for the fact that John arrived in Prospect Township, Marion Co., OH, in about 1852. His Wife Sophia somehow arrived in the vicinity as well, and their third child (Mary) was born. Sophia dies in 1853. John works as a carpenter, perhaps a skill that he brought from Baden.

This, however, leaves him as single father, supporting three children (Mary, an infant, John, 5 years old, and Catherine, 2 years old). Somehow he made the situation work, but it is not surprising that he would have sought help and companionship. This he found in the person of one Susannah Snyder, who resided with her family in the nearby township of Waldo.

John and Susannah married in March, 1857. By the time of the 1860 Federal Census, their family consisted of John's original three children and two of their own. -

Name: Samuel Loy; Event Type: Census; Event Year: 1860  
Event Place: Prospect Township, Marion, Ohio, United States  
Gender: Male; Age: 1; Race: White  
Race (Original): [Blank]  
Birth Year (Estimated): 1859  
Birthplace: Ohio  
Page: 165  
Household ID: 1226  
Affiliate Name: The U.S. National Archives and Records Administration (NARA)  
Affiliate Publication Number: M653  
GS Film Number: 805006  
Digital Folder Number: 004282830  
Image Number: 00362

Household	Role	Gender	Age	Birthplace
John Loy		M	39	Baden
Susana Loy		F	26	Pennsylvania
John Loy		M	12	Baden
Catharine Loy		F	9	Baden
Mary Loy		F	7	Ohio
Christena Loy		F	3	Ohio
Samuel Loy		M	1	Ohio

Citing this Record:

"United States Census, 1860," database, FamilySearch (<https://familysearch.org/ark:/61903/1:1:MCGN->



# Johann Georg Lay a.k.a. John Loy

LRG : accessed 12 December 2015), Samuel Loy in household of John Loy, Prospect Township, Marion, Ohio, United States; from "1860 U.S. Federal Census - Population," database, Fold3.com (<http://www.fold3.com> : n.d.); citing p. 165, household ID 1226, NARA microfilm publication M653 (Washington, D.C.: National Archives and Records Administration, n.d.); FHL microfilm 805,006.

In 1864 they had another daughter, Sarah Ann. - Her 1946 obituary shows her birth date as 2/2/1864.

So, by 1864, there is a family consisting of 6 children, ranging in age from newborn to 16. My great grandfather, Sam was about 5 years old.

At about this time, Susannah no longer appears in records that have been found so far. We will see that the 1870 Federal Census does not show her. Exactly what happens is not at all clear and deserves more research.

Following is a family group chart for the Loy/Snyder family. Note that, where birth locations are found in the historical record for the children, none explicitly show Marion Co., OH, as the place where they were born. Also, note that the family is clearly shown as being in Marion Co. in 1860, however. Perhaps John's work (carpentry) made them a mobile family, or possibly just as likely recorded birth locations reflect inaccurate information and an association with Delphos, OH, which spans Allen and Van Wert Counties.

Here is a summary of birth locations per "official" records.

- Christena – Van Wert County, OH
- Sam – just Ohio (I have never seen anything more specific than this.)
- Sarah – Allen County, OH

# Johann Georg Lay a.k.a. John Loy

Family Group Report			
<b>Husband: Loy, John</b>			
Birth	wurm, baden,germany - according to marriage record with Sophia Kaelber		
	1820-08-15	Baden, Germany	
Death	4/17/1892 actual death; maybe 4/21/1892 is the burial date		
	1892-04-17	Delphos, Allen, Ohio	
Father	Lay, Johann Georg		
Mother	Clauss, Christina		
<b>Wife: Snyder, Susannah</b>			
Birth	according to the 1850 fed census		
	1832	Pennsylvania	
Death			
Father	Snyder, John		
Mother	unknown, Catherine		
<b>Children</b>			
<b>1F</b>	<b>Loy, Christena Caroline</b>		
	Birth	1857-09-25	Van Wert, OH, USA
	Death	1936-10-23	Delphos, Allen, Ohio
	Spouse	Moreo, Andrew	
	Marriage	1877-08-23	Landeck, OH, USA
<b>2M</b>	<b>Loy, Samuel</b>		
	Birth	1859-01-06	Ohio
	Death	1920-10-28	Adams, North Dakota
	Spouse	Allen, Anna Louella	
	Marriage	1895-12-25	Mound City, South Dakota
	Spouse	Rower, Margaret	
Marriage	1882-08-03	Allen, Ohio, USA	
<b>3F</b>	<b>Loy, Sarah Ann</b>		
	Birth	1864-02-02	Allen, Ohio, USA
	Death	1946-01-07	
	Spouse	Morgan, Charlie Ross	
	Marriage	1921-02-02	Van Wert, OH, USA
	Spouse	Archer, Samuel Washburn	
Marriage	1882-12-19	Allen County Ohio, Allen County, Ohio	

# Johann Georg Lay a.k.a. John Loy

## An Aside about Susannah's Birth Family

Here is what we know from the 1850 census about Susannah's family.

Name: John Snyder  
Event Type: Census  
Event Year: 1850  
Event Place: Waldo, Marion, Ohio, United States  
Gender: Male  
Age: 46  
Race: White  
Race (Original):  
Birth Year (Estimated): 1804  
Birthplace: Pennsylvania  
Household ID: 7  
House Number: 7  
Line Number: 9  
Affiliate Name: The U.S. National Archives and Records Administration (NARA)  
Affiliate Publication Number: M432  
Affiliate Film Number: 708  
GS Film Number: 444701  
Digital Folder Number: 004204493  
Image Number: 00008

Household	Role	Sex	Age	Birthplace
John Snyder		M	46	Pennsylvania
Catharine Snyder		F	55	Pennsylvania
Susanna Snyder		F	18	Pennsylvania
Elizabeth Snyder		F	16	Ohio
George Snyder		M	15	Ohio
Martha Snyder		F	9	Ohio

### Citing this Record:

"United States Census, 1850," database with images, FamilySearch (<https://familysearch.org/ark:/61903/1:1:MXQL-MV2> : 12 April 2016), John Snyder, Waldo, Marion, Ohio, United States; citing family 7, NARA microfilm publication M432 (Washington, D.C.: National Archives and Records Administration, n.d.).

# **Johann Georg Lay a.k.a. John Loy**

I have not found the family in 1860 or 1870. It is possible that Susannah's brother, George, became entangled in the Civil War. Her sisters, Martha and Elizabeth, could have married. This would have left parents, John and Catherine, alone and harder to trace. This is another potential future avenue of research that might accidentally reveal something about Susannah's life during the 1860s.

# Johann Georg Lay a.k.a. John Loy

## Activities From Mid-1860s Until Death

In this section I investigate some possible events in the life of John Loy. These are “stories” for now until additional corroborating evidence is uncovered.

What does seem certain is that the Loy family (minus Susannah?) moved from the Prospect (Marion County) area to Van Wert county (and Allen county). The cities of Van Wert and Delphos and Lima all seem to be significant in some ways.

Based on what follows, my current best guess is that the Loy/Snyder marriage ended some time between Feb, 1964 and Sept., 1965. This is the time period when I would expect to find death information or divorce information for Susannah. See what you think.

## Marriage to Mariah Augustine

Just to confuse the story of John’s life, a marriage record exists that might pertain to John. This is not proven, however, and if true the associated date would need to be reconciled with the birth date for Sarah Ann (Feb., 1864) and the fact that Sarah’s death certificate says that her mother’s name was Schneider (Snyder). Perhaps this marriage is for another John Loy in Marion Co. Many people have picked up on this marriage as fact for “our” John Loy, but I have seen no corroborating evidence.

For now, I choose to view this record as VERY suspicious and doubtful in terms of its applicability to our John Loy. This is another possible area of future research.

Here is the record of a marriage of one John Loy to Mariah Augustine on 12/10/1863 in Marion Co., OH.

Name: John Loy  
Titles and Terms:  
Event Type: Marriage  
Event Date: 10 Dec 1863  
Event Place: Marion, Ohio, United States  
Age: 21y or over

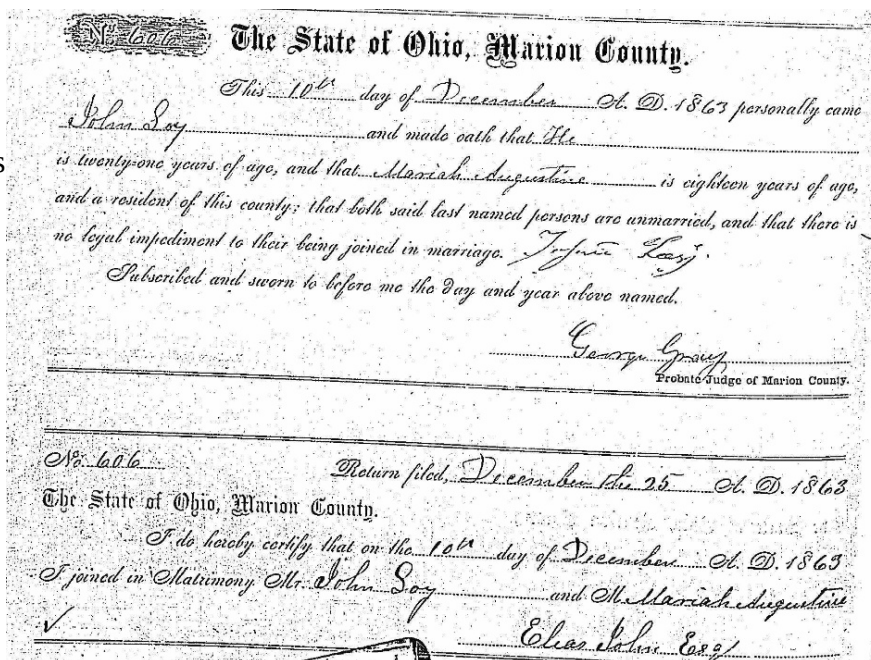

# Johann Georg Lay a.k.a. John Loy

Birth Date:

Birth Year (Estimated):

Birthplace:

Father's Name:

Father's Titles and Terms:

Mother's Name:

Mother's Titles and Terms:

Spouse's Name: Mariah Augustine

Spouse's Titles and Terms:

Spouse's Age: 18y or over

Spouse's Birth Year (Estimated):

Spouse's Birthplace:

Spouse's Father's Name:

Spouse's Father's Titles and Terms:

Spouse's Mother's Name:

Spouse's Mother's Titles and Terms:

Reference ID: V6, p302, no.606

GS Film Number: 384241

Digital Folder Number: 004257805

Image Number: 00195

Citing this Record:

"Ohio, County Marriages, 1789-2013," database with images, FamilySearch

(<https://familysearch.org/ark:/61903/1:1:XZCN-1YR : 10 February 2018>), John Loy and Mariah Augustine, 10 Dec 1863; citing Marion, Ohio, United States, reference V6, p302, no.606; county courthouses, Ohio; FHL microfilm 384,241.

# Johann Georg Lay a.k.a. John Loy

## Subsequent Marriage to Catherine Klinger Louth

In June, 2018, I contracted with researchers at the Allen Co. Public Library in Ft. Wayne, IN, to see if they could provide some clues regarding what might have happened to Susannah (Snyder) Loy. They were not able to answer that question directly, but they did turn up an interesting fresh twist to somethings that happened to John between the mid-1860s and the time of his death.

They turned up death and burial records for one Mrs. John Loy in Van Wert in 1887. Interestingly, they identified this person as Catherine Klinger, married to Andrew Louth in 1857, and John Lay in 1865. Assuming that this is correct, then John remarried to Catherine Klinger and they were subsequently separated or divorced. (She shows up divorced in the 1880 census.) The sequential evidence trail follows. (This is not a “clean” story and requires support from independent sources.)

# Johann Georg Lay a.k.a. John Loy

1857 marriage of Catherine Klinger to Andrew South (Louth) 3/21/1857.

“South” is probably a transcription error encouraged by the way the letter “L” was written in the original document.

Allen County, Ohio Marriages

SPOUSE # 1	SPOUSE #2	MONTH	DA	YEAR	OFFICIAL	BK	PG
Snyder Josiah	Reed Clarissa	July	06	1862	Webster B. A. - Mg	A	434
Snyder Levi	Mayers Lydia	December	07	1865	Mell John - JP	B	136
Snyder Levina	Moyers Thomas C	April	10	1866	Mell John - JP	B	170
Snyder Lucy S.	Everett Jonathan L.	July	24	1860	Shipley George - JP	A	328
Snyder Marilla	Reed Arthur	May	26	1863	Webster Barton A.	A	474
Snyder Peter	Edgecomb Clarinda	April	09	1840	Hartshorn Edward - JP	BK 1	119
Snyder Peter	Collar Ellen	September	08	1868	Maltbie H. - Mg	B	347
Snyder Susanna	Downhour Barney	September	05	1862	Miller John F. - JP	A	446
Snyder Susannah	Bodenbander Henry	February	03	1848	Rogers John - JP	BK 2	196
Snyder Susannah	Shockey Samuel A.	September	02	1852	Shockey John - Mg	A	017
Snyder Thomas	York Mary J	May	24	1866	Knott Wm - JP	B	177
Soloman Adam L	Michael Melinda	December	21	1865	Krebs A. R. - Mg	B	140
Soloman William	Jones Adaline	November	27	1865	No Return	B	132
Soloman William	Jones Adaline	November	27	1865	Probate Judge	B	132
Solomon George	Lloyd Catharine	April	24	1860	Sheply George - JP	A	319
Solomon Henry	Downing Sarah	April	03	1862	Faus William	A	422
Solomon Isaac	Close Ruth Jane	April	06	1858	Goble George W. - JP	A	228
Solomon Lydia C.	Driver Jacob	September	18	1859	Brower Daniel	A	288
Sonafrank Elizabeth	Shearer Isaac	June	06	1850	Hadsell Anson M. - JP	BK 3	020
Sonafrank John	Stuckmeyer Mary	March	09	1847	Hartshorn Edward - JP	BK 2	151
Sotell Charles	Dalla Louisa	March	15	1860	Shepley George - JP	A	312
Sours Jacob	Herring Harriet	February	01	1849	Herring Philip - JP	BK 2	141
South Andrew	Klinger Catharine	March	21	1857	Overmyer Geirge W. - JP	A	186
South Catharine	Oscs John	October	30	1857	Overmyer George W. - JP	A	209
South Charlotte	Crossley Samuel	July	31	1853	Hardesty Isaac - JP	A	050
South Elizabeth	Kleinhans Christopher	January	17	1857	Overmyer George W. - JP	A	182
South Emaline E.	Elliott Benjamin D.	June	06	1850	Darling D. P. - JP	BK 3	021
South Helena	Lux Louis	July	22	1862	Griffith O. E. - JP	A	435
South John	Trusdale Mary Samantha	May	22	1851	Darling D. P. - JP	BK 3	066
South Rebecca	Bowersox Valentine	April	03	1858	Westbay John - JP	A	231
South Washington	Bourts Sarah	July	08	1852	Darling D. P. - JP	A	012
Southworth Benjamin F.	Sakemiller Elizabeth	December	14	1849	Mormon Wm. - JP	BK 3	001
Southworth Benjamin P.	Moore Sarah	August	18	1856	Moorman Wm. - Elder	A	165
Sowers Daniel	Thompson Sarah J.	October	29	1868	Krebs A. R. - Mg	B	356
Sowers David	Michael Catharine	November	15	1868	Miller Daniel - VDM	B	360
Sowers George	Reese Elizabeth	March	22	1857	Krebs A. R. - Mg	A	188
Sowers John	Shrove Catharine	July	17	1854	No Return	A	084
Sowers Mary	Miller Henry	November	14	1863	Mell John - JP	B	016
Spalinger Barbara	Gammatter Jacob	September	03	1865	Grading Peter - Mg	B	105
Spalinger Ulrich	Geiger Barbary	June	23	1853	Steiner Ulrich - Mg	A	048
Spangenberg Charles	Haller Catharine	January	11	1847	Schemmel Conrad - JP	BK 2	144
Spangler Elizabeth	Baker Samuel	May	15	1849	Boyer Daniel - JP	BK 2	257
Spangler George	Hahn Dorothy	April	11	1843	Doner Abraham - Rev	BK 2	013
Spangler Lemech	Miller Sarah	January	05	1854	Herring Phillip - JP	A	066
Spangler Mabel	Stemen Samuel	September	07	1847	No Return	BK 2	177
Spangler Malinda	Miller Curtis	May	10	1860	Herring Lewis - JP	A	321
Spangler Maria	Roush Joseph	October	17	1861	Bell Freeman - JP	A	405
Spangler Rachel	Conrad Emanuel	December	08	1868	Bartholamew A. S.	B	363
Spangler Rebecca	Meyers Daniel	April	19	1849	Griffiths Joseph Jr. - JP	BK 2	253
Spangler Sarah	Fasnacht Wesley	May	24	1849	Boyer Daniel - JP	BK 2	258
Spangler Sophia	Tester George W.	June	19	1851	Ward George - JP	BK 3	069
Spangler Sophia	Keller Abraham	December	21	1862	Ditto Richard W. - JP	A	456
Spangler Susanna	Miller William	February	21	1858	Herring Lewis - JP	A	224
Spargo Sarah	VanHorn William	June	27	1845	McLean John - JP	BK 2	081
Spaulding Lee	Dickinson Marietta	May	09	1869	Young Isaac - Mg	B	389
Speaker William	Edgell Louise	September	07	1865	Krebs A. R. - Mg	B	107
Spear Susan	Mechling William L.	February	25	1869	Krebs A. R. - Mg	B	379





# Johann Georg Lay a.k.a. John Loy

Marriage of  
Catherine Lauth  
(Louth) to John  
Loy 9/28/1865.

## Allen County, Ohio Marriages

SPOUSE # 1	SPOUSE #2	MONTH	DA	YEAR	OFFICIAL	BK	PG
Langshaw Mary	Vannatta J. D.	October	15	1866	Kennedy Oliver - Mg	B	206
Langstaff Ann M.	Maltbie Thomas A.	December	16	1869	Maltbie H. - Mg	B	425
Lanning Benjamin	Bobb Anna	July	03	1836	Spurrier Beal - JP	BK 1	054
Lantz G. E.	Lawrence Angeline	August	01	1861	Griffith O. E. - JP	A	391
Laoghridge Margaret Jane	Bimel John	April	05	1853	Roberts J. B.	A	040
Larue William A	Helser Lucinda	July	22	1866	Corbett T W - Mg	B	187
Lathers Milly	Fair Jesse	October	22	1848	King Isaac - JP	BK 2	229
Lathrop Fanny Mrs.	Hover Ezekiel	December	23	1850	Wilcox Ralph	BK 3	046
Latimer Mary J	McKee Judson	April	27	1865	Tucker N. - JP	B	086
Laudich Elizabeth	Babb John	March	29	1839	Ide L. H. - JP	BK 1	101
Laudick Louis	Miller Clarissa Jane	September	23	1852	Shockey John - JP	A	019
Laughridge James	Weaver Eve	January	20	1850	Schooler Isaac - JP	BK 3	006
Laughridge Jane	Miller George	January	01	1852	Roberts Josiah B. - JP	BK 3	092
Laurence Hannah	Bowers Elijah D.	August	30	1846	Roberts J. B.	BK 2	127
Laurence Mary	Reece Alfred	April	25	1839	Wever Barnet - JP	BK 1	104
Laurence Ossa	Harrison Sarah J.	July	03	1867	White Eli - JP	B	259
Laurend Orange	Dering Clarinda	August	04	1856	Hall J. B. - JP	A	163
Lause Balz Henry	Moller Mary Elizabeth	March	24	1849	Bredeick J. O.	BK 2	248
Lause Catharine	Beckman Frank	May	24	1864	Stifenten Andrew - Min.	B	043
Lauth Catherine	Lay John	September	28	1865	Tucker A. - JP	B	113
Lauth Phillip	Moss Sarah Ann	February	18	1864	Hill John G. - JP	B	030
Lavato Mary	Kelly John	November	27	1865	Murphy E J - Mg	B	132
Lawberton William H	Nye Martha Ellen	October	05	1865	Ramsey Samuel - Rev	B	115
Lawlor P. H.	Keeth Johanna	February	13	1868	Kearney J. G. - Pastor	B	313
Lawrance Charlotta	Gilbert Jesse S.	November	18	1852	Griffith Thomas	A	028
Lawrance Christenay	Keith William D.	May	24	1853	Webster John - JP	A	044
Lawrence Angeline	Lantz G. E.	August	01	1861	Griffith O. E. - JP	A	391
Lawrence James	Shaver Matilda Jane	May	03	1868	Baker W. L. - JP	B	326
Lawrence John	Budd Asenath	March	19	1857	Wykes J. - Min.	A	187
Lawrence Levi	Crist Jemima Catharine	March	24	1861	DeLeal J. S. - Mg	A	375
Lawrence Lucy	Bailey Bradrick	August	30	1845	Watts James - JP	BK 2	084
Lawrence Mary A.	Crist John J.	August	08	1858	Miller John F. - JP	A	241
Lawrence Mary Jane	Eubanks Joseph	January	24	1864	Miller John F. - JP	B	025
Lawrence Moses	Walton Sarah Emily	February	19	1846	Reece William - JP	BK 2	101
Lawrence Patience	Hurlburt C. W.	June	26	1853	Webster John - JP	A	047
Lawrence Sarah	Brown Levi	July	19	1855	Griffith Thomas - Rev.	A	128
Lawrence Sarah Mariah	Gulliver Aaron Jackson	May	23	1844	Bresler Joseph - JP	BK 2	047
Lawrence Susan	Atkinson Evan G.	September	17	1848	Roberts J. B. - JP	BK 2	221
Lay John	Lauth Catherine	September	28	1865	Tucker A. - JP	B	113
Laycock David W.	Schofield Rebecca	October	28	1856	Shaffer John - JP	A	171
Laycock Mary E.	Ingledue Martin H.	February	12	1863	Bulle D. - Min	A	463
Laycock Rebecca	Berry John C.	November	27	1862	Winter W. W.	A	454
Laycock Sarah A	Worrill Jonathan	December	28	1865	Tucker A. - JP	B	142
Layfever William	Bird Sarah	July	24	1855	Delzell Thomas - JP	A	128
Layman Jacob	Hoover Jane	April	25	1865	Cunningham E. B. - JP	B	084
Layman Mary	Neiswander Abraham M	March	10	1866	Cunningham E. B. - JP	B	161
Layton Mary Jane	Copeland Amos	November	23	1839	Harvey Enoch - Mg	BK 1	110
Layton Robert C.	Corder Martha L.	March	25	1841	Metheany Richard - JP	BK 1	140
Layton William V. M.	Waggoner Rebecca	April	10	1846	Cheevers James S. - JP	BK 2	109
Leach Asa	Mull Mary Jane	August	16	1854	Hurd M. K. - Mg	A	086
Leach George W.	Sifert Mary Ann	June	04	1867	Kennedy Oliver - Mg	B	257
Leach John H.	McClure Elizabeth	November	11	1849	Craig Andrew - JP	BK 2	281
Leach William T.	Povenmoyer Lance	December	04	1851	Hering Philip - JP	BK 3	089
Leas Catharine	Donhaiser Adam	January	24	1858	Overmyer George - JP	A	222
Leas John	Hartlain Anna	April	28	1861	Alstatter Frederick - Evang.	A	376
Leasure Harriet	Harris Samuel	October	18	1866	Brice W. K. - Min.	B	204
Leasy David E	McCray Jennie	August	23	1866	Martz Michael - ECC	B	192



# Johann Georg Lay a.k.a. John Loy

Death / burial of “Mrs. Loy.”

Under burials with no monuments in the document whose title page is shown at the right, Mrs. Loy is shown.

You will find the page that follows. Note the very first line.

THE VAN WERT COUNTY CHAPTER  
OF THE  
OHIO GENEALOGICAL SOCIETY

#### 2008 OFFICERS

Michelle Thomas  
Carol Thomas  
Connie Swander  
Deb Berkebile  
Louis Thomas

President  
Recording and Corresponding Secretary  
Treasurer  
Immediate Past President  
Trustee



Copyright 2009 ©  
by  
The Van Wert County Chapter  
of the  
Ohio Genealogical Society

ii

# Johann Georg Lay a.k.a. John Loy

WOODLAND CEMETERY  
VOL III 2nd Edition



21	LOY, Mrs	-	
45	LUELLEN, James P	-	
53	LUMBARD, James	-	
26	LUSK, Infant	-	Inf of Russell
23	LUSK, Walter	-	
23	LUSK, Infant	-	Inf of Walter
26	LYNCH, Hugh V	-	
53	LYNCH, John	-	
34	LYTLE, Infant	-	Inf of WH
53	MADDEN, Barney	-	
26	MAGGIN, Patreca A	-	
21	MAGNER, Infant	-	
21	MAGNER, Children	-	
51	MAHAN, James A M	-	
V	MALICK, Elizabeth	-	
V	MALICK, Hugh	-	
V	MALICK, Infant	-	Inf of John
E	MALICK, Mattie	-	
20	MALIGHAN, Jennie	-	
44	MALLONEE, Daughter	-	d/o W E
20	MALOMEY, Mrs John	-	
22	MANSHIP, Mary	-	
24	MARBLE, Cordelia M	-	
27	MARCUM, Jessie	-	
43	MARKIS, Helen	-	
43	MARKIS, Helen	-	
44	MARKLEY, Belle MILLER	-	
43	MARKUS, Wm	-	
42	MARSH, Chester S	-	
36	MARSHALL, Blanch	-	
66	MARSHALL, Brunetta	-	
66	MARSHALL, Elizabeth Ellen	-	
66	MARSHALL, George W	-	
23	MARSHALL, James	-	
66	MARSHALL, James	-	
66	MARSHALL, Laura	-	
22	MARSHALL, Letty	-	
22	MARSHALL, May	-	
23	MARSHALL, Rehua	-	
22	MARSHALL, Thomas	-	
68	MARTIN, Cromwell Ada	-	
43	MARTIN, Byron F	-	
66	MARTIN, Catherine	-	
42	MARTIN, Dorothy	-	
13	MARTIN, Fearl	-	
45	MARTIN, Frances Emma	-	
36	MARTIN, Infant	-	Inf of Dale

620

# Johann Georg Lay a.k.a. John Loy

Here is a corresponding news article and some confirming evidence that we are tracking the right person. First an article from the 12/9/1887 "Van Wert Weekly Bulletin". Then a copy of the death certificate for Sophia Barlow, a daughter from the marriage of Catherine to Andrew Louth. Note that Sophia is born in 1859 in Jennings Twp in Van Wert Co. This becomes important later when we look at the 1870 Federal Census.

*Van Wert Weekly Bulletin  
Fri, 9 Dec 1887*

Deaths.

Mrs. John Loy died at her home on South Tyler street and was buried in Woodland on last Friday.

PROBATE COURT, VAN WERT COUNTY, OHIO.  
MARRIAGE LICENSE APPLICATION.

In the Matter of ) 1923 ✓  
W. M. Ralston )  
and )  
Sophia Barlow )

To the Honorable Judge of the Probate Court of said County.

The undersigned respectfully make application for a Marriage License for said parties, and upon oath state:

That said W. M. Ralston is 28 years of age on the 5 day of Feb 1923  
his residence is Rockford Ohio  
his place of birth is Van Wert County Ohio  
his occupation is Farmer  
his father's name is John A. Ralston  
his mother's maiden name was Mahala Pixler  
that he was never previously married  
and that he has no wife living.

That said Sophia Barlow is 66 years of age on the 17 day of February 1923  
her residence is Van Wert Van Wert County, Ohio,  
her place of birth is Jennings Twp. V.  
her occupation is Domestic  
her father's name is Andrew Louth  
her mother's maiden name was Catherine Kluges  
that she was never previously married  
and is never a widow or divorced woman, her married name being Barlow  
that she has no husband living.

That neither of said parties is an habitual drunkard, epileptic, imbecile or insane, or under the influence of any intoxicating liquor or narcotic drug.  
Said parties are not nearer of kin than second cousins, and there is no legal impediment to their marriage.  
It is expected that

The Probate Judge, being satisfied that there is no legal impediment to said marriage, a license therefore is hereby granted and issued to said parties this 11 day of December 1923

W. M. Ralston is to solemnize the marriage of said parties.  
Sophia Barlow Swore to before me, and signed in my presence.  
this 11 day of December 1923

Charles E. Lawhead Probate Judge. Hannet Jones Probate Judge-Deputy Clerk

THE STATE OF OHIO, VAN WERT COUNTY, SS.: \_\_\_\_\_ of \_\_\_\_\_ hereby give consent to the marriage of the said \_\_\_\_\_ to \_\_\_\_\_, the said \_\_\_\_\_ being under the age of \_\_\_\_\_ years, to-wit: \_\_\_\_\_ years of age. Dated the \_\_\_\_\_ day of \_\_\_\_\_ 19\_\_\_\_

Attesting Witnesses: \_\_\_\_\_

MARRIAGE CERTIFICATE.  
THE STATE OF OHIO, VAN WERT COUNTY, SS.  
I Do Hereby Certify, That on the 12 day of December A. D. 1923, I solemnized the Marriage of Mr. W. M. Ralston with Mrs. Sophia Barlow  
Filed and Recorded 12 - 14 1923  
Charles E. Lawhead Probate Judge. Geo B. Brantner Secy. Van Wert

# Johann Georg Lay a.k.a. John Loy

## The 1870 Federal Census

By the time of the 1870 census, Loy family members would have had the following approximate ages.

- John: 50
- Susannah: 38 (?)
- John: 22 (about to be married to Catherine Parker)
- Catherine: 19 (already married to William Stopher)
- Mary: 17 (within 8 years of marriage to Francis Kopp)
- Christena: 13 (within 7 years of marriage to Andrew Moreo)
- Sam: 11 (within 12 years of marriage to Margaret Rower, 25 years from marriage to Anna Allen)
- Sarah: 6 (within 12 years of marriage to Samuel Archer)

There are two records of interest from the 1870 census. Both confirm that John and family have relocated farther west to the area of Van Wert County. One record from June shows John alone as a carpenter (the expected occupation), but the other may show him and some of his children with another family 2 months later. Here's the first (simple, indisputable) record for the Village of Van Wert.

Page No. 38 } Inquiries numbered 7, 16, and 17 are not to be asked in respect to infants. Inquiries numbered 11, 12, 15, 16, 17, 19, and 20 are to be answered (if at all) merely by an affirmative mark, as in the township of Pleasant

SCHEDULE 1.—Inhabitants in The Village of Van Wert, in the County of Van Wert, State of Ohio, enumerated by me on the 9th day of June, 1870.

Post Office: Van Wert Ohio G. M. Schaefer, Ass't Marshal.

38	Loy John	50	m	w	Carpenter	1	290	Baden	1	1
----	----------	----	---	---	-----------	---	-----	-------	---	---

# Johann Georg Lay a.k.a. John Loy

Next is the record for Jennings Township in Van Wert Co. Jennings Twp is southeast of the town of Van Wert and southwest of Delphos as shown on the map that follows.



Page No. 19 } Inquiries numbered 7, 16, and 17 are not to be asked in respect to infants. Inquiries numbered 11, 12, 15, 16, 17, 19, and 20 are to be answered (if at all) merely by an affirmative mark, as /.

SCHEDULE I.—Inhabitants in Jennings Township, in the County of Van Wert, State of Ohio, enumerated by me on the 10 day of August, 1870.

Post Office: Auglaize Ohio 287  
Geo. W. Alexander, Ass't Marshal.

...

33	91	91	Loy John	30	M	W	Summer	1000	1835	Baden	1	1	1
34			Katharine	60	F	W	Wedding House			Kuse Darmstadt	1	1	
35			Mary	16	F	W				Ohio	1	1	
36			Jetta	13	F	W				Ohio	1	1	
37			Lizzie	12	F	W				Ohio	1	1	
38			Sophia	11	F	W				Ohio	1	1	
39			Samuel	11	M	W				Ohio	1	1	
40			Sarah	7	F	W				Ohio	1	1	

...

1			Mary M	6	F	W				Ohio			
---	--	--	--------	---	---	---	--	--	--	------	--	--	--

# Johann Georg Lay a.k.a. John Loy

In this second record, there are some things that make you think that part of the Loy family is present in this household. Namely, . . .

- John Loy has the right age (50), but farming is shown as an occupation – not carpentry.
- Mary has about the right age (16 versus 17)
- Christena (Tena) is 13 as expected.
- Sam is the right age (11).
- Sarah is about the right age (7 versus 6).
- Other people are present that do not appear to be part of the original Loy family. Quite possibly this is the family of Catherine Louth (after her divorce/separation from her husband Andrew). This would fit quite nicely with the information proposed by the Allen Co. Library researchers. However, for this to be true, the age of Catherine would need to be wrong (60 versus other estimates that would put her age at about 50 in 1860).
  - Catherine, age 60, from Hesse Darmstadt
  - Lizzie, age 12, born in OH
  - Sophia, age 11, born in OH
  - Mary M, age 6, born in OH

If this second record represents a blending of the Loy family with another, then John's oldest children, John (22) and Catherine (19) are elsewhere. Catherine is married to William Stopher, but I have not found John, who is clearly old enough to be working on his own. This makes sense.

Susannah is not present in either record. Her whereabouts are a mystery. I am inclined to think that Susannah has died at this point, perhaps at the birth of Sarah Ann in about 1864. John has moved west from Marion Co., and, while he does carpentry in Van Wert, he also has property, perhaps through his wife, Catherine, in Jennings township. (There were many Louth families in Jennings Township at the time.)

Let's see whether or not this can play out reasonably with the 1860 and 1870 federal census enumerations for Jennings Twp.

# Johann Georg Lay a.k.a. John Loy

Here is a page from the 1860 census for the same township. It shows the Anthony Louth family. Anthony was a brother to Andrew. The purpose of this is just to demonstrate the presence of another Louth family in the area, near a Hance family.

1860 United States Federal Census for Richard Hance								
Ohio > Van Wert > Jennings								
Dwellin No.	Family No.	Name	Sex	Color	Occupation	Real Estate	Personal Estate	Birthplace
		Richard Hance	49	M		800	295	Ky
		Mary	32	F				Ky
		John L.	22	M				Ky
		Vincint	17	M				"
		Marinda	13	F				"
		Thomas	11	M				"
		Columbus	5	M				"
		Benny Galif	13	M				"
		Adeline	11	F				"
		John	6	M				"
		Kellen	4	F				"
750	744	Christopher Dickey	43	M		1000	175	"
		Marantha	29	F				"
		Sarah J.	8	F				"
		Amanda	7	F				"
		William D.	3	M				"
751	745	Anthony Louth	30	M		275	105	Keep Sanded
		Catharine	30	F				"
		John	8	M				"
		Catharine	4	F				"
		Christ	2	M				"
		Phillip B.	1/2	M				"



# Johann Georg Lay a.k.a. John Loy

In the 1870 census for this same part of Jennings Township, here is the image. Near another Hance family we find the previously mentioned record of the Loy household that I am proposing is actually a mix of two households.

1870 United States Federal Census for Richard Hance												
Ohio > Van Wert > Jennings												
16	Dwell	Famil	Name	Age	Sex	Race	Occupation	Real	Personal	Birthplace	Father Fc	Mother Fc
17	No.	No.						Estate	Estate			Birth
18												Mont
18			Benjamin	10	M	W				Ohio		
19			Barbara	5	F	W				Ohio		
20			Mary T	3	F	W				Ohio		
21	88	88	Houston Commod	32	M	W	Farmer	1300	624	Keese Darmstadt	1	1
22			Elizabeth	35	F	W	Keeping House			Keese Darmstadt	1	1
23	89	89	Baird James	37	M	W	Farmer	1000	120	Pennsylvania		
24			Elizabeth	36	F	W	Keeping House			Pennsylvania		
25			James W	18	M	W				Ohio		
26	90	90	Hance Richard	46	M	W	Farmer	3000	370	Kentucky		
27			Margaret	43	F	W	Keeping House			Kentucky		
28			Wilkinson	15	M	W				Ohio		
29			Ann A	13	F	W				Ohio		
30			Austin	9	M	W				Ohio		
31			Edward	6	M	W				Ohio		
32			John	4	M	W				Ohio		
33	91	91	Loy John	30	M	W	Farmer	1000	185	Baden	1	1
34			Catharine	60	F	W	Keeping House			Keese Darmstadt	1	1
35			Mary	16	F	W				Ohio	1	1
36			Jetta	13	F	W				Ohio	1	1
37			Lizzie	12	F	W				Ohio	1	1
38			Sophia	11	F	W				Ohio	1	1
39			Samuel	11	M	W				Ohio	1	1
40			Sarah	7	F	W				Ohio	1	1

Mary M. is on the next page.

# Johann Georg Lay a.k.a. John Loy

Page No. 14 } ~~and~~ Inquiries numbered 7, 16, and 17 are not to be asked in respect to infants. Inquiries numbered 11, 12, 15, 16, 17, 19, and 20 are to merely by an affirmative mark, as /.

SCHEDULE I.—Inhabitants in Farmington Township, in the County of Van Wert of Ohio, enumerated by me on the 10 day of August, 1870.

Post Office: Spencer Ohio Geo W Alexander

1	2	3	DESCRIPTION.			VALUE OF REAL ESTATE OWNED.		10	PARENTAGE.		13	14	EDUCATION.		17		
			4	5	6	7	8		9	11			12	15		16	
Dwellings-houses, numbered in the order of visitation.		The name of every person whose place of abode on the first day of June, 1870, was in this family.	Age at last birth-day. If under 1 year, give months in fractions, like 1/2.	Sex.—Male (M.), Female (F.)	Color.—White (W.), Black (B.), American (A.), Chinese (C), Indian (I).	Profession, Occupation, or Trade of each person, male or female.	Value of Real Estate.	Value of Personal Estate.	Place of Birth, naming State or Territory of U. S.; or the Country, if of foreign birth.	Father of foreign birth.	Mother of foreign birth.	If born within the year, state month (Jan., Feb., &c.)	If married within the year, state month (Jan., Feb., &c.)	Attended school within the year.	Cannot read.	Cannot write.	Whether blind or
<u>92</u>	<u>92</u>	<u>Hance R L</u>	<u>60</u>	<u>M</u>	<u>W</u>	<u>Farmer</u>	<u>3000</u>	<u>220</u>	<u>Kentucky</u>								

So, it certainly appears possible that some time after the birth of Mary M. Louth in 1864, the marriage of Andrew and Catherine (Klinger) Louth ended. Catherine then married John in 1865, and they moved in to the farm near other Louth families.

# Johann Georg Lay a.k.a. John Loy

## The 1880 Federal Census

As a tribute to John's mobility, I now find a John Loy alone in Lima, Allen Co., OH, as a carpenter. His birth information is wrong, but this may be him. He is a boarder at a hotel.

Page No. 33<sup>rd</sup>  
Supervisor's Dist. No. 1<sup>st</sup>  
Enumeration Dist. No. 227

Received July 30, 1880. A.

Note A.—The Census Year begins June 1, 1879, and ends May 31, 1880.  
Note B.—All persons will be included in the Enumeration who were living on the 1st day of June, 1880. No others will. Children BORN SINCE June 1, 1880, will be OMITTED. Members of Families who have DIED SINCE June 1, 1880, will be INCLUDED.  
Note C.—Questions Nos. 13, 14, 22 and 23 are not to be asked in respect to persons under 10 years of age.

SCHEDULE 1.—Inhabitants in Second Ward Lima, in the County of Allen, State of Ohio  
enumerated by me on the 1<sup>st</sup> day of June, 1880.  
E. M. Schuyler  
Enumerator.

Loy John	WM 52	Boarder 1	carpenter 1	Ohio	Ohio	Ohio
----------	-------	-----------	-------------	------	------	------

(source: "United States Census, 1880," database with images, *FamilySearch*

(<https://familysearch.org/ark:/61903/1:1:MZ17-NBB> : 11 September 2017), John Loy in household of William Hohl, Lima, Allen, Ohio, United States; citing enumeration district ED 227, sheet 533A, NARA microfilm publication T9 (Washington D.C.: National Archives and Records Administration, n.d.), roll 0990; FHL microfilm 1,254,990. )

By this time it makes sense that he would be alone. All children except Sam and Sarah are married, and Sam and Sarah are fending for themselves – Sarah is working in Delphos for sure, but I have not found Sam. (Finding Sam in 1880 is another research goal.)

# Johann Georg Lay a.k.a. John Loy

But, what happened to Catherine? Here is a possible answer, also from the 1880 census. (She is divorced in Van Wert and with daughters Catherine Louth, Linda Louth and Sophia Louth, but she maintains the Loy surname.)

Page No. 14  
 Supervisor's Dist. No. One  
 Enumeration Dist. No. 151

Note A.—The Census Year begins June 1, 1879, and ends May 31, 1880.  
 Note B.—All persons will be included in the Enumeration who were living on the 1st day of June, 1880. No others will. Children BORN SINCE June 1, 1880, will be OMITTED. Members of Families who have DIED SINCE June 1, 1880, will be INCLUDED.  
 Note C.—Questions Nos. 13, 14, 22 and 23 are not to be asked in respect to persons under 10 years of age.

SCHEDULE I.—Inhabitants in Fourth Ward Van Wert, in the County of Van Wert, State of Ohio  
 enumerated by me on the fifth day of June, 1880.  
*Charles W. Scripture*  
 Enumerator

In Ohio	Name of Person	Sex	Age	Color	Personal Description	Relationship of each person to the head of this family—whether wife, son, daughter, servant, boarder, or other.	Census Questions	Profession, Occupation or Trade of each person, male or female.	In the year, for the day of the Enumeration, was any sick, or temporarily disabled, or unable to work, or attended to contrary sickness or other?	Health				Education		Native			
										15	16	17	18	19	20	21	22	23	24
	<u>Loy Catherine</u>	<u>W</u>	<u>23</u>	<u>33</u>	<u>W</u>	<u>Daughter</u>	<u>1</u>	<u>Keeping House</u>	<u>1</u>	<u>1</u>	<u>1</u>	<u>1</u>	<u>1</u>	<u>1</u>	<u>1</u>	<u>1</u>	<u>1</u>	<u>Ohio</u>	<u>Van Wert</u>
	<u>Loy Catherine</u>	<u>W</u>	<u>12</u>	<u>21</u>	<u>W</u>	<u>Daughter</u>	<u>1</u>	<u>Keeping House</u>	<u>1</u>	<u>1</u>	<u>1</u>	<u>1</u>	<u>1</u>	<u>1</u>	<u>1</u>	<u>1</u>	<u>1</u>	<u>Ohio</u>	<u>Van Wert</u>
	<u>Loy Sophia</u>	<u>W</u>	<u>20</u>	<u>20</u>	<u>W</u>	<u>Daughter</u>	<u>1</u>	<u>Keeping House</u>	<u>1</u>	<u>1</u>	<u>1</u>	<u>1</u>	<u>1</u>	<u>1</u>	<u>1</u>	<u>1</u>	<u>1</u>	<u>Ohio</u>	<u>Van Wert</u>
	<u>Loy Linda</u>	<u>W</u>	<u>17</u>	<u>17</u>	<u>W</u>	<u>Daughter</u>	<u>1</u>	<u>Keeping House</u>	<u>1</u>	<u>1</u>	<u>1</u>	<u>1</u>	<u>1</u>	<u>1</u>	<u>1</u>	<u>1</u>	<u>1</u>	<u>Ohio</u>	<u>Van Wert</u>
	<u>Loy Johann</u>	<u>W</u>	<u>33</u>	<u>33</u>	<u>W</u>	<u>Head of Family</u>	<u>1</u>	<u>Wagon Manufacture</u>	<u>1</u>	<u>1</u>	<u>1</u>	<u>1</u>	<u>1</u>	<u>1</u>	<u>1</u>	<u>1</u>	<u>1</u>	<u>Ohio</u>	<u>Germany</u>

("United States Census, 1880," database with images, FamilySearch (<https://familysearch.org/ark:/61903/1:1:M83Q-Y35 : 15 July 2017>), Catharine Loy, Van Wert, Van Wert, Ohio, United States; citing enumeration district ED 151, sheet 362B, NARA microfilm publication T9 (Washington D.C.: National Archives and Records Administration, n.d.), roll 1073; FHL microfilm 1,255,073. )

If this is the right person, then the birth date for the divorced Catherine is 1827, not 1810 as would be implied by the 1870 census (noted earlier). Also, the names of the children are not quite the same.

In 1880 we have . . .

- Catherine, age 21
- Sophia, age 20
- Linda, age 17

as opposed to the following in 1860 . . .

# Johann Georg Lay a.k.a. John Loy

- Lizzie, age 12
- Sophia, age 11
- Mary M. 6.

The age differences of the children are believable. Was Catherine (12) in 1860 also known as Lizzie? (I can't find any evidence of this.) Was Mary M. (6) in 1860 known as Linda? For this there are some opinions that she is the same person that married Elias Hinton in Van Wert in 1887 and moved to IN. These opinions list her as Linda Mary Louth or Mary Malinda Louth.

So, John Loy's life in the 1870s and 1880s might have been pretty complicated. Perhaps with patience and perseverance, reality will emerge.

# Johann Georg Lay a.k.a. John Loy

## Death



John died in 1892 at the home of his youngest daughter, Sarah, in Delphos. He is buried not far from there.

Here is the findagrave entry.

(<https://www.findagrave.com> : accessed 03 July 2018), memorial page for John Loy (1819–17 Apr 1892), Find A Grave Memorial no. 81576578, citing Walnut Grove Cemetery, Delphos, Allen County, Ohio, USA ; Maintained by Jim Baxter Jr (contributor 47172577) .

An obituary follows below.

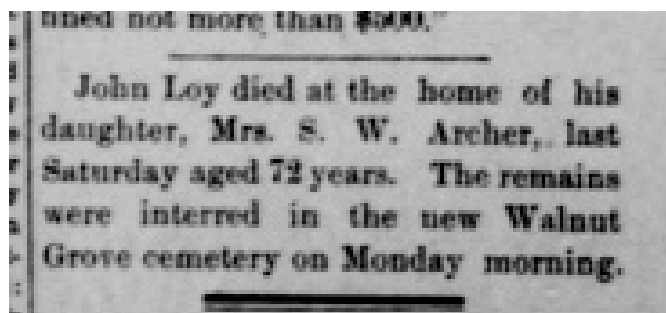

# Johann Georg Lay a.k.a. John Loy

## Families of children

Here is some cursory information about the descendants of John Loy. First, the children of John's marriage to Sophia as well as the subsequent generation.

<b>1. Loy, John (b. 1820-08-15 Baden - d. 1892-04-17 Delphos (OH))</b>
sp. Snyder, Susannah (b. 1832 Pennsylvania - ), m. 1857-03-28 Marion (OH)
sp. Kaelber, Sophia (b. 1820-11-01 - d. 1853-05-16 Baden), m. 1848-02-20 Baden
<b>2. Loy, John Edwin (b. 1848-12-29 Baden - d. 1902 )</b>
sp. Parker, Catherine A. (b. 1859-03-22 - d. 1899-08-17 ), m. 1872-07-27
3. Loy, Mary Elizabeth (b. 1873-05-29 - d. 1873-05-30 )
3. Loy, William Edwin (b. 1874-05-28 - d. 1874-05-29 )
3. Loy, Ella Rose (b. 1875-05-08 Cridersville (OH) - d. 1960-07-17 Delphos (OH))
3. Loy, Hester Anne (b. 1877-04-25 - d. 1962-03-19 Delphos (OH))
3. Loy, Sarah Elizabeth (b. 1879-12-18 Delphos (OH) - d. 1944-12-00 )
3. Loy, Daniel Benjamin (b. 1884-09-18 - d. 1892-10-20 Cridersville (OH))
3. Loy, John B. (b. 1887-02-14 - d. 1935-06-26 )
3. Loy, Emma May (b. 1891-04-06 - d. 1956-12-30 )
3. Loy, Clarence Nathaniel (b. 1896-01-08 - d. 1967-11-14 New York)
<b>2. Loy, Catherine L. (b. 1851-09-26 Baden - d. 1930-05-14 Delphos (OH))</b>
sp. Stopher, William (b. 1843-05-13 - d. 1915-09-14), m. 1868-02-01
3. Stopher, Anna N. (b. 1872-04-08 Ohio - d. 1949-09-14 Indiana)
3. Stopher, William H. (b. 1881-04-30 Delphos (OH) - d. 1949-09-20 Lima (OH))
3. Stopher, Mary H. (b. 1883-08-05 Delphos (OH) - d. 1978-01-13 Lima (OH))
3. Stopher, Bertha C. (b. 1890-09-20 Delphos (OH) - d. 1974-12-26 Delphos (OH))
3. Stopher, Margaret H. (b. 1897-05-11 Delphos (OH) - d. 1979-08-13 Maumee (OH))
<b>2. Loy, Mary (b. 1853 Ohio - d. 1918-02-09 Chicago)</b>
sp. Kopp, Francis (b. 1858-02-11 Delphos (OH) - d. 1904-09-19 Chicago), m. 1878-02-12
3. Kopp, William J. (b. 1882 - d. 1959)
3. Kopp, Charles (b. 1883 - d. 1963)
3. Kopp, Albert Joseph (b. 1888-03-04 - d. 1931-09-09 Chicago)
3. Kopp, Ferdinand John (b. 1889 - d. 1960)
3. Kopp, Stanley John (b. 1893-04-30 - d. 1976-05-07 )

# Johann Georg Lay a.k.a. John Loy

Next, here is a summary of the children of John and Susannah and one subsequent generation.

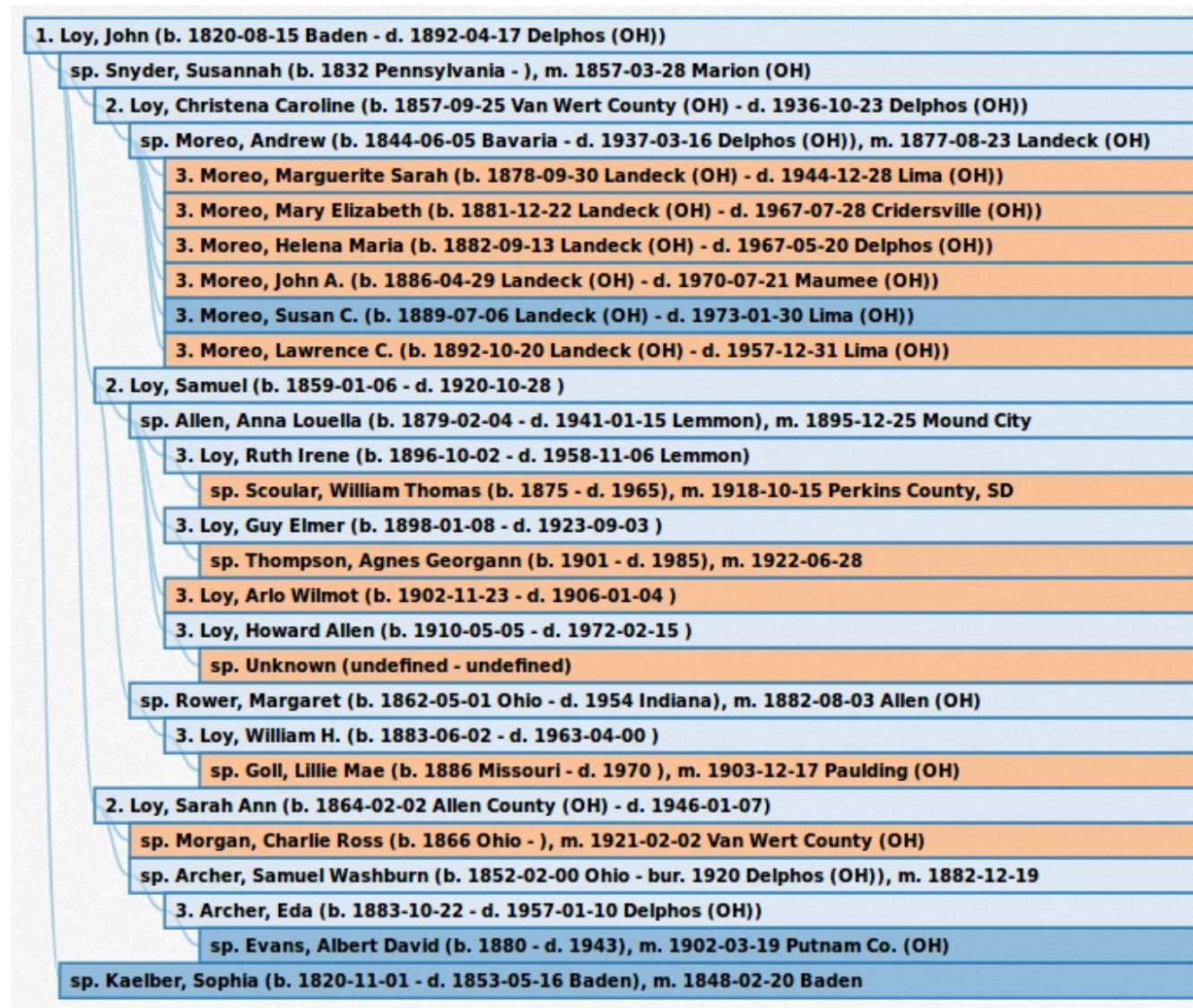



# Johann Georg Lay a.k.a. John Loy

## Summary

So, after wading through the information presented above, I hope that you can see why I believe that there is a series of events that can explain the existing records. The time-line that follows can then be used as a guide to the events in the approximately 72 years of John Loy's life.

year	note	event
1820		birth near Pforzheim, Baden
1848		birth of son John
		marriage to Sophia Kaelber
1851		birth of daughter Catherine
1852	est.	immigration to US
1853		birth of daughter Mary
	est.	termination of marriage to Sophia
1857		birth of daughter Christena
		marriage to Susannah Snyder
1858		naturalization
1859		birth of son Sam
1860		residence in Marion Co., OH
1864		birth of daughter Sarah
	est.	termination of marriage to Susannah
1865		marriage to Catherine Klinger Lout
1870		residence in Jennings Twp, Van Wert Co., OH
		residence in town of Van Wert, OH
1875	est.	termination of marriage to Catherine
1880		residence in Allen Co., OH
1887		death of Catherine Klinger
1892		burial near Delphos, OH
		death in Delphos, OH

# Johann Georg Lay a.k.a. John Loy

Here is a map of part of Baden that shows the area where John lived. This map is from the Meyers Gazetteer for the period between about 1871 and 1919. The red pin shows roughly where John and his first wife, Sophia, were married. The births of their first two children, John and Catherine, were both recorded in Würm. Sophia was from Eutingen.



# Johann Georg Lay a.k.a. John Loy

Here is a map of Ohio that shows locations where John lived. This is a map from 1860. The areas of Marion, Van Wert, and Allen Counties where John was present are indicated.

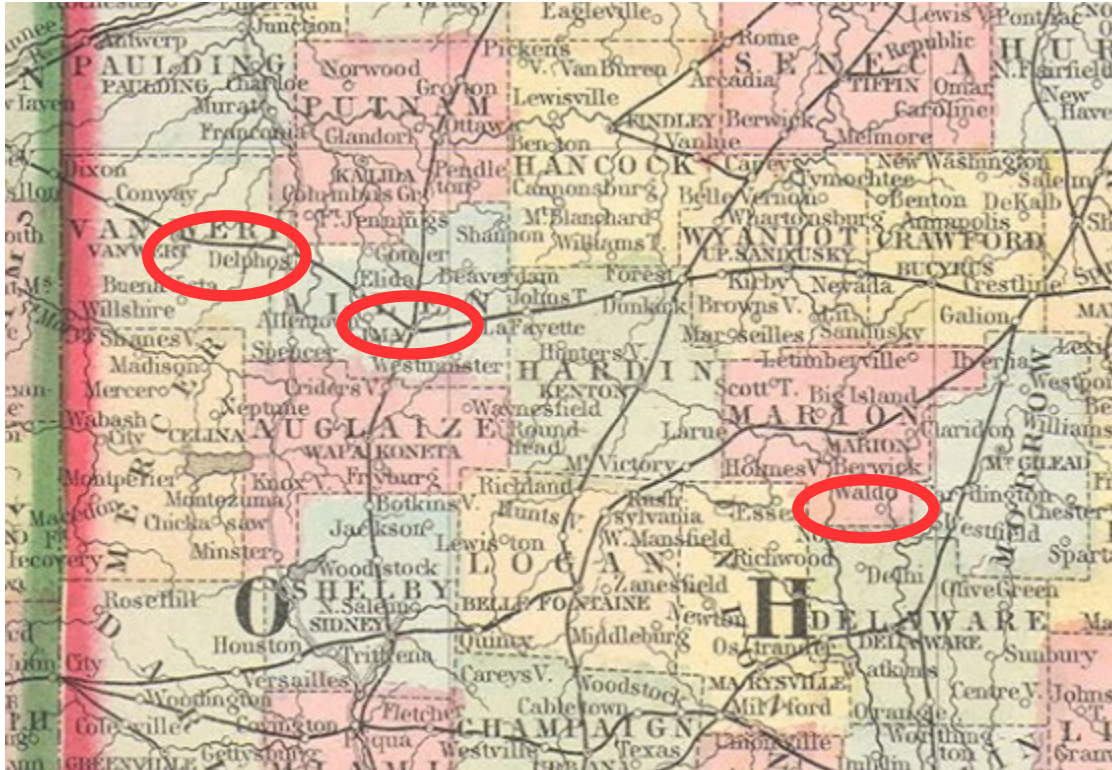

# Johann Georg Lay a.k.a. John Loy

## Future Research

Confirm/refute speculation about the identity of a third wife.

Determine what happened to second wife, Susannah.

Find out the details of travel to USA.

Explore the history of people from Baden in Marion County, OH.

Determine what happened to first wife, Sophia. - Resolve the sequence events in the early 1850s to confirm correct dates for Mary's birth and Sophia's death. This should confirm/refute to assumption that Mary is Sophia's daughter.

A research note: If you do research on Loy families, note that, in addition to the families described in this document, there are other families with similar names that may be confusing. Here are some that I have encountered.

- There was a John L. Loy born in TN and moved to IN. See for example - "United States Census, 1850," database with images, FamilySearch (<https://familysearch.org/ark:/61903/1:1:MHV3-W96> : 12 April 2016), John L Loy in household of Henry Loy, White River, Randolph, Indiana, United States; citing family 488, NARA microfilm publication M432 (Washington, D.C.: National Archives and Records Administration, n.d.).
- There was a John W. Loy that was born in OH and moved to KS. See for example - "United States Census, 1880," database with images, FamilySearch (<https://familysearch.org/ark:/61903/1:1:MFPK-5JK> : 7 September 2017), John W Loy, Augusta, Butler, Kansas, United States; citing enumeration district ED 156, sheet 89B, NARA microfilm publication T9 (Washington D.C.: National Archives and Records Administration, n.d.), roll 0375; FHL microfilm 1,254,375.
- Preble Co., OH: There are Loys in Preble Co., including on Sam F. Loy. This family is all from OH and predates "our" John and Sam Loy. See for example - "United States Census, 1860", database with images, FamilySearch (<https://familysearch.org/ark:/61903/1:1:MCLZ-N3Z> : 13 December 2017), Samuel F Loy in entry for Greenbury Loy, 1860. This Sam moved to IN. This family generated a John Loy as well as a Sam Loy. See for example - "United States Census, 1850," database with images, FamilySearch (<https://familysearch.org/ark:/61903/1:1:MX7M-2PG> : 12 April 2016), John Loy in household of Greanbury Loy, Twin, Preble, Ohio, United States; citing family 776, NARA microfilm publication M432 (Washington, D.C.: National

# Johann Georg Lay a.k.a. John Loy

Archives and Records Administration, n.d.).

- Hocking Co., OH: There was a Sam Loy born in Hocking Co. within about a year of “our” Sam. See for example - "Ohio Deaths, 1908-1953," database with images, FamilySearch (<https://familysearch.org/ark:/61903/1:1:X6WT-WZK> : 8 March 2018), Samuel Loy, 09 Nov 1935; citing Greenfield Township, Fairfield, Ohio, reference fn 69924; FHL microfilm 2,022,569.
- Faulk Co., SD: There is a Sam Loy that settled in Faulk Co. and lived there while “our” Sam Loy was in Campbell Co., SD. This other Sam Loy actually originated in PA, then KS. I can find no reason to suspect relatedness. See for example - "United States Census, 1880," database with images, FamilySearch (<https://familysearch.org/ark:/61903/1:1:MFPN-5NH> : 12 August 2017), Samuel Loy, Atchison City, Atchison, Kansas, United States; citing enumeration district ED 3, sheet 297D, NARA microfilm publication T9 (Washington D.C.: National Archives and Records Administration, n.d.), roll 0372; FHL microfilm 1,254,372. See also - "United States Census, 1900," database with images, FamilySearch (<https://familysearch.org/ark:/61903/1:1:MMRQ-6ZR> : accessed 5 July 2018), Samuel Loy, Orient, Arcade, Lafoon & Faulkton Township Faulkton city Ward 1-3, Faulk, South Dakota, United States; citing enumeration district (ED) 367, sheet 10A, family 184, NARA microfilm publication T623 (Washington, D.C.: National Archives and Records Administration, 1972.); FHL microfilm 1,241,549.
- There is another group of Lay/Loy people, who seem to trace to a man (Georg Jacob Loy b. 1801) from Baden, who immigrated in about 1854. This man and his descendants are tied back in Baden to our Johann Georg Lay. (<https://www.familysearch.org/tree/person/details/K26V-2W8> and <https://gw.geneanet.org/tereni?n=layh+loy&oc=&p=jacob> ) This group of people lived in Crawford Co., OH, just east of Lima. Following this lead brought me to a person (sputterfuss94) on ancestry.com with whom mother and I share a small amount of DNA. This amount is consistent (if it is not noise) with a common ancestor in the mid 18<sup>th</sup> century. Here is another link of possible use. <https://www.ancestry.com/account/profile/00d71fab-0006-0000-0000-000000000000> This connection could be explored further.





# Campbell County Convergence

## Table of Contents

Overview.....	2
Land Patent Information.....	3
Sam Loy – in section 24.....	4
Allen Patents - in sections 1, 12, and 13.....	4
John E. Robbins – in section 13.....	5
Charles Stuart – in section 14.....	5
Myron Kimmy – in section 11.....	6
Hatch Patents – in sections 1, 2, 11, 12.....	6
Founders: The Robbins/Warner and Allen/Robbins Families.....	7
Relationships of Homesteaders to Lucia Robbins Allen.....	9
Family Details.....	11
Lucia Robbins and James H. Allen.....	11
An Early Picture of Lucia Robbins.....	11
A Later Picture of Lucia Robbins Allen.....	11
Background about James H. Allen.....	12
Obituary for James H. Allen.....	12
Obituary for Lucia Robbins.....	12
John E. Robbins (brother).....	13
Charles Stuart and Martha Naomi Robbins (sister).....	14
Picture of Martha Naomi Robbins.....	14
Charles Stuart family photo.....	14
Columbus Hatch and Louisa Esther Robbins (sister).....	15
Picture of Columbus Hatch and Louisa Esther Robbins.....	15
Harry J. Allen (son) and Mattie Hankins.....	16
Myron Kimmy and Mary Electa Allen (daughter).....	17
Myron_Kimmy_family picture.....	17
Myron_Kimmy_family picture in Canada.....	18
Albert R. Allen (son) and Mary Hanes/Kightlinger.....	19
Sam Loy and Anna Louella Allen (daughter).....	20
A Robbins Family Bible.....	24
Related Census Information.....	26

# Campbell County Convergence

## Overview

Sam Loy and Anna Allen encountered each other in Campbell County, SD. I suspect that Sam came to the area from Ohio in about 1888 or perhaps slightly earlier. Sam may have traveled there alone from OH– I believe just after separation from his first wife in 1885-1886. Anna and her family moved to the area perhaps somewhat sooner than that. Anna was part of a group of related families that moved from Crawford Co., PA.

To help understand the encounter, this note starts by exploring land patent information for the township (Fairview) where Sam and Anna lived prior to their marriage in 1895. Inter-relationships among certain of the people who settled in Fairview Township are presented in the context of these patents.

Some (much) of this information was earlier presented by John Allen in a publication entitled “A Treasure – The Family of James H. Allen.” Here I focus on just one aspect of the lives (i.e.,locations) of the some of the people that John Allen discussed in more detail. Here is what he had to say about the move of Anna’s family to SD.

In 1885 the Dakota Territory was open for homesteading. With the exception of son John, the whole family moved to what is now Campbell County, South Dakota. Cousins Frank and Ira Hatch had discovered the area when they were returning from the "Gold Fields" of Colorado. Mound City was 100 miles from the end of the railroad at Aberdeen. The move to South Dakota and the early years are well described by daughter Anna Loy.



# Campbell County Convergence

## Land Patent Information

The picture that follows shows select homestead “sites” in part of Fairview Township in Campbell Co., SD, based on BLM information for T125N R77W (5<sup>th</sup> principal meridian). Surnames mentioned are Allen, Hatch, Kimmy, Stuart, Robbins, and Loy. Except for Loy, all of these names represent families that moved from the vicinity of Meadville, Crawford Co., PA, in the last 15 years of the 19<sup>th</sup> century. At this time South Dakota had just become a state, and public lands were made available for settlement. In general, Campbell County was settled by German-Russians, Norwegians, and an assortment of others. This group of homesteaders is part of “the others.”

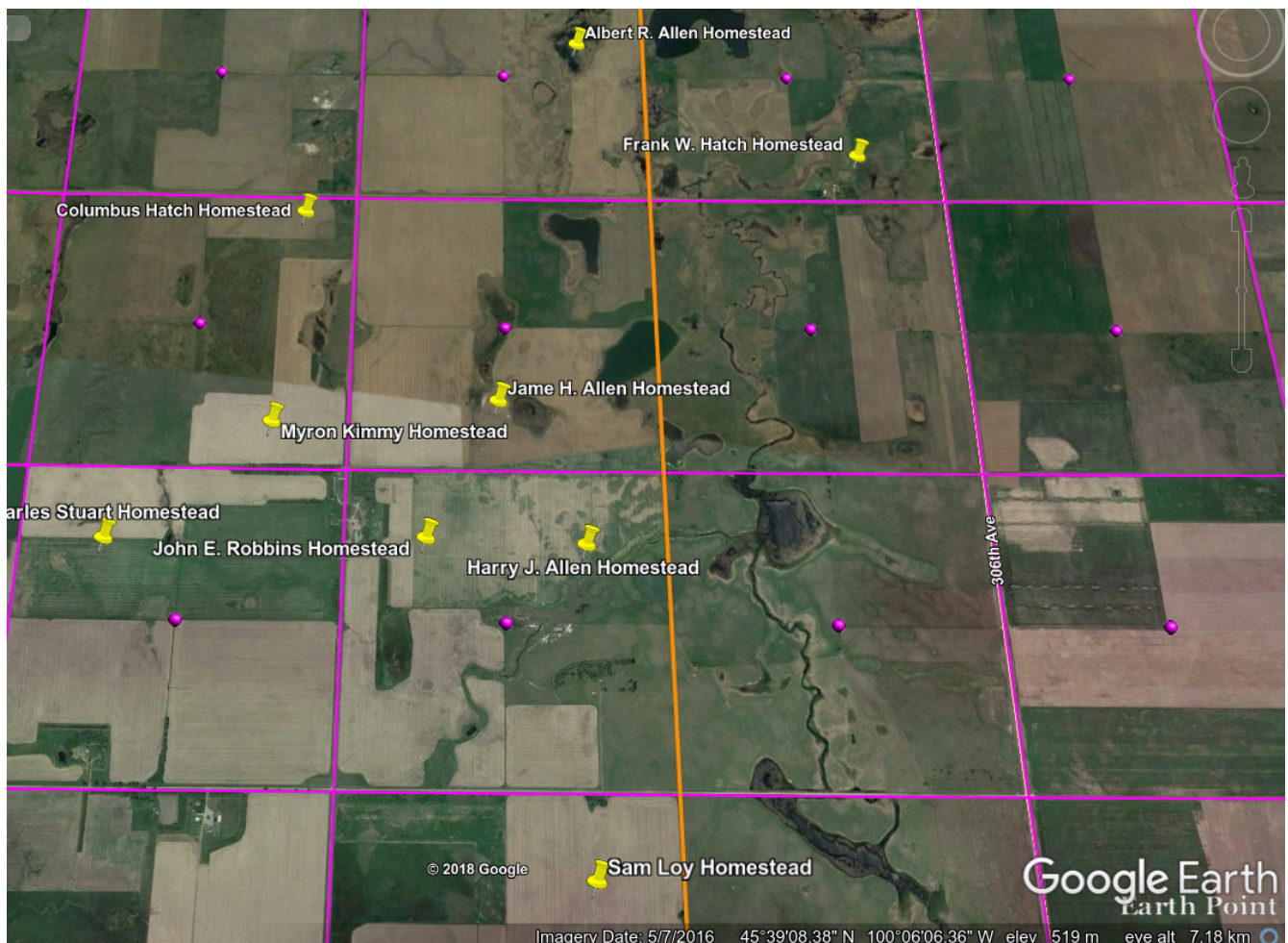



Following are slightly more detailed descriptions of the land patents shown in the picture.

# Campbell County Convergence

## Sam Loy – in section 24













<https://glorerecords.blm.gov/details/patent/default.aspx?>

[accession=SD0270\\_.417&docClass=STA&sid=p1e2nuwh.mwj#patentDetailsTabIndex=0](https://glorerecords.blm.gov/details/patent/default.aspx?accession=SD0270_.417&docClass=STA&sid=p1e2nuwh.mwj#patentDetailsTabIndex=0)

Image	Accession	Names ↑	Date	Doc #	State	Meridian	Twp - Rng	Aliquots	Sec. #	County
	<a href="#">SD0270_.417</a>	 LOY, SAMUEL	10/13/1893	2928	SD	5th PM	125N - 077W	NE¼	24	Campbell

## Allen Patents - in sections 1, 12, and 13

Five patents are shown for Allens in Fairview Township. See <https://glorerecords.blm.gov/results/default.aspx?searchCriteria=type=patent|st=SD|cty=021|ln=allen|sp=true|sw=true|sadv=false>.



Image	Accession	Names ↑	Date	Doc #	State	Meridian	Twp - Rng	Aliquots	Sec. #	County
	<a href="#">SD0250_.027</a>	 ALLEN, ALBERT R	12/11/1891	2032	SD	5th PM	125N - 077W	Lot/Trct 1	1	Campbell
							125N - 077W	Lot/Trct 2	1	Campbell
							125N - 077W	S½NE¼	1	Campbell
---	<a href="#">SDMTAA 063365</a>	 ALLEN, ALBERT R	2/14/1900	2070	SD	5th PM	125N - 077W	S½NW¼	1	Campbell
							125N - 077W	Lot/Trct 3	1	Campbell
							125N - 077W	Lot/Trct 4	1	Campbell
							125N - 077W	Lot/Trct 4	1	Campbell
	<a href="#">SD0260_.010</a>	 ALLEN, HARRY J	11/15/1893	2062	SD	5th PM	125N - 077W	NE¼	13	Campbell
	<a href="#">SD0260_.417</a>	 ALLEN, JACOB	3/23/1901	4646	SD	5th PM	128N - 076W	NW¼	15	Campbell
	<a href="#">TC-0166-142</a>	 ALLEN, JAMES H	5/21/1895	1038	SD	5th PM	125N - 077W	SW¼	12	Campbell
---	<a href="#">SDMTAA 063340</a>	 ALLEN, JAMES H	5/21/1895	1038	SD	5th PM	125N - 077W	SW¼	12	Campbell
								<a href="#">SD0250_.026</a>	 ALLEN, LUCIA E,  ALLEN, JAMES H	12/11/1891

All but one of these are shown in the picture above. The one left out is for Jacob Allen. It was taken out much later, as he was the son of Albert R. Allen.

# Campbell County Convergence

## John E. Robbins – in section 13

Three patents are shown for people named Robbins. - <https://glorerecords.blm.gov/results/default.aspx?searchCriteria=type=patent|st=SD|cty=021|ln=robbins|sp=true|sw=true|sadv=false>

Image	Accession	Names ↑	Date	Doc #	State	Meridian	Twp - Rng	Aliquots	Sec. #	County
	<a href="#">568273</a>	[P] ROBBINS, HARRY	2/20/1917	012634	SD	5th PM	128N - 080W	SE¼NE¼	1	Campbell
							128N - 080W	NE¼SE¼	1	Campbell
							128N - 080W	Lot/Trct 1	1	Campbell
	<a href="#">1030646</a>	[P] ROBBINS, HARRY EUGENE	9/7/1929	015901	SD	5th PM	128N - 080W	Lot/Trct 3	11	Campbell
							128N - 080W	Lot/Trct 4	11	Campbell
	<a href="#">SD0270 .478</a>	[P] ROBBINS, JOHN E	1/8/1894	2991	SD	5th PM	125N - 077W	NW¼	13	Campbell

For now, I am ignoring the patents for Harry Eugene Robbins. His patents are much later than the others being considered here. However, his line may trace back to Robbins people in colonial CT, and so he may be distantly related to the other Robbins people, whose histories are discussed here. This might be an interesting line of research for the future.

The patent for John E. Robbins, however, is of interest as he is John Edwin Robbins III, the brother of Lucia.

## Charles Stuart – in section 14

Charles has one patent where his family lives. He is related to Lucia by marriage to her sister, Martha. - <https://glorerecords.blm.gov/results/default.aspx?searchCriteria=type=patent|st=SD|cty=021|ln=stuart|sp=true|sw=true|sadv=false>

Image	Accession	Names ↑	Date	Doc #	State	Meridian	Twp - Rng	Aliquots	Sec. #	County
	<a href="#">SD0250 .029</a>	[P] STUART, CHARLES	12/11/1891	2035	SD	5th PM	125N - 077W	NW¼	14	Campbell

# Campbell County Convergence

## Myron Kimmy – in section 11







One patent - <https://glorerecords.blm.gov/results/default.aspx?searchCriteria=type=patent|st=SD|cty=021|ln=kimmy|sp=true|sw=true|sadv=false>

Image	Accession	Names ↑	Date	Doc #	State	Meridian	Twp - Rng	Aliquots	Sec. #	County
	<a href="#">SD0250 .031</a>	KIMMY, MYRON	12/11/1891	2037	SD	5th PM	125N - 077W	SE¼NE¼	11	Campbell
							125N - 077W	E¼SE¼	11	Campbell
							125N - 077W	SW¼SE¼	11	Campbell

Myron is married to Lucia's sister, Mary.

## Hatch Patents – in sections 1, 2, 11, 12

Five patents are shown. - <https://glorerecords.blm.gov/results/default.aspx?searchCriteria=type=patent|st=SD|cty=021|ln=hatch|sp=true|sw=true|sadv=false>

Image	Accession	Names ↑	Date	Doc #	State	Meridian	Twp - Rng	Aliquots	Sec. #	County
	<a href="#">SD0240 .331</a>	HATCH, COLUMBUS	2/3/1891	1774	SD	5th PM	125N - 077W	S½SE¼	2	Campbell
							125N - 077W	N½NE¼	11	Campbell
	<a href="#">SD0240 .487</a>	HATCH, FRANK W	10/16/1891	2001	SD	5th PM	125N - 077W	SE¼	1	Campbell
	<a href="#">SD0190 .138</a>	HATCH, IRA A	4/18/1895	10622	SD	5th PM	125N - 077W	NW¼	12	Campbell
	<a href="#">SD0240 .215</a>	HATCH, IRA A	10/28/1890	1761	SD	5th PM	125N - 077W	SW¼	1	Campbell
	<a href="#">SD0280 .118</a>	HATCH, VINONA E. AUSTIN, VINONA E	7/2/1894	3123	SD	5th PM	125N - 076W	Lot/Trct 3	5	Campbell
							125N - 076W	Lot/Trct 4	5	Campbell
							125N - 076W	S½NW¼	5	Campbell
	<a href="#">SD0720 .334</a>	HATCH, VIRGIL W	4/15/1902	4951	SD	5th PM	125N - 077W	N½SE¼	2	Campbell

In the picture above, only two are pictured – those for Columbus and Frank W. Hatch. Columbus was married to Lucia's sister, Ester/Esther. By way of explanation, Frank, Ira, and Virgil Hatch are son's of Columbus. Vinona is Virgil's wife. (Her maiden name was Austin.)

# Campbell County Convergence

## Founders: The Robbins/Warner and Allen/Robbins Families

The homesteads mentioned above can be understood in the context of just two families. - The family of John Edwin Robbins Jr. / Electa Warner and the family of their daughter Lucia Elila Robbins and her husband James Henry Allen.

Here is a family group sheet for the Robbins / Warner family.

Family Group Report		
<b>Husband: Robbins, John Edwin Junior</b>		
Birth	1801-06-01	Connecticut
Death	1877-03-13	Blooming Valley, Crawford, Pennsylvania
Father	Robbins, John Edwin	
Mother	Chandler, Elizabeth Corning	
<b>Wife: Warner, Electa</b>		
Birth	1807-07-05	Parma, Chemung, New York, Chemung, New York
Death	Find A Grave Memorial# 152012769	
	1863-08-14	Blooming Valley, Crawford, Pennsylvania
Father	Warner, Richard	
Mother	Hickox, Polly	
<b>Children</b>		
<b>1F</b>	<b>Robbins, Louisa Esther</b>	
	Birth	1829-12-02 Oakland, Livingston, New York
	Death	1922-12-06 Blooming Valley, Crawford, Pennsylvania
	Spouse	Hatch, Columbus
<b>2M</b>	<b>Robbins, John Edwin III</b>	
	Birth	1831-03-06 Oakland, Livingston, New York
	Death	1901-04-09 Albion PA, Erie, Pennsylvania
<b>3F</b>	<b>Robbins, Sophia Electa</b>	
	Birth	1832-07-29 Oakland, Livingston, New York
	Death	1871-01-01 Blooming Valley, Crawford, Pennsylvania
<b>4F</b>	<b>Robbins, Lucia Elila</b>	
	Birth	1834-10-17 Oakland, Livingston, New York
	Death	1910-10-20 Canby, Clackamas, Oregon
	Spouse	Allen, James Henry
	Marriage	1854-05-01 Crawford, Pennsylvania
<b>5M</b>	<b>Robbins, Calvin</b>	
	Birth	1837
	Death	1839
<b>6F</b>	<b>Robbins, Mary Elizabeth</b>	
	Birth	1840-01-06 Crawford, Pennsylvania
	Death	1877-05-11 Crawford, Pennsylvania
<b>7F</b>	<b>Robbins, Mariah</b>	
	Birth	1844-01-02 Crawford, Pennsylvania
	Death	1926-10-14 Summit County, OH, Ohio
<b>8F</b>	<b>Robbins, Martha Naomi</b>	
	Birth	1845-07-19 New York
	Death	
<b>9F</b>	<b>Robbins, Helen Josephine</b>	
	Birth	1847-04-14 Richmond, Pennsylvania, USA
	Death	1883-04-15 Townville, PA, USA
	Spouse	Frost, Richard Chambers

# Campbell County Convergence

Then there is a family group sheet for the Allen / Robbins family.

Family Group Report		
<b>Husband: Allen, James Henry</b>		
Birth	1831-11-29	Brant, NY, Erie County, NY, New York
Death	1888-11-29	Mound City, Campbell, South Dakota, US
Father	Allen, Elisha	
Mother	Benedict, Electa Mercy	
<b>Wife: Robbins, Lucia Elila</b>		
Birth	1834-10-17	Oakland, Livingston, New York
Death	1910-10-20	Canby, Clackamas, Oregon
Father	Robbins, John Edwin Junior	
Mother	Warner, Electa	
<b>Children</b>		
<b>1F</b>	<b>Allen, Ellen Imogene</b>	
	Birth	1855-10-10 Titusville, Pennsylvania
	Death	1858-08-28 Crawford, Pennsylvania
<b>2F</b>	<b>Allen, Louesa Josephine</b>	
	Birth	1857-11-17 Titusville, Pennsylvania
	Death	1858-08-31 Crawford, Pennsylvania
<b>3F</b>	<b>Allen, Mary Electa</b>	
	Birth	1858-03-23 Titusville, Pennsylvania
	Death	1926-12-07 Alberta, Canada
	Spouse	Kimmy, Myron
	Marriage	1883-11-08 Pennsylvania
<b>4M</b>	<b>Allen, John Elizia</b>	
	Birth	1860-08-02 Titusville, Pennsylvania
	Death	1937-03-07 Meadville, PA
	Spouse	McFadden, Emma
<b>5M</b>	<b>Allen, George Edwin</b>	
	Birth	1862-04-07 Titusville, Pennsylvania
	Death	1882-03-26 Crawford, Pennsylvania
<b>6M</b>	<b>Allen, Reuben Albert</b>	
	Birth	1864-07-27 Titusville, Pennsylvania
	Death	1900-04-12 Mound City, Campbell, South Dakota, US
<b>7M</b>	<b>Allen, Harry J.</b>	
	Birth	1869-03-14 Meadville, PA
	Death	1929-11-18 Mound City, Campbell, South Dakota, US
	Spouse	Hankins, Mattie Mae
<b>8M</b>	<b>Allen, Frank Elmer</b>	
	Birth	1871-07-15 Titusville, Pennsylvania
	Death	1946-01-21 Kelso, Cowlitz Co., WA, Cowlitz, Washington
<b>9M</b>	<b>Allen, Rolland Benedict</b>	
	Birth	1876-02-26 Titusville, Pennsylvania
	Death	1937-12-10 Tacoma, Washington, Pierce, Washington
<b>10F</b>	<b>Allen, Anna Louella</b>	
	Birth	1879-02-04 Meadville, PA
	Death	1941-01-15 Lemmon, South Dakota
	Spouse	Loy, Samuel
	Marriage	1895-12-25 Mound City, South Dakota

# Campbell County Convergence

## Relationships of Homesteaders to Lucia Robbins Allen

With this background, the homesteading families can be understood based on the relationships of the heads of households to Lucia Robbins Allen in the 1890s. I tend to think of her as the matriarch of or virtual focus at the center of this group of settlers. I wonder if she viewed herself in this manner.

Here are Lucia's . . .

- Husband
  - James H. Allen (husband)
- Siblings and Their Children
  - John E. Robbins (brother)
  - Charles Stuart (brother in-law; married to sister Martha Naomi Robbins)
  - Columbus Hatch (brother in-law, married to sister Louisa Esther Robbins)
    - Frank Hatch (nephew, son of Columbus and Louisa)
- Children
  - Sam Loy (son in-law, married to daughter Anna Louella)
  - Harry J. Allen (son, married to Mattie Hankins)
  - Myron Kimmy (son in-law, married to daughter Mary Electa Allen)
  - Albert R. Allen (son, married to Mary Hanes/Kightlinger (also from Crawford Co.))

# Campbell County Convergence

Here is a revised version of the original picture, now showing the relationships to Lucia, depicted with the yellow star. Blue lines point to sons/daughters/nephew. Green lines lead to sisters/brother.

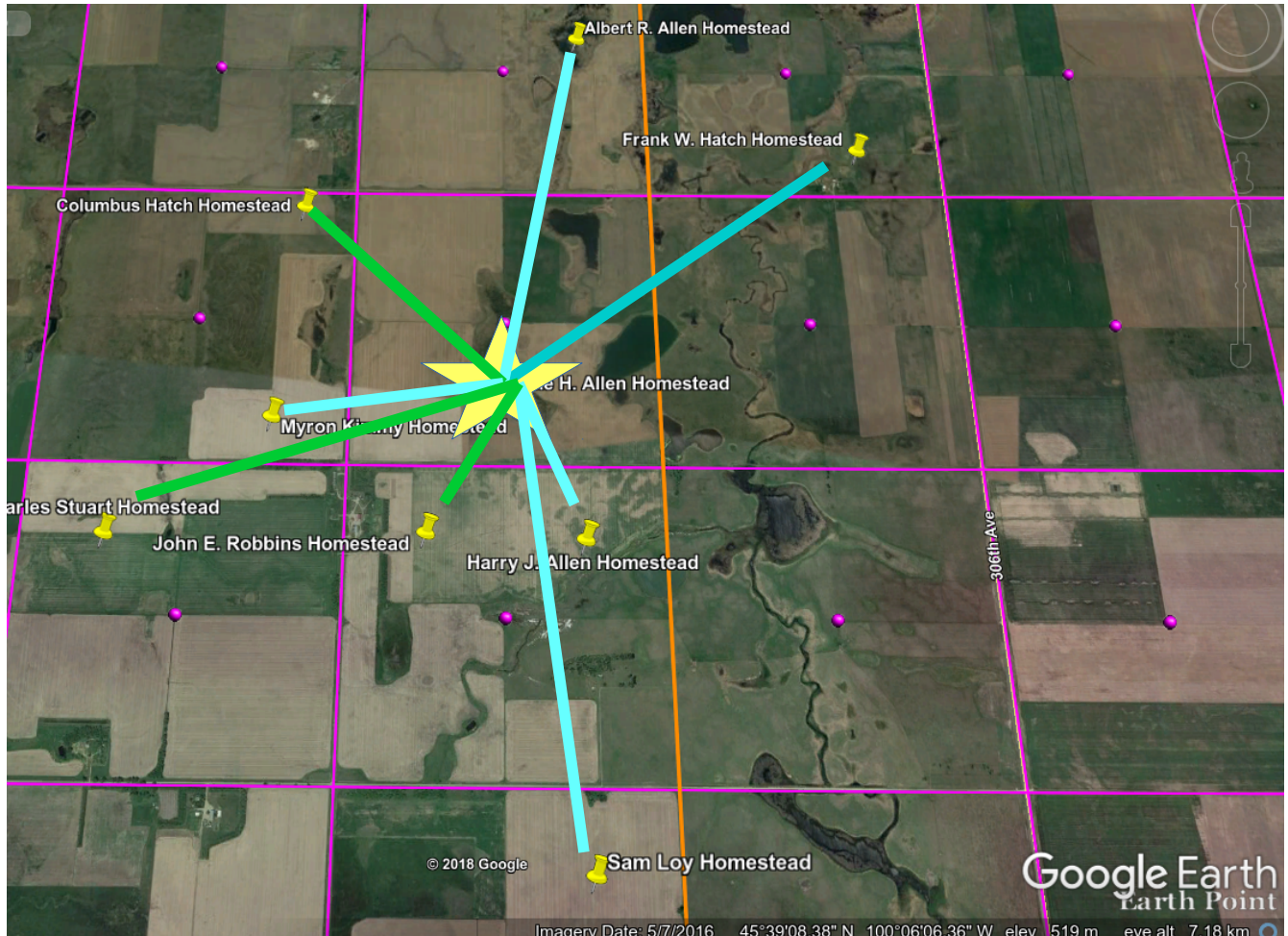



# Campbell County Convergence

## Family Details

Following is some more detail about some of the households. The John Allen publication mentioned above has more details. There is also a nice representation of many Robbins descendants associated with Lucia's sister, Louisa, in the ancestry.com tree (Bellman Family tree) maintained by "dustyfeathers" - <https://www.ancestry.com/family-tree/tree/9544262/family?cfpid=300046752368> .

## Lucia Robbins and James H. Allen

I know of no pictures of James Allen, so I start with pictures of Lucia.



### An Early Picture of Lucia Robbins

Picture Source = <http://www.forgottenphotosproject.com/> (You can find many pictures that show the Robbins daughters. Apparently these were owned by Sophia Robbins. They were discovered in AK, where she had moved with her husband.)

### A Later Picture of Lucia Robbins Allen

From the document by John Allen mentioned earlier.

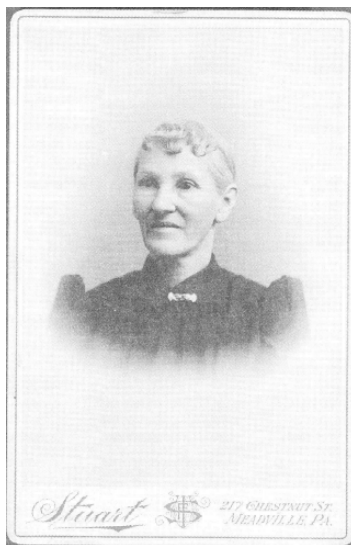

Rather than re-write a description of this family, I'll just include a few excerpts from John Allen's publication and refer you to the family group sheet presented here earlier. Following is text describing James H. Allen's life. Along with that are copies of obituaries for him and Lucia.

# Campbell County Convergence

The study of James Henry is fascinating. We have no record of his place of birth except that it was in New York. The records of Lillian Allen state that he came from Brant, Cattaraugus County, although Brant is now in Erie County. We find his name in the federal census of Crawford County, Pennsylvania of 1850. In 1854 he married Lucia Elila Robbins, the daughter of John Edwin Robbins Jr. and Electa Warner. Only in the 1860 census is his mother "Mercy" listed with the family. The 1860 and 1880 censuses list him as a farmer. The 1870 census as a butcher age 39. In the 1880 census his wife Lucia age 45 and seven children are listed: Mary age 21, John age 19, Albert age 17, Harry age 12, Frank age 11, Rolland age 4, and Anna age 1. Presumably his mother had died by 1870. At any rate, James must have changed occupations from butcher to farmer. We have no photos of Elisha or James. In 1882, court house records show that James purchased two parcels of land in Crawford County. It seems reasonable to infer that his holdings would not be sufficient to provide employment for James and his five sons.

## Background about James H. Allen

## Obituary for James H. Allen

James H. Allen  
Allen, at his home near Mound City, Campbell County, Dakota died of typhoid pneumonia at age 55 years, 11 months and 25 days. Deceased was born in Brant, Cattaraugus County, N.Y. November 29, 1831 and died November 24, 1888. He moved from his native state to Crawford County Pa. when he was about nineteen, where he lived until Oct., 1885, when he, with his family, except one son, emigrated to Dakota. He died in the absence of his wife who was visiting with friends in Crawford.

## OREGON CITY ENTERPRISE, FRIDAY, OCTOBER 28, 1910

### Mrs. Lucia Allen Passes Away.

Mrs. Lucia Allen, who has resided in this city for the past four years, passed away at the home of her son, Frank Allen on Thursday, October 20, after a brief illness. This makes the second death in the Allen family within one week, their 13 month old baby having died with infantile paralysis on Monday night, a few days previous.

Mrs. Allen's maiden name was Lucia Robbins and she was the daughter of Mr. and Mrs. John Robbins of Crawford County, Pa. Mrs. Allen was born in Crawford County, October 15, 1833 and was aged 77 years at the time of her demise. She was married to James Allen when she was 19 years of age. Mr. Allen having died in the year 1888. Since the death of her husband, Mrs. Allen has made her home with her son, Frank.

After the death of Mr. Allen in Dakota, Mrs. Allen accompanied her son to Alberta, Canada, and from that place came to Canby.

Deceased leaves, besides her son, Frank E., of this city, three other sons and two daughters, who are Rolland, of Alberta, Canada, John of Meadville, Pa., Henry (sp) of Campbell, S.D., Mrs. Anna Loy of Campbell, S.D., Mrs. Mary Kimmy, of Sumas, Wash.; the latter who attended the funeral.

Funeral services were held at the family residence on Saturday afternoon at 2 o'clock and the interment was in the family plot in Zion Cemetery. The services were attended by many friends of the family and many beautiful flowers covered the casket.

Mr. and Mrs. Allen have many friends in this city who deeply sympathize with them.

## Obituary for Lucia Robbins

# Campbell County Convergence

## John E. Robbins (brother)

I don't know much about John E. Robbins III. Based on ancestry.com trees, he may have been married to one or more ladies with maiden name of Price.

More research could be done into his history, but for now it appears that he was born on 3/5/1831 in Livingston Co., NY, and he died on 4/9/1901 in Erie Co., NY.

This means that he must have sold or forfeited the homestead in Campbell Co., SD. Further research might yield the details.

# Campbell County Convergence

## Charles Stuart and Martha Naomi Robbins (sister)

Below is an early photo of Martha from a collection found in Ankorage, AK. This was presumably taken there by her sister Sophia, who moved there with her husband. (See <http://www.forgottenphotosproject.com/> )

Martha was married to Charles Stuart in Meadville on 4/15/1866. The second photo that follows shows the family after relocating to Vernon Co., WI. She was born in 1845 and died in 1936 (at age 91!).

She/they had four children – Gertrude Helen, Eva Mae, Eva C., and Louise F.



Picture of Martha Naomi Robbins



Charles Stuart family photo

back, 3 Stuart daughters & 2 grandsons: Eva (Mrs. Will Hornby) & Ray; Gertie (Mrs. Mart Hornby) & Roy; Louise front: Charles and Martha Naomi Robbins Stuart (Stewart)

from [https://www.ancestry.com/family-tree/person/tree/109341513/person/390074702480/facts?\\_phsrc=Hde7&\\_phstart=successSource](https://www.ancestry.com/family-tree/person/tree/109341513/person/390074702480/facts?_phsrc=Hde7&_phstart=successSource)

# Campbell County Convergence

## Columbus Hatch and Louisa Esther Robbins (sister)

Here is a compilation of information from various sources in order to give some feeling for the Hatch / Robbins family.

### Hatch, Columbus

BATTLE UNIT NAME: **33rd Regiment, Wisconsin Infantry**

SIDE: Union

COMPANY: K

SOLDIER'S RANK IN: Corporal

SOLDIER'S RANK OUT: Corporal

ALTERNATE NAME: M559 ROLL 13

FILM NUMBER: none

PLAQUE NUMBER:

NOTES:

First, from findagrave memorial 95317120, there is the following text about Columbus. - "Moved to Wisconsin . . ., joined the northern army . . ., Civil War veteran, saw action with General Sherman, to Campbell County in 1885. Married Louisa Robbins." Other information from ancestry.com sources indicates that he was born on Crawford Co., PA, on 6/2/1826. He married Louisa Robbins on 4/17/1850 in Blooming Valley, PA. He died in Campbell Co., SD, in May, 1904. Clearly he had an active life.

Louisa was born in Livingston Co., NY, in 1829 and died in 1922 at age 93(!). She is buried in Crawford Co., PA, so she must have moved back to PA some time after the death of Columbus. (The 1910 to 1920 federal and South Dakota census enumerations should clarify this.)

I believe that they had six children: Frank, Ira, George, Mary ("Minnie"), Cora, and Virgil. (I have not tracked this family in detail.) The children were born in an assortment of locations, which reflects the family's movement from PA to WI to SD.



Columbus, Ester and Minnie E, 1861 Wis.

This photo from the Bellman Family Tree at ancestry.com may show Columbus, Louisa, and new daughter Mary.

see - [https://www.ancestry.com/family-tree/person/tree/9544262/person/-658181930/facts?\\_phsrc=fyk2&\\_phstart=successSource](https://www.ancestry.com/family-tree/person/tree/9544262/person/-658181930/facts?_phsrc=fyk2&_phstart=successSource)

## Picture of Columbus Hatch and Louisa Esther Robbins

# Campbell County Convergence

## Harry J. Allen (son) and Mattie Hankins

Findagrave.com memorial 94249808 has some information about this family. - <https://secure.findagrave.com/cgi-bin/fg.cgi?page=gr&GRid=94240808>

### Harry Jay Allen

Memorial Photos Flowers Share Edit

[Learn about sponsoring this memorial...](#)

**Birth:** Mar. 14, 1867  
Meadville  
Crawford County  
Pennsylvania, USA

**Death:** Nov. 18, 1929  
South Dakota, USA

Son of James and Lucia Allen, married October 31, 1895, to Hattie Hankins.

**Family links:**  
Spouse:  
[Hattie Hankins Allen \(1875 - 1952\)\\*](#)

**Children:**  
[Emma Ida Allen Mc Elrea \(1896 - 1956\)\\*](#)  
[Millie Clara Allen Alexander \(1897 - 1929\)\\*](#)  
[Claude Henry Allen \(1899 - 1974\)\\*](#)  
[Clarence Elmer Allen \(1901 - 1961\)\\*](#)  
[Estelle Irene Allen \(1901 - 1983\)\\*](#)

[\\*Calculated relationship](#)

**Burial:**  
[Mound City Cemetery](#)  
Mound City  
Campbell County  
South Dakota, USA

Created by: [Donald Schmidt](#)  
Record added: Jul 26, 2012  
Find A Grave Memorial# 94240808



Cemetery Photo  
Added by: [Jim Olson](#)

[Add a photo for this person](#) [Request A Photo](#)

Photos may be scaled.  
Click on image for full size.

[Leave flowers and a note](#)

Although, I have found no photos of Harry, I have found photos of his son, Claude Allen, who was a MN state legislator. (<https://www.leg.state.mn.us/legdb/fulldetail?id=10882> )



# Campbell County Convergence

## Myron Kimmy and Mary Electa Allen (daughter)

This family relocated to Canada from South Dakota, and Lucia relocated with them as well. Eventually, the family moved to McCleary, WA. Some great photos and family history follow.



### Myron\_Kimmy\_family picture

Found on Carmen's Genealogy Website:

<http://www.geocities.com/lux731/index.html> Myron Samuel KIMMY and wife Mary Electa ALLEN, with their children Alice Lucia and George Samuel.

Georgina Smith, a descendant of Mary and Myron, has written the following on [familyserach.org](http://familyserach.org). -

“Myron Samuel Kimmy was the seventh child born to Peter Kimmy and Mary Pike in Meadville, Pennsylvania. He had one younger brother, Perry, who was four years younger. Their mother died when Myron was eight years old. In 1870 Census he was dwelling with Samuel Hobbs, and wife, who was a hotel keeper in Meadville Ward 2. He was age 13 and worked in a Cigar Factory. Nov 8 1883 he married Mary Electa Allen in Blooming Valley, Crawford County, Pennsylvania. In 1900 they were living in Madison Township Lake County, Ohio where his brother Perry lived. Occupation

of Myron was carpenter. In this Census Mary indicated that she was the mother of 4 children and 3 were living.

No information has been found about the other child who would have had died young. When they moved to Alberta Canada Myron applied for Canadian Citizenship. He farmed on a homestead obtained. When he went to Washington State in 1910 he had to apply for United States Naturalization which seemed rather strange since he was born in Pennsylvania, United States. “

A picture follows that was taken in Canada. It shows this family and assorted relatives.

# Campbell County Convergence



Photo taken at the Rolla Allen home in the Chesterwold Alberta area about 1904.

Standing L-R: Rolla Allen; Anna Allen Loy; George Kimmy; Frank Allen;  
Hugo Unland (husband of Alice).

Seated L-R: Lena Allen (wife of Rolla) holding baby Arthur with daughter Clara Allen seated in  
front of her; Lucia Allen (mother); Mary Allen Kimmy with Evalyn Kimmy seated in front of her; Mabel  
Allen (wife of Frank); Alice Kimmy Unland; Myron Kimmy (husband of Mary).

## Myron\_Kimmy\_family picture in Canada

Found on Carmen's Genealogy Website: <http://www.geocities.com/lux731/index.html>



# Campbell County Convergence

## Albert R. Allen (son) and Mary Hanes/Kightlinger

Albert was born in Crawford County, PA, and died an early death in Campbell County, SD. He apparently died from an injury inflicted by a horse early in 1900. (See his findagrave.com memorial #94240293. - <https://secure.findagrave.com/cgi-bin/fg.cgi?page=gr&GSln=allen&GSiman=1&GScid=97264&GRid=94240293&> )

495

Marriage License Docket of the Orphans' Court of Crawford County.

Mr. Albert R. Allen ✓  
- to -  
Ms. Mary J. Hanes ✓

Marriage License No. 2486

On this 10<sup>th</sup> day of February, A. D. 1891, appeared  
Mr. Albert R. Allen and applied for a license for the marriage of  
Mrs. Mary J. Hanes, a resident of the County of Campbell, State of Dakota,  
who was 26 years of age on the 27<sup>th</sup> day of July, last past,  
to Miss Mary J. Hanes, a resident of the County of Crawford, State of Pennsylvania,  
who was 22 years of age on the 11<sup>th</sup> day of February, last past.

And the said Mary J. Hanes being a minor, the consent of  
her father, Arthur Kightlinger, her parents  
of the said minor in the contemplated marriage was first given before said Clerk personally (by proper legal certificate, filed and  
duly signed, attested and acknowledged).

Designation of Aides, Surver  
Occupation of Woman, Nurse  
Relationship of parties, if any, before marriage, None  
Former state of man, married or single, Single  
Former state of woman, married or single, Single  
If married, date of death or divorce of man's wife,  
If married, date of death or divorce of woman's husband,

Seven days, the Clerk of the Orphans' Court inquired upon with \_\_\_\_\_ of the said  
applicants relative to the legality of the said contemplated marriage, and it appearing that there is no legal impediment therein, a  
marriage license in due form was issued, authorizing any Minister of the Gospel, Justice of the Peace, or other person authorized  
by law to solemnize marriages, to join said Albert R. Allen and  
Mary J. Hanes together in the holy state of matrimony.

From this 11<sup>th</sup> day of March, A. D. 1891, there was received and  
that they certify as follows to wit:  
"I, T. R. Loringhead, hereby certify, that on the 11<sup>th</sup> day of February  
A. D. 1891, at Mead, S. D. Pa. Mr. Albert R. Allen  
and Mrs. Mary J. Hanes were by me united in marriage in accordance with license  
issued by the Clerk of the Orphans' Court of Crawford County, Pennsylvania, numbered 2486."

T. R. Loringhead, Minister of the Gospel  
H. H. Gaskill, Clerk Orphans' Court Crawford County

Here is a copy of the marriage license for Albert and Mary.

Albert's wife, Mary Jane, was a part of the William Kightlinger family, which settled in the same area in Campbell Co., SD. Her maiden name is reported as Hanes, however, and she was born prior to the marriage of William to his wife, Anna. So, there is a story waiting to be discovered to explain her association with the William Kightlinger family. The Kightlingers were also from Crawford Co., PA, and they are likely related to a large number of people in PA with the same surname.

After Albert's death, Mary remained in the Campbell Co. area until her death in 1923. It appears that her children remained in the area as well.

# Campbell County Convergence

## Sam Loy and Anna Louella Allen (daughter)

Following are pictures of Sam and Anna extracted from other group pictures.



**Sam Loy**



**Anna Louella Allen**

Anna's birth family is fairly well described above. Sam was from Ohio, and there exists some information about him that I believe is inaccurate. Based on my research, I believe that he was born in 1859 to John (Johann) Loy and Susanna Snyder, who were married in 1857.

Sam's father immigrated from Baden just after the 1848 Revolution that preceded the formation of a united German state in 1871. Johann had been married to Sophia Kaelber, who had previously been married to Jakob Heidegger. (Sophia and Jakob had three children, some of whom I believe immigrated to the US and adopted the surname Hydaker.) In any event, Johann and Sophia had three children (John E., Catherine, and Mary). Sophia either died in transit to the US or shortly before.

When John/Johann married Susanna, their family consisted of themselves and John's three children. (Susanna was part of a family that came to OH from PA.) John and Susanna had four children (Christina, Lizzie, Sophia, and **Sam**). Sometime, not too long after Sam's birth in 1859, Susanna disappears from the family for an undocumented reason.

In 1863 John marries again, this time to "Mariah Augustine" according to a marriage certificate. Based on period records for the area in Ohio around Prospect and Waldo, OH, where John lived, I suspect that Mariah's surname was actually Augenstein and that her full name was Maria Catherina Augenstein. Although exact dates are somewhat elusive, John and Maria added two children (Mary M. and Sarah Ann) to the family.

The point of all of this is that Sam had a number of siblings in OH. Their own families are pretty well documented and confirmed from DNA testing. There is no evidence that I have seen that Sam participated in the Civil War as suggested by findagrave.com memorial 95504249.

# Campbell County Convergence

I believe that in 1882 (age 23) Sam married Margaret Rower. They had a child named William H. (b.1883). However, something happened that resulted in Sam moving to South Dakota and Margaret marrying Sam E, Clevenger (a former neighbor of Margaret's) in 1891. William was left with his maternal grand parents, James and Sarah Rower. [All of this is based on paper records, but I hope to confirm it through DNA testing.]

So, this brings us back to the story in South Dakota, where Sam encounters Anna Allen and marries her in 1895. There is likely a 20 year difference in their ages, not the 30 years reported by some. Their own family is depicted in the family group sheet that follows.

# Campbell County Convergence

## Family Group Report

<b>Husband: Loy, Samuel</b>		
Birth	date conflicts with headstone, but syncs with other public records.	
	1859-01-06	Marion, Ohio
Death	see death certificate	
	1920-10-28	Adams, North Dakota
Father	Loy, John	
Mother	Snyder, Susannah	
<b>Wife: Allen, Anna Louella</b>		
Birth	1879-02-04	Meadville, PA
Death	Bismark - actually died in Bismark hospital of leukemia	
	1941-01-15	Lemmon, South Dakota
Father	Allen, James Henry	
Mother	Robbins, Lucia Elila	
<b>Children</b>		
<b>1F</b>	<b>Loy, Ruth Irene</b>	
	Birth	1896-10-02 Campbell, South Dakota
	Death	1958-11-06 Lemmon, South Dakota
	Spouse	Scoular, William Thomas
	Marriage	1918-10-15 Perkins, South Dakota
<b>2M</b>	<b>Loy, Guy Elmer</b>	
	Birth	1898-01-08 Campbell, South Dakota
	Death	1923-09-03 Campbell, South Dakota
	Spouse	Thompson, Agnes Georgann
	Marriage	1922-06-28 Walworth, South Dakota
<b>3F</b>	<b>Loy, Marian Evelyn</b>	
	Birth	1900-05-06 Campbell, South Dakota
	Death	1995-10-30 Mound City, Campbell, South Dakota, US
	Spouse	Bates, Harry C.
	Marriage	1921-03-27
<b>4M</b>	<b>Loy, Arlo Wilmot</b>	
	Birth	1902-11-23 Campbell, South Dakota
	Death	1906-01-04 Campbell, South Dakota
<b>5M</b>	<b>Loy, Ralph Samuel</b>	
	Birth	1906-09-08 Lyman, South Dakota
	Death	1991-12-31 Mount Vernon, Skagit, Washington
	Spouse	Thompson, Agnes Georgann
<b>6M</b>	<b>Loy, Howard Allen</b>	
	Birth	1910-05-05 Campbell, South Dakota
	Death	1972-02-15 Sandpoint, Bonner, Idaho
	Spouse	Peterson, Ina

# Campbell County Convergence

Here is an excerpt from John Allen's publication that focuses on Anna but describes the exploits of the Allen/Loy family better than any other source of which I am aware.

1879: Edison invents the electric light.  
1880: First electric street lights in NewYork.  
General Douglas McArthur born.

## ANNA LOUELLA (ALLEN) LOY

Born 4 February 1879 in Meadville, Pennsylvania.  
Died 15 March 1941 in Lemmon, South Dakota.

Anna was the youngest of ten children born to James Henry Allen and Lucia Elila Robbins. When she was only six years old the family moved to Campbell County, Dakota Territory with six of their children. James took up a homestead six miles south and two miles west of Mound City. She wrote of her vivid memories of growing up on the prairie, and how on a gala day each child was given ten cents to spend. She was sure that boys and girls never had as much fun as they had in those days. She also recalled the time when her father, who was a justice of the peace, received a five dollar gold piece for a court fee. Anna begged to be allowed to hold it. She dropped it and it rolled between the floor boards, which had to be taken up to retrieve it. Summers found the younger children herding cattle for neighbors. For 25 cents per head the cattle were cared for from May till October. Since they had to herd their own cattle "the money was a clear gain." Much of their riding was done on calves or steers.

Only three years after the move, Father James Henry died of influenza while Mother Lucia was visiting in Pennsylvania.

This was such a shock to Lucia that she took Frank, Rolla and Anna, the three youngest, and moved back to their farm in Crawford County, Pennsylvania, where they stayed for several years before returning to South Dakota. When she was 16 years old (1895) she married Sam Loy who was 46 years old at that time. The couple had 6 children, Ruth, Guy, Marian, Ralph, Howard and Arlo. They farmed southwest of Mound City, adjacent to other family members. Because of their operation, which was increasingly directed toward livestock, they needed more land, and in 1916 they moved to a new place, 7 miles north of



Lemmon, South Dakota (in North Dakota). Grandson Ralph Scoular describes the operation. They farmed 80 acres and used 1500 acres for grazing livestock. All in all, they operated about 1600 acres. Son Guy did most of the farming as Sam was gone a good deal, buying livestock. Their main source of income was buying and selling horses. They also raised pigs, and cattle which they fattened for slaughter. Anna was a great reader, a lifelong student, a good singer, and played the organ well. She was a fine horseman, an expert with the bull whip, and a crack shot. Sam died in 1920 at age 71. Anna was 41 at that time. She and the children continued to operate the farm for as long as they were able. Anna then moved into Lemmon where she lived for the rest of her life. She died of leukemia, in 1941, at age 62. Anna was a life-long Christian, reared in the Methodist faith. Some time in the early 1930s the Church of God held tent meetings in Lemmon. During those meetings Anna had a life-changing spiritual awakening. Her Christianity became greatly intensified after that experience. Howard, her youngest child, came to the Lord after a near drowning, and was a great joy to his mother.

Ruby Beckman, later to become a lay pastor, lived with Anna during the 1935-36 school year. She writes about the profound influence which Anna had on her, and about how, in a very patient and tender way, she led Ruby's brother to the Lord. Photos taken late in her life show a radiant and joyful person. The reader is referred to two articles written by Anna for details of her early life. She was certainly a remarkable woman. *From "Memories" by Anna Loy and from information supplied by Duane and Ralph Scoular and Ruby Beckman*

## RUTH IRENE LOY

Born on 2 October 1896 In Lemmon North Dakota.  
Died on 6 November 1958 in Lemmon, South Dakota.

Ruth was the first of six children born to Samuel Loy and Anna Louella Allen. She grew up on farms in the Mound City and Lemmon South Dakota areas. Since her father was gone a great deal, she was very active in the

farming operation. She completed her high school education and attended normal school in Aberdeen,



# Campbell County Convergence

## A Robbins Family Bible

A few years ago, a bible was discovered in SD that is special to the descendants of Robbins/Warner family. The provenance of the bible is as follows.

- 1864 - Published in Hartford, CT, by Case, Lockwood and Company. (This is interesting, even if it is a coincidence, as the maternal line of this family traces back to Colonial CT (Hartford, New Haven ,etc.))
- 1864 – Given to Daughter Lucia by her father John Robbins within a year of the death of his wife Electa Warner.
- 1873 – Passes from Lucia Robbins Allen to her daughter Mary Electa Allen Kimmy.
- 1898 – Passes to the youngest daughter of Lucia, namely Anna Luella Allen Loy.
- 1941 – Passes to Anna’s daughter Marian Loy Bates.
- 1980 – Passes to Marian’s daughter Shirley Bates Nelson.
- 2004 – Passes to Shirley’s daughter Kristie.

The bible was restored in 2004. Unfortunately, nothing was recorded in the bible other than its passage along the maternal line. It is a special artifact that documents part of an interesting maternal line that can be traced to Colonial CT and then to England.

# Campbell County Convergence

Here are pictures.



Before restoration. The inscription reads "Lucia Allen."



After restoration.

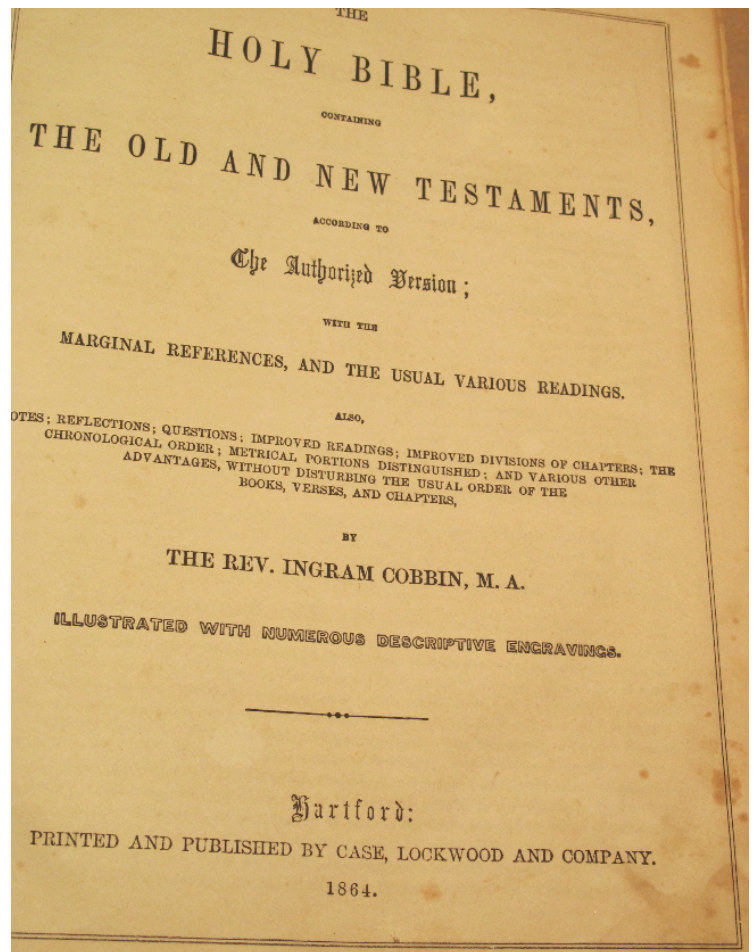

# Campbell County Convergence

## Related Census Information

Basic information for this time period comes from two sources – the 1895 South Dakota Census and the 1900 Federal Census. Following are excerpts from these sources that support the analysis above that is centered on land patents.

Sheet No. 1 CENSUS FOR 1895  
 Enumeration of Residents of Ferris Township, Precinct, 10  
 in Campbell County.

INSTRUCTIONS.—Place age of each person in proper sub-division as in age under "M" for Males and "F" for Females. In proper column, under word "Nationality," place check mark after each name, and in column marked "Misc.," place S for Spanish, T for Turk, C for Chinese, B for Bohemian; any other may be noted by some initial and the initial explained by the enumerator. All persons born in the United States must be classed as natives.

NAME	AGE AND SEX						NATIONALITY							
	Under 6 Years		Over 6 Years and Under 20		Over 20 Years		Native	Born	British	Scott	German	Danish	French	Misc.
	M	F	M	F	M	F								
1 Samuel Loy					31					X				
2 Harry J. Allen					27									
3 Frank Allen					23									
4 Bally					19									
5 Lucia														59
6 Anne						16								
7 A. B. Allen						29								
8 Mary														25
9 Grace		2												
10 Ethel			1/2											
11 F. W. Hatch						43								
12 J. A. Hatch						40								
13 Mary														37
14 Alvord					9									
15 Agnis		7		7										
16 Arthur					6									
17 Marcan		4												
18 Sara					2									
19 C. B. Hatch						68								
20 Louise														65
21 V. V. Hatch						25								
22 Venona														31
23 Hazel					3									
24 Lute		1												
TOTAL	3	3	4	4	9	5	14							

This page of the 1895 South Dakota Census shows names and ages of people in Allen and Hatch families.

Sam Loy's name is at the top of the list. (His age is off by 5 years. He should be 36.) His future wife, Anna Allen is shown on line 6. Her age is reported correctly. Anna is with her mother Lucia and brother "Rolly" in Frank Allen's house (her brother).



# Campbell County Convergence

Sheet No. 2  
**CENSUS FOR 1895.**  
 Enumeration of Residents of *Hammer* City, Village, Township, Precinct, *10*  
 in *Campbell* County.

INSTRUCTIONS.—Place age of each person in proper subdivision as to age under "M" for Males and "F" for Females. In proper column, under word "Nationality," place check mark after each name, and in column marked "Misc.," place S for Spanish, T for Turk, C for Chinese, B for Bohemian; any other may be noted by some initial and the initial explained by the enumerator. All persons born in the United States must be classed as natives.  
 \*Cross out words not needed.

No.	NAME	AGE AND SEX						NATIONALITY										
		Under 4 Years		Over 4 Years and Under 10		Over 10 Years		Maine	Mass.	Brit.	Scott.	German	Irish	Norse	Danish	French	Ital.	
		M	F	M	F	M	F											
25	Vincinele Jelich						45											B
26	Josephine						40											B
27	Frank				8													
28	Vincent		5															
29	Anne			3														
30	Charles Bartholome						27											
31	Leina						29											
32	Gilbert Haugstad						24											
33	M. J. Ruster						28				S							
34	Mary						25											
35	Josef			1														
36	Stuart						55											
37	Marta						49											
38	Luise					7												
39	Myran Kimmy						38											
40	Mary E						37											
41	George				7													
42	Alice				5													
43	Salve Lovorsan						58											
44	Sidse						55											
45	Salve				17													
46	Guri						15											
47	Besse						13											
48	Sapie						9											
49	Nils K. Holand						36											B
		✓	✓		3	4	7	7	14						7	2		18

This image from 1895 shows the Stuart and Kimmy families.

# Campbell County Convergence

Here is part of a page from the 1900 census – covering part of Fairview Township.

TWELFTH CENSUS OF THE UNITED STATES. B

State South Dakota } **SCHEDULE No. 1.—POPULATION.** { Supervisor's District No. 2 } Sheet No. 3  
 County Campbell } { Enumeration District No. 375 }

Township or other division of county Fairview 25 Range 17 Name of Institution, \_\_\_\_\_  
 Name of incorporated city, town, or village, within the above-named division, \_\_\_\_\_ Ward of city, \_\_\_\_\_  
 Enumerated by me on the 17<sup>th</sup> day of June, 1900, Gilbert Ryfle, Enumerator. 5918

LOCATION.			NAME of each person whose place of abode on June 1, 1900, was in this family.  Enter surname first, then the given name and middle initial, if any.  Include every person living on June 1, 1900. Omit children born since June 1, 1900.	RELATION Relationship of each person to the head of the family.  (State or rank.)	PERSONAL DESCRIPTION.							NATIVITY.			CITIZENSHIP.			OCCUPATION, TRADE, OR PROFESSION of each person TEN YEARS OF AGE and over.		EDUCATION.				OWNERSHIP OF HOME.				
IN CITY.	Home Number.	Number of family in this household.			Sex.	Age.	Color.	Married.	Year.	Age last birthday.	Whether blind, deaf, or dumb.	Number of years married.	Number of years born here.	Number of these children living.	Place of birth of this parent.	Place of birth of father of this person.	Place of birth of mother of this person.	Has this person ever been naturalized in the United States.	Number of years in the United States.	Immigration.	OCCUPATION.	Years of schooling.	Attended school last year.	Can read.	Can write.	Can speak English.	Owned or rented.	Owned free or mortgaged.
1	2	3	4	5	6	7	8	9	10	11	12	13	14	15	16	17	18	19	20	21	22	23	24	25	26	27	28	29
	43	44	Hatch, Copeland W.	Head	M	Jun	1826	73	M	50			Pennsylvania	New York	Vermont				Farmer	0	yes	yes	yes					
			Louisa	Wife	F	Dec	1829	70	M	50	6		New York	Connecticut	New York				Farmer	0	yes	yes	yes					
			Margit W.	Son	M	Jun	1878	22	M	11			Pennsylvania	Pennsylvania	New York				Farmer	0	yes	yes	yes					
			Winnifred	Daughter	F	Jan	1868	32	M	11	2	2	Missouri	New York	New York				At School	6	yes	yes	yes					
			Hazel	Grand D.	F	Nov	1891	8	S				South Dakota	Pennsylvania	Wisconsin				At School	6	yes	yes	yes					
			Elmer	Grand Son	M	Jun	1898	2	S				South Dakota	Pennsylvania	Wisconsin				At School	6	yes	yes	yes					
	44	45	Allen, Myrtle B.	Head	M	Feb	1870	30	M	11	4	4	Pennsylvania	Pennsylvania	Pennsylvania				Farmer	0	yes	yes	yes					
			Earle C.	Son	M	Jun	1872	27	S				South Dakota	Pennsylvania	Pennsylvania				At School	6	yes	yes	yes					
			Ethel C.	Daughter	F	Nov	1876	23	S				South Dakota	Pennsylvania	Pennsylvania				At School	6	yes	yes	yes					
			Joseph J.	Son	M	Jul	1876	23	S				South Dakota	Pennsylvania	Pennsylvania				At School	6	yes	yes	yes					
			Oliver G.	Daughter	F	Aug	1878	21	S				South Dakota	Pennsylvania	Pennsylvania				At School	6	yes	yes	yes					
			Rightling, Robert	Brother	M	Mar	1876	24	S				Pennsylvania	Pennsylvania	Pennsylvania				Farm Labour	2	yes	yes	yes					
	45	46	Hatch, Donald	Head	M	Oct	1852	47	S				Pennsylvania	Pennsylvania	New York				Farmer	0	yes	yes	yes					
	46	47	Rightling, William	Head	M	May	1821	78	M	23			Pennsylvania	Pennsylvania	New York				Farmer	0	yes	yes	yes					
			Anniston	Wife	F	Jun	1829	70	M	23	6	6	Pennsylvania	Ohio	New York				Farmer	0	yes	yes	yes					
			William	Son	M	Jul	1877	22	S				Pennsylvania	Pennsylvania	Pennsylvania				Farm Labour	6	yes	yes	yes					
			William	Son	M	Jan	1871	29	S				Pennsylvania	Pennsylvania	Pennsylvania				Farm Labour	4	yes	yes	yes					
			Supernard	Son	M	Dec	1881	18	S				Pennsylvania	Pennsylvania	Pennsylvania				Farm Labour	0	yes	yes	yes					
	47	48	Allen, Rolla B.	Head	M	Feb	1876	24	S				Pennsylvania	New York	New York				Farmer	1	yes	yes	yes					
			Lucia C.	Mother	F	Oct	1846	53	M				New York	New York	New York				Farmer	1	yes	yes	yes					
			Harvey Elsie	Servant	M	Feb	1882	18	S				Illinois	Ohio	Indiana				Servant	2	yes	yes	yes					

The section of the 1900 census above shows Lucia with her son, Rolland, and helper named Elsie. -

Allen Rolla B.	Head	M	Feb	1876	24	S
Lucia C.	Mother	F	Oct	1846	53	M
Harvey Elsie	Servant	M	Feb	1882	18	S

# Campbell County Convergence

Also shown is the household of Lucia's recently widowed daughter in-law, Mary (wife of son Albert). Albert had died earlier in the year. Note that Mary's oldest brother, Robert Kightlinger, is present in the house with Mary's family. It makes sense that he is helping after the recent death of Albert. The rest of the Kightlinger family is nearby.

The fact that the Kightlingers do not appear in the 1895 census is an indication that they arrived in the area some time between 1895 and 1900.

Allen	Mary P.	Head	W	F	Feb	1870	30	Wd
---	Carl R.	Son	W	M	June	1892	7	S
---	Ethel C.	Daughter	W	F	Nov	1894	5	S
---	Jakob J.	Son	W	M	July	1896	3	S
---	Bliza P.	Daughter	W	F	Aug.	1898	1	S
Kightlinger	Robert W.	Brother	W	M	Mar	1876	24	S
Hatch	Frank W.	Head	W	M	Oct	1852	47	S
Kightlinger	William	Head	W	M	Aug.	1844	55	M 25
---	Bessie E.	Wife	W	F	June	1844	55	M 25
---	Hiram M.	Son	W	M	July	1877	22	S
---	William	Son	W	M	Mar	1891	19	S
---	Seymore S.	Son	W	M	Dec	1884	15	S

# Campbell County Convergence

Here is a part of another page from the 1900 census.

T-254. 197

TWELFTH CENSUS OF THE UNITED STATES. A

State South Dakota } **SCHEDULE No. 1.—POPULATION.** } Supervisor's District No. 2 } Sheet No. 5  
 County Campbell } } Enumeration District No. 375 }

Township or other division of county Fairfax } Name of Institution, \_\_\_\_\_ }  
(Insert name of township, city, precinct, district, or other civil division, as the case may be. See instruction.)

Name of incorporated city, town, or village, within the above-named division, \_\_\_\_\_ Ward of city, \_\_\_\_\_

Enumerated by me on the 6th day of June, 1900, Gilbert Gjeffe, Enumerator. 8911

LOCATION.			NAME	RELATION.	PERSONAL DESCRIPTION.						NATIVITY.			CITIZENSHIP.			OCCUPATION, TRADE, OR PROFESSION.				EDUCATION.				OWNERSHIP OF HOME.			
IN CITIES.	Male.	Female.			Color or race.	Age at last birthday.	Married.	Single.	Never married.	Widowed.	Divorced.	Place of birth of this person.	Place of birth of father.	Place of birth of mother.	Year of immigration to the United States.	Number of years in the United States.	Native born.	Occupation.	Can read.	Can write.	Can speak English.	Years of school.	Years of school.	Years of school.	Years of school.	Owned free or mortgaged.	Paids in full.	Number of farm buildings.
1	36	37	Amundson, A. and	Head	W M	April	1846	54	M 28	Norway	Norway	Norway	1869	31	na	Farmer	yes	yes	yes	0	na	na	na	na	na	na	na	
2			Amundson, M. and	Wife	W F	Mar	1852	48	M 10 6	Norway	Norway	Norway	1869	31			yes	yes	yes	0	na	na	na	na	na	na	na	
3			Amundson, J.	Daughter	W F	Nov	1872	28		South Dakota	Norway	Norway					yes	yes	yes	0	na	na	na	na	na	na	na	
4			Amundson, J.	Daughter	W F	Apr	1886	14		South Dakota	Norway	Norway				At School	7	yes	yes	yes	0	na	na	na	na	na	na	
5			Amundson, E.	Daughter	W F	Sept	1890	10		South Dakota	Norway	Norway				At School	6	yes	yes	yes	0	na	na	na	na	na	na	
6			Amundson, E.	Daughter	W F	Mar	1892	8		South Dakota	Norway	Norway																
7	37	38	Amundson, A.	Head	W M	Jan	1853	47	M 24	Norway	Norway	Norway	1873	27		Farmer	yes	yes	yes	0	na	na	na	na	na	na	na	
8			Amundson, M.	Wife	W F	Jan	1856	44	M 22 4 8	Norway	Norway	Norway	1871	29			yes	yes	yes	0	na	na	na	na	na	na	na	
9			Amundson, A.	Daughter	W F	Mar	1877	23		Minnesota	Norway	Norway				Farmer Laborer	4	yes	yes	yes	0	na	na	na	na	na	na	
10			Amundson, E.	Daughter	W F	Mar	1889	11		South Dakota	Norway	Norway				At School	6	yes	yes	yes	0	na	na	na	na	na	na	
11			Amundson, E.	Daughter	W F	Aug	1891	9		South Dakota	Norway	Norway				At School	6	yes	yes	yes	0	na	na	na	na	na	na	
12			Amundson, E.	Daughter	W F	Mar	1892	8		South Dakota	Norway	Norway				At School	6	yes	yes	yes	0	na	na	na	na	na	na	
13	38	39	Amundson, A.	Head	W M	Aug	1862	37		Minnesota	Norway	Norway				Farmer	yes	yes	yes	0	na	na	na	na	na	na	na	
14	39	40	Amundson, M.	Wife	W F	Jan	1860	40	M 4	Ohio	Germany	Germany				Farmer	yes	yes	yes	0	na	na	na	na	na	na	na	
15			Amundson, J.	Daughter	W F	Feb	1872	28	3 3	Connecticut	Germany	Pennsylvania					yes	yes	yes	0	na	na	na	na	na	na	na	
16			Amundson, J.	Daughter	W F	Oct	1896	4		South Dakota	Ohio	Pennsylvania																
17			Amundson, G.	Son	W M	June	1898	1		South Dakota	Ohio	Pennsylvania																
18			Amundson, M.	Daughter	W F	May	1900	0		South Dakota	Ohio	Pennsylvania																
19	40	41	Amundson, A.	Head	W M	Jan	1863	37		Norway	Norway	Norway	1885	15	na	Farmer	yes	yes	yes	0	na	na	na	na	na	na	na	

Included on this page is the family of Sam and Anna. -

40	Loz	Samuel	Head	W M	Jan	1860	40	M 4								Farmer	yes	yes	yes	0	na	na	na	na	na	na	na	na	
		Anna	Wife	W F	Feb	1879	21	M 4	3 3								yes	yes	yes	0	na	na	na	na	na	na	na	na	
		Ruth D.	Daughter	W F	Oct	1896	4																						
		Guy C.	Son	W M	June	1898	1																						
		Margaret	Daughter	W F	May	1900	0																						

Note that Sam is shown as having been born in 1860 – still one year off from the 1859 date that I suspect is accurate based on other evidence, like the 1860 federal census.

**281connections Wiki****About****Copyright(left)****Education****Privacy****South Dakota Families****Bates-Moodie****Loy-Allen****Ahnentafel****AncestralCollapsible****FamilyGroup****Fan****Snyder Family Research****Tracing mtDNA****Memorials****Mysteries****Rombs-Kessler****Thompson-Olsen****Texas Families**

## Ahnentafel (Ancestor) Reports

--

## Ahnentafel Report for Loy, Samuel

### Generation 1

1. **Loy, Samuel.** Samuel was born on 1859-01-06 in Ohio. He died on 1920-10-28 in Adams, North Dakota.

### Generation 2

2. **Loy Lay, Johann Georg.** Johann Georg was born on 1820-08-15 in Baden, Germany. He died on 1892-04-17 in Delphos, Allen, Ohio. He was buried on 1892-04-18.
3. **Snyder, Susannah.** Susannah was born in 1832 in Pennsylvania.

### Generation 3

4. **Lay, Johann Georg.** Johann Georg was born on 1792-04-30 in Baden, Germany. He died on 1865-09-18 in Gobrighen, Baden, Germany.
5. **Clauss, Christina.** Christina was born on 1797-10-01 in Dillstein, Baden, Germany. She died on 1823-07-21 in Gobrighen, Baden, Germany.
6. **Snyder, John.** John was born in 1804 in Pennsylvania.
7. **Culp, Catherine.** Catherine was born in 1795.

### Generation 4

8. **Lay, Georg Jacob.** Georg Jacob was born on 1750-11-30 in Gobrighen, Baden, Germany. He died on 1831-08-28 in Gobrighen, Baden, Germany.
9. **Leopold, Margarethe Salome.** Margarethe Salome was born on 1755-04-12. She died on 1830-04-13 in Gobrighen, Baden, Germany.
10. **Clauss Klaus, Jacob.**
11. **Bauer, Susanna Josepha Margaretha.**

### Generation 5

16. **Lay, Gottfried.** Gottfried was born on 1712-03-11 in Gobrighen, Baden, Germany. He died on 1787-05-20 in Gobrighen, Baden, Germany.
17. **Wüst, Elisabetha.** Elisabetha was born on 1720-09-16 in Gobrighen, Baden, Germany. She died on 1786-12-16 in Gobrighen, Baden, Germany.
18. **Leopold, Daniel.** Daniel was born on 1712-02-28 in Pforzheim, Baden, Germany. He died on 1768-05-22 in Pforzheim, Baden, Germany.
19. **Hochmuth, Dorothea.** Dorothea was born on 1719-11-14 in Pforzheim, Baden, Germany. She died on 1777-07-14 in Pforzheim, Baden, Germany.
20. **Clauss Klaus, Adam.**
21. **Muerrie Mural, Margaretha.**
22. **Bauer, Christian Ludwig.**
23. **Breyer, Rosina Barbara.**

### Generation 6

32. **Lay, Peter.** Peter was born on 1682-07-30 in Bodelshausen, Wurttemberg. He died in Gobrighen, Baden, Germany.
33. **Hoffsaess, Maria.** She was baptized on 1688-02-24. She died on 1757-02-09.
34. **Wüst, Johann Michael.** Johann Michael was born on 1677-09-23 in Pforzheim, Baden, Germany. He died on 1726-03-29 in Gobrighen, Baden, Germany.
35. **Argast, Anna Barbara.** Anna Barbara was born on 1687-02-02. She died on 1744-03-09 in Gobrighen, Baden, Germany.
44. **Bauer, Ruprecht.**
45. **Bruckmann, Anna Rosina.**
46. **Breyer, Michael.**

### Generation 7

64. **Lay, Peter.** He died in 1694.
65. **Schissler, Maria.**
66. **Hoffsaess, Hanss Jacob.** Hanss Jacob was born in 1654.
67. **Hoffsaess, Maria.**
68. **Wüst, Hanss Michael.** Hanss Michael was born in 1651. He died in 1733.
69. **Hoffsaess, Barbara.** Barbara was born in 1649. She died in 1731.
70. **Argast, Hans Jacob.** Hans Jacob was born in 1659. He died in 1744.
71. **Sigrist, Margaretha.** Margaretha was born in 1663. She died in 1744.
88. **Bauer, Peter.**

### Generation 8

128. **Lay, Hans.**
129. **unknown, Maria.**
130. **Schissler, Joerg.**
132. **Hoffsaess, Anstedt.** Anstedt was born in 1623.
133. **unknown, Barbara.**

136. **unknown, Barbara.**

136. **Wüst, Hanss Georg.** Hanss Georg was born in 1614. He died in 1689.

137. **unknown, Brigitha.** She died in 1672.

138. **Hoffsaess, Anstedt.** Anstedt was born in 1623.

139. **unknown, Barbara.**

## Ahnentafel Report for Allen, Anna Louella

### Generation 1

1. **Allen, Anna Louella.** Anna Louella was born on 1879-02-04 in Meadville, PA. She died on 1941-01-15 in Lemmon, South Dakota. She was buried in 1941 in Lemmon, South Dakota.

### Generation 2

2. **Allen, James Henry.** James Henry was born on 1831-11-29 in New York. He died on 1888-11-29 in Mound City, Campbell, South Dakota, US. He was buried in Mound City, Campbell, South Dakota, US.

3. **Robbins, Lucia Elila.** Lucia Elila was born on 1834-10-17 in Oakland, Livingston, New York. She died on 1910-10-20 in Canby, Clackamas, Oregon.

### Generation 3

4. **Allen, Elisha.** Elisha was born on 1805-04-21 in Fabius, Onondaga, New York. He died on 1832-11-19 in Cortland, New York.

5. **Benedict, Electa Mercy.** Electa Mercy was born on 1802-03-07 in Groton, New York, Tompkins County, NY, New York. She died in 1860 in Meadville, PA.

6. **Robbins, John Edwin Junior.** John Edwin was born on 1801-06-01 in Connecticut. He died on 1877-03-13 in Blooming Valley, Crawford, Pennsylvania.

7. **Warner, Electa.** Electa was born on 1807-07-05 in Parma, Chemung, New York, Chemung, New York. She died on 1863-08-14 in Blooming Valley, Crawford, Pennsylvania.

### Generation 4

8. **Allen, Peter.** Peter was born on 1770-08-28 in Connecticut. He died on 1836-08-08 in Michigan.

9. **Pierce, Roena.** Roena was born on 1781-06-10. She died on 1832-02-09.

10. **Benedict, Enoch.** Enoch was born in 1774 in Tompkins County, NY, New York. He died on 1827-09-10 in Danbury, Fairfield, Connecticut.

11. **Veeder, Mary.** Mary was born in 1778. She died on 1837-01-07 in Groton, NY, New York.

12. **Robbins, John Edwin.** John Edwin was born on 1781-11-04 in Wethersfield, Hartford, Connecticut, US.

13. **Chandler, Elizabeth Corning.** Elizabeth Corning was born in 1780 in Connecticut. She died in Pennsylvania.

14. **Warner, Richard.** Richard was born on 1772-06-21 in Waterbury, Connecticut. He died on 1857-03-25 in Pitcher, New York.

15. **Hickox, Polly.** Polly was born on 1777-03-04 in Waterbury, Connecticut. She died on 1849-09-24 in Pitcher, New York.

### Generation 5

20. **Benedict, Gilbert.** Gilbert was born in 1745 in Danbury, Fairfield, Connecticut. He died on 1827-12-04 in Fabius, Onondaga, New York.

21. **Weed, Mercy.** Mercy was born on 1750-10-09 in Stamford, Connecticut. She died on 1826-08-04 in Onondaga, New York.

22. **Veeder, Nicholas.**

23. **unknown, Eve.**

24. **Robbins, Zebulon.** Zebulon was born on 1744-10-19 in Wethersfield twp, hartford, connecticut, Hartford County, CT, Connecticut. He died on 1840-09-30 in Hartford County, CT, Connecticut.

25. **Goodrich, Lucretia.** Lucretia was born on 1756-06-26 in Hartford County, CT, Connecticut. She died on 1785-04-17 in Hartford County, CT, Connecticut.

28. **Warner, Joseph.** Joseph was born on 1735-10-23 in Waterbury, Connecticut. He died in 1808.

29. **Nichols, Huldah.** Huldah was born on 1747-03-08 in New Haven, Connecticut. She died on 1821-03-04.

30. **Hickox, Gideon.** Gideon was born on 1752-05-04 in Waterbury, Connecticut. He died on 1824-04-25 in Pitcher, New York. He was buried in Pitcher, New York.

31. **Smith, Philena.** Philena was born in 1750 in Fairfield, Connecticut Colony. She died on 1826-11-17 in Chenango County, NY, New York State.

### Generation 6

40. **Benedict, Nathaniel.** Nathaniel was born in 1718. He died in 1806.

41. **Keeler, Hannah.** Hannah was born in 1722. She died in 1795.

42. **Weed, Jonathan.** Jonathan was born on 1711-10-27 in Stamford, Connecticut. He died in 1795.

43. **Drew, Mercy.** Mercy was born in 1713. She died in 1803.

48. **Robbins, Zebulon.** Zebulon was born on 1710-08-02 in Wethersfield, Hartford, Connecticut, US. He died on 1783-04-23 in Wethersfield, Hartford, Connecticut, US.

49. **Morton, Sarah.** Sarah was born on 1711-06-05 in Wethersfield, Hartford, Connecticut, US. She died on 1767-03-30 in Wethersfield, Hartford, Connecticut, US.

50. **Goodrich, Ephraim.** Ephraim was born in 1722. He died in 1771.

51. **unknown, Rebecca.** Rebecca was born in 1727 in Hartford County, CT, Connecticut. She died on 1805-04-08 in Hartford County, CT, Connecticut.

56. **Warner, Obadiah.** Obadiah was born on 1702-02-24 in Connecticut. He died on 1794-09-07.

57. **Lewis, Saran.** Saran was born on 1708-04-29 in Waterbury, Connecticut.
58. **Nichols, Richard.** Richard was born in 1720 in New Haven, Connecticut. He died on 1801-04-25 in New Haven, Connecticut.
59. **Hickox, Elizabeth.** Elizabeth was born on 1720-09-20 in New Haven, Connecticut. She died on 1816-01-21 in New Haven, Connecticut.
60. **Hickox Hickcox, Gideon.** Gideon was born on 1705-09-06 in Waterbury, Connecticut. He died on 1798-04-18 in Waterbury, Connecticut.
61. **Upson, Sarah.** Sarah was born on 1715-07-26 in New Haven, Connecticut. She died on 1809-01-19 in Waterbury, Connecticut.
62. **Smith, Austin.** Austin was born on 1711-04-04 in New Haven, Connecticut.
63. **Smith, Margaret.** Margaret was born on 1711-06-26 in New Haven, Connecticut. She died on 1803-03-27 in Connecticut.

#### Generation 7

80. **Benedict, Nathaniel.** Nathaniel was born in 1680. He died in 1767.
81. **[Missing Surname], Sarah.**
84. **Weed, Jonathan.** Jonathan was born on 1684-04-15 in Connecticut. He died on 1728-12-19.
85. **Ferris, Mary.** Mary was born on 1690-12-12. She died in 1737.
86. **Drew, John.** John was born in 1676 in Plymouth, Massachusetts. He died in 1742.
87. **Green, Elizabeth.** Elizabeth was born in 1682. She died in 1733.
96. **Robbins, Joshua.** Joshua was born on 1681-10-21 in Wethersfield, Hartford, Connecticut, US. He died on 1733-05-30.
97. **Bidwell, Sarah.** Sarah was born on 1681-08-19. She died on 1744-12-03.
98. **Morton, Thomas.** He died on 1740-05-01 in Wethersfield, Hartford, Connecticut, US.
99. **Deming, Comfort.** Comfort was born on 1668-06-05 in Wethersfield twp, hartford, connecticut, Hartford County, CT, Connecticut. She died on 1736-07-13.
112. **Warner, Ephraim.** Ephraim was born in 1670 in Connecticut. He died on 1753-04-30 in Waterbury, Connecticut.
113. **Richards, Esther.** Esther was born on 1673-01-16 in Waterbury, Connecticut. She died on 1762-08-16 in Waterbury, Connecticut.
114. **Lewis, Joseph.** Joseph was born in 1676. He died in 1749.
115. **Andruss, Sarah.** Sarah was born in 1688. She died in 1773.
116. **Nichols, Joseph.** Joseph was born on 1680-11-01 in Fairfield, Connecticut Colony. He died on 1733-03-10 in New Haven, Connecticut.
117. **Wood, Elizabeth.** Elizabeth was born in 1681 in Fairfield, Connecticut Colony. She died on 1767-04-17 in New Haven, Connecticut.
118. **Hickox, Ebenzer.** Ebenzer was born on 1692-10-06 in New Haven, Connecticut. He died on 1774-07-08 in New Haven, Connecticut.
119. **Hine, Esther.** Esther was born on 1694-06-20 in New Haven, Connecticut. She died on 1729-08-28 in New Haven, Connecticut.
120. **Hickox, Samuel.** Samuel was born in 1668. He died on 1713-06-03.
121. **Plumb Plumbe, Elizabeth.** Elizabeth was born in 1669. She died in 1749.
122. **Upson, Stephen.** Stephen was born in 1686. He died in 1777.
123. **Bronson, Sarah.** Sarah was born in 1691. She died in 1748.
124. **Smith, John.** John was born on 1673-09-03 in New Haven, Connecticut. He died in 1768 in New Haven, Connecticut.
125. **Talmadge, Mehitabel.** Mehitabel was born on 1686-12-13 in New Haven, Connecticut. She died on 1750-08-07 in New Haven, Connecticut.
126. **Smith, Samuel.** Samuel was born on 1678-05-14 in New Haven, Connecticut. He died on 1753-08-22 in New Haven, Connecticut.
127. **Cooper, Mary.** Mary was born on 1677-09-04. She died on 1761-06-01.

#### Generation 8

160. **Benedict, Samuel.** Samuel was born in 1645. He died in 1719 in Danbury, Fairfield, Connecticut.
161. **Andrews, Rebecca.** Rebecca was born in 1651 in Danbury, Fairfield, Connecticut. She died in 1719 in Danbury, Fairfield, Connecticut.
168. **Weed, Jonas.**
169. **Holly, Bethia.**
172. **Drew, John.** John was born in 1642. He died in 1721.
173. **Churchhill, Hannah.** Hannah was born in 1649. She died in 1721.
174. **Green, Joseph.** Joseph was born in 1657. He died in 1685.
175. **unknown, Elizabeth.** Elizabeth was born in 1655. She died in 1721.
192. **Robbins, Joshua.** Joshua was born on 1651-10-21 in Wethersfield twp, hartford, connecticut, Hartford County, CT, Connecticut. He died on 1738-12-15 in Wethersfield, Hartford, Connecticut, US.
193. **Butler, Elizabeth.** Elizabeth was born on 1667-08-20 in Hartford County, CT, Connecticut. She died on 1736-04-24 in Hartford County, CT, Connecticut.
194. **Bidwell, John.** John was born in 1641. He died in 1692.
195. **Welles, Sarah.** Sarah was born in 1659. She died in 1708.
196. **Morton, Richard.**
197. **Edwards, Ruth.** Ruth was born in 1643. She died on 1714-12-31 in Massachusetts.
198. **Deming, Jonathan.** He died on 1799-01-08.
199. **Graves, Sarah.** She died on 1668-06-05 in Wethersfield, Hartford, Connecticut, US.
224. **Warner, John.** John was born in 1639 in Hartford County, CT, Connecticut. He died on 1707-03-01 in Hartford County, CT, Connecticut.



225. **Howard, Margaret.** Margaret was born in 1652. She died on 1751-03-03.
226. **Richards, Obadiah.** Obadiah was born in 1646. He died in 1702.
227. **Andrews, Hannah.** Hannah was born in 1647. She died in 1725.
228. **Lewis, Joseph.**
229. **Case, Elisabeth.**
230. **Andruss Andrews, Abraham.**
231. **Carrington, Rebecca.**
232. **Nichols, Isaac.** Isaac was born on 1654-03-12. He died in 1690.
233. **Baldwin, Mary.** Mary was born in 1653. She died in 1725.
236. **Hickox, Samuel.** Samuel was born in 1668. He died on 1713-06-03.
237. **Plumb Plumbe, Elizabeth.** Elizabeth was born in 1669. She died in 1749.
238. **Hine, Thomas.** Thomas was born on 1653-10-21 in New Haven, Connecticut. He died on 1742-01-17 in New Haven, Connecticut.
239. **Bristol, Hannah.** Hannah was born on 1663-12-10 in New Haven, Connecticut. She died in 1741 in New Haven, Connecticut.
240. **Hickox, Samuel.** Samuel was born in 1643. He died in 1695.
241. **Upson, Hannah.** Hannah was born on 1646-05-25 in Connecticut. She died on 1707-07-20 in Waterbury, Connecticut.
242. **Plumb, John.** John was born in 1646. He died in 1728.
243. **Norton, Elizabeth.** Elizabeth was born in 1645. She died in 1712.
244. **Upson, Stephen.** Stephen was born in 1650. He died in 1735.
245. **Lee, Mary Hart.** Mary Hart was born in 1664. She died in 1716.
246. **Bronson, Isaac.** Isaac was born in 1645. He died in 1719.
247. **Root, Mary.** Mary was born on 1650-08-06 in Hartford County, CT, Connecticut. She died on 1701-06-13.
248. **Smith, John.** John was born on 1647-04-18 in New Haven, Connecticut. He died on 1711-12-19 in New Haven, Connecticut.
249. **Winston, Grace.** Grace was born on 1654-04-21 in New Haven, Connecticut. She died on 1695-10-22 in New Haven, Connecticut.
250. **Talmadge, Enos.** Enos was born on 1656-10-04 in New Haven, Connecticut. He died on 1690-02-09 in New Haven, Connecticut.
251. **Yale, Hannah.** Hannah was born on 1662-07-06 in New Haven, Connecticut. She died on 1744-02-10 in New Haven, Connecticut.
252. **Smith, Samuel.** Samuel was born on 1651-12-04. He died on 1726-09-18.
253. **Lamberton, Obedience.** Obedience was born on 1643-02-09. She died on 1734-03-29.
254. **Cooper, John Junior.** John was born on 1642-05-28 in New Haven, Connecticut. He was baptized on 1642-05-28 in New Haven, Connecticut. He died in 1703 in New Haven, Connecticut.
255. **Talman, Mary.** Mary was born on 1642-04-24 in New Haven, Connecticut.

### Backlinks:

[281connections Wiki:South Dakota Families:Loy-Allen](#)

Created with Zim-wiki & the Ecodiv-responsive template





**281connections Wiki**

**About**

**Copyright(left)**

**Education**

**Privacy**

**South Dakota Families**

**Bates-Moodie**

**Loy-Allen**

**Ahnentafel**

**AncestralCollapsible**

**FamilyGroup**

**Fan**

**Snyder Family Research**

**Tracing mtDNA**

**Memorials**

**Mysteries**

**Rombs-Kessler**

**Thompson-Olsen**

**Texas Families**



# Family Group Chart

--

<b>Family Group Report</b>		
<b>Husband: Loy, Samuel (I0026)</b>		
Birth	date conflicts with headstone, but syncs with other public records. County unknown.	
	1859-01-06	Ohio
Death	see death certificate	
	1920-10-28	Adams, North Dakota
Father	Loy Lay, Johann Georg (I0079)	
Mother	Snyder, Susannah (I0373)	
<b>Marriage (F0008):</b>		
Marriage	1895-12-25	Mound City, South Dakota
<b>Wife: Allen, Anna Louella (I0024)</b>		
Birth	1879-02-04	Meadville, PA
Death	Bismark - actually died in Bismark hospital of leukemia	
	1941-01-15	Lemmon, South Dakota
Father	Allen, James Henry (I0027)	
Mother	Robbins, Lucia Elila (I0025)	
<b>Children</b>		
<b>1F</b>	<b>Loy, Ruth Irene (I0074)</b>	
	Birth	1896-10-02 Campbell, South Dakota
	Death	1958-11-06 Lemmon, South Dakota
	Spouse	Scoular, William Thomas (I0203) (F0042)
	Marriage	1918-10-15 Perkins, South Dakota
<b>2M</b>	<b>Loy, Guy Elmer (I0075)</b>	
	Birth	1898-01-08 Campbell, South Dakota
	Death	1923-09-03 Campbell, South Dakota
	Spouse	Thompson, Agnes Georgann (I0204) (F0043)
	Marriage	1922-06-28 Walworth, South Dakota
<b>3F</b>	<b>Loy, Marian Evelyn (I0013)</b>	
	Birth	1900-05-06 Campbell, South Dakota
	Death	1995-10-30 Mound City, Campbell, South Dakota, US
	Spouse	Bates, Harry C. (I0012) (F0003)
	Marriage	1921-04-27 Lemmon, South Dakota
	Spouse	Snorteland, Christ (I3636) (F0785)
	Marriage	1956
<b>4M</b>	<b>Loy, Arlo Wilmot (I0076)</b>	
	Birth	1902-11-23 Campbell, South Dakota
	Death	1906-01-04 Campbell, South Dakota
<b>5M</b>	<b>Loy, Ralph Samuel (I0077)</b>	
	Birth	1906-09-08 Lyman, South Dakota
	Death	1991-12-31 Mount Vernon, Skagit, Washington
	Spouse	Thompson, Agnes Georgann (I0204) (F0044)
<b>6M</b>	<b>Loy, Howard Allen (I0078)</b>	
	Birth	1910-05-05 Campbell, South Dakota
	Death	1972-02-15 Sandpoint, Bonner, Idaho
	Spouse	Peterson, Ina (I0205) (F0045)

**Backlinks:**

[281connections Wiki:South Dakota Families:Loy-Allen](#)



## 281connections Wiki

**About**

**Copyright(left)**

**Education**

**Privacy**

**South Dakota Families**

**Bates-Moodie**

**Loy-Allen**

**Ahnentafel**

**AncestralCollapsible**

**FamilyGroup**

**Fan**

**DynamicFan**

**Snyder Family Research**

**Tracing mtDNA**

**Memorials**

**Mysteries**

**Rombs-Kessler**

**Thompson-Olsen**

**Texas Families**

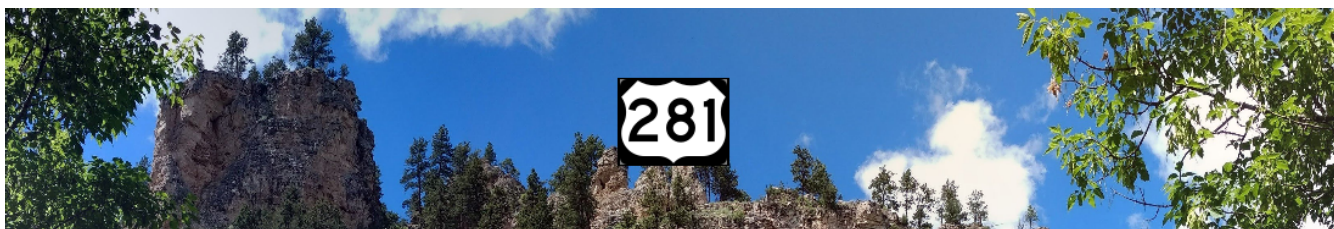

## Fan (pedigree)

Following is a static representation of a pedigree chart for one of the children of Anna and Sam. Use this [link](#) to navigate to a similar dynamic chart.

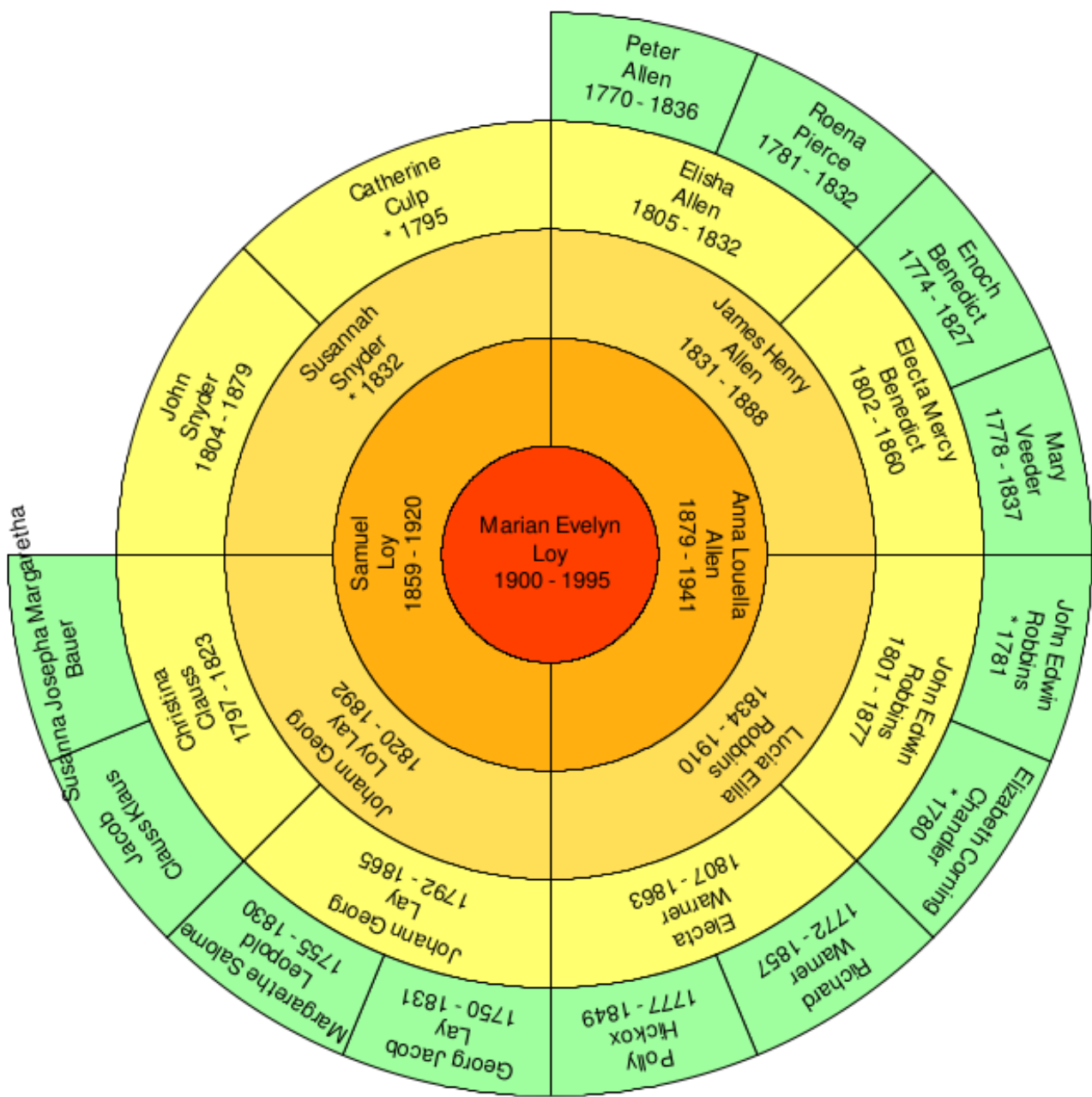

**Backlinks:**

[281connections Wiki:South Dakota Families:Loy-Allen](#)

Created with Zim-wiki & the Ecodiv-responsive template



## 281connections Wiki

**About**

**Copyright(left)**

**Education**

**Privacy**

**South Dakota Families**

**Bates-Moodie**

**Loy-Allen**

**Ahnentafel**

**AncestralCollapsible**

**FamilyGroup**

**Fan**

**Snyder Family Research**

**Tracing mtDNA**

**Memorials**

**Mysteries**

**Rombs-Kessler**

**Thompson-Olsen**

**Texas Families**

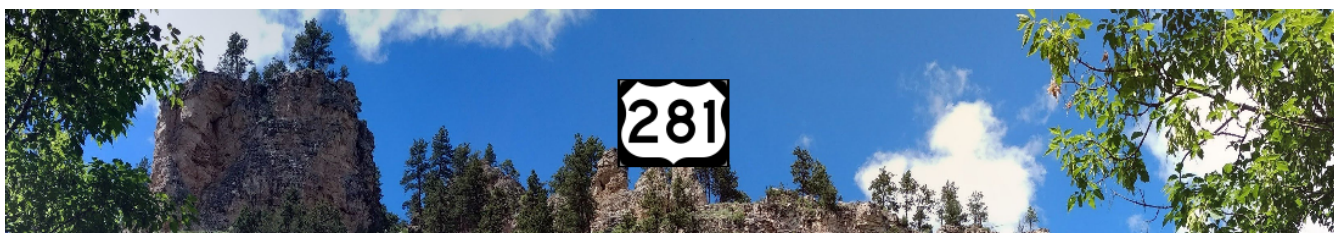

# Snyder Family Research

Only one concrete bit of evidence exists for the parents of Susannah Snyder, my 2nd great grandmother. That evidence consists of the 1850 Federal Census for Marion Co., OH. See <https://www.familysearch.org/ark:/61903/1:1:MXQL-MV2> . It shows her parents (John and Catherine), two sisters (Elizabeth and Martha), and a brother (George) as follows.

<u>Household</u>	<u>Sex</u>	<u>Age</u>	<u>Birthplace</u>
John Snyder	M	46	Pennsylvania
Catharine Snyder	F	55	Pennsylvania
Susanna Snyder	F	18	Pennsylvania
Elizabeth Snyder	F	16	Ohio
George Snyder	M	15	Ohio
Martha Snyder	F	9	Ohio

Tracing John and Catherine back to PA has proved to be very difficult, but I have made some headway by using DNA matching technology and by investigating two other families with similar characteristics who lived nearby in 1850. The other two

families appear on the same page of the 1850 census. They are the families of William Selanders and Simon Culp. Accompanying documents summarize my investigations into [Culp](#) and [Selanders](#) families in OH, PA, and elsewhere.

These investigations lead me to suspect that Susannah's mother's maiden name was likely Catherine Culp. She was likely a sister to Simon Culp and his two brothers, Andrew and Samuel. Research into PA records shows a close association between Culp and Selanders families in Cumberland Co., PA. Unfortunately, my investigations have not yielded the same kind of evidence that would demonstrate how Snyder people relate to the Culp and Selanders families. You can find the details of my research into Snyder families in OH and PA in this [document](#).

My proposal regarding the identity of Catherine Snyder can be found [here](#).

The experience of doing this research has resulted in a [presentation](#) on the DNA matching techniques used as well as the "oblique" traditional research. See the [Education](#) section of this web site.

Until a well-defined solution is found, I have the following proposed solution involving the family of Phillip and Barbara Snyder, who lived near New Kingstown in Cumberland Co., PA. ->

*"The elder Phillip Snyder in the east settled near New Kingstown. His wife's name was Barbara. They may be connected somehow with the western Phillip and George Snyder clan. The western clan may have had an association with a Simon Culp who could be the father of Simon Culp (b.~1801).*

*The eastern elder Phillip had a family whose members were baptized in the Lutheran church in New Kingstown, near where the family had various tracts of land. The first son was also named Phillip, and his son Johann Jacob born in 1804 could be the person who appears as John Snyder in the 1850 OH census.*

*Nearby to the Snyder family (within 5-10 miles) can be found families associated with Valentine Selanders. And a younger Simon Culp is clearly associated with these families. Perhaps a sister of Simon's named Catherine married John Snyder. Many of these families can be found in OH in 1850. There may be an association with Mennonite or Church of the Brethren Churches. "*



## A Speculative Family Tree

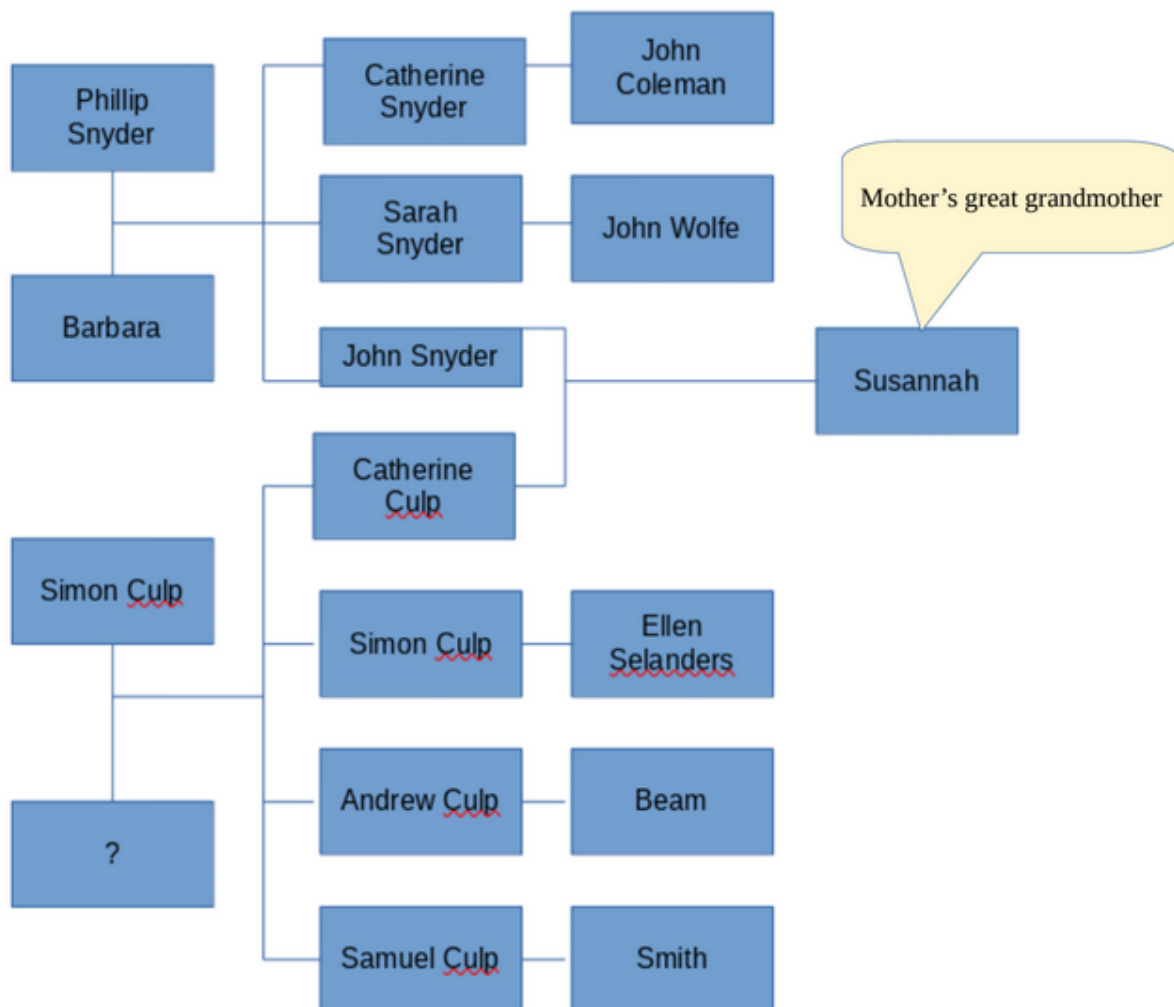

The proposed migration route from Cumberland Co., PA, to Marion Co., OH, involves use of the National Road in about 1833. Black arrows in the figure that follows show points of entrance to and exit from the National Road.



*The National Road*, by Philip D. Jordan. Indianapolis: Bobbs-Merrill Co., 1948. 442 pp. Hardcover. Illustrations, photographs, map, source notes.

Some day perhaps we will know if this conjecture is close to the truth or not.

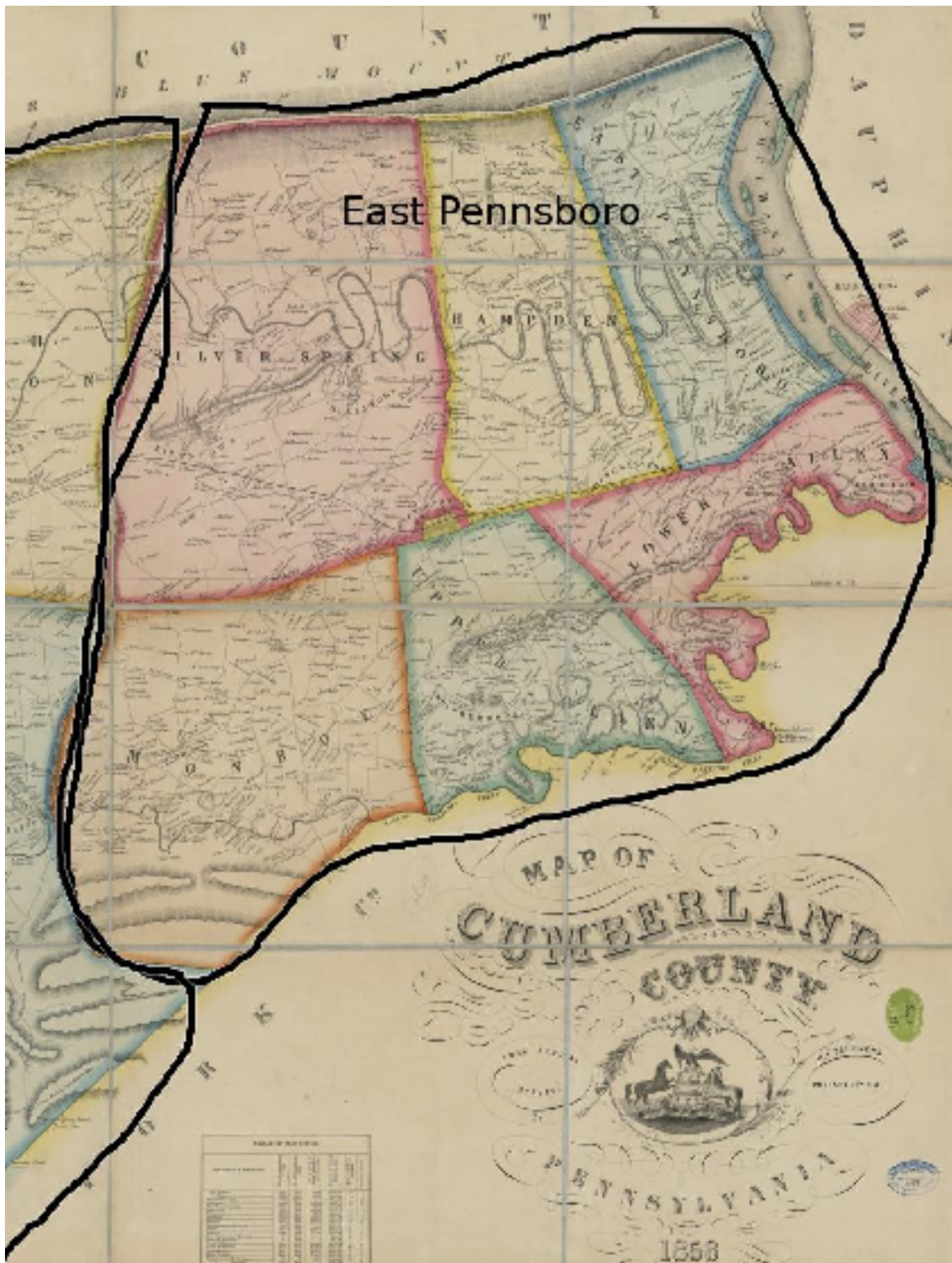

**Backlinks:**

5.0-Snyder Family Research

[281connections Wiki>About](#)

[281connections Wiki:South Dakota Families:Loy-Allen](#)

Created with [Zim-wiki](#) & the [Ecodiv-responsive template](#)

# The Case for Catharine Culp

## Table of Contents

The Problem (Introduction).....	2
Seeking a Solution.....	2
Conventional Research.....	3
Direct Approach.....	3
Indirect Approach.....	4
DNA Matching (autosomal).....	7
Final Proposed Solution.....	9
Future Work.....	9
End Notes.....	9



# The Case for Catharine Culp

## The Problem (Introduction)

In the middle of the 19<sup>th</sup> century, much of Marion Co., OH, was being and had recently been populated by a significant number of people from Pennsylvania as well as from what is now western Germany.<sup>i</sup> This research note is about an effort to trace the ancestors of an example germanic family that appears in the 1850 Federal census in Waldo Township in Marion Co. The research is an example of how the combination of DNA analysis and an oblique approach to conventional records can yield useful information, in this case the identity of the mother in this family.

The family in question is headed by John and Catharine Snyder. An image of the entry in the 1850 census follows.<sup>ii</sup> Because of the poor image quality, transcriptions of names are shown as well.



Household	Sex	Age	Birthplace
John Snyder	M	46	Pennsylvania
Catharine Snyder	F	55	Pennsylvania
Susanna Snyder	F	18	Pennsylvania
Elizabeth Snyder	F	16	Ohio
George Snyder	M	15	Ohio
Martha Snyder	F	9	Ohio

Figure 1: 1850 Federal Census for Marion Co., OH

The heads of this family are my maternal third great-grandparents by way of their daughter Susanna. In spite of few definitive conventional records, I believe that there is enough evidence to suggest that Catherine was born Catherine Culp.

## Seeking a Solution

In order to find out more about this family, I used a combination of conventional research as well as DNA matching techniques. Conventional records about the family have been sparse and hard to find. Consequently conventional research relied heavily on analysis of information about their neighbors in 1850. Augmenting this with DNA analysis it became possible to identify Catharine more fully with reasonable certainty.

# The Case for Catharine Culp

## Conventional Research

### Direct Approach

An attempt was made to follow the family forward and backward in time in OH. Because of the birth years of the children, records in OH were searched from 1830 – 1870. The following sources were explored. Note that sources in Marion and Delaware Counties were employed. This is because governance responsibility for the (Waldo Twp) area in question changed from Delaware Co. to Marion Co. in 1848.<sup>iii</sup>

- Marion County Genealogical Society; Delaware Historical Society
- Marion Library
- Newspaper articles
- Graves – online, genealogical society information, phone; Twp trustees
- Church records – phone
- Wills/Court records
- Property transactions (U.S. Military District); online & OGS.org

The results of this work were as follows.

- Nothing was found regarding the family in OH prior to 1850. There were a few possibilities in the census enumerations, but nothing that clearly matched.
- There were no birth records for the children born in OH.
- There were no land transaction records for the couple.
- There were no death/burial records for either parent (John or Catharine).
- The marriage record of daughter Elizabeth to Jacob Boyer in 1859 was found, but no one other than the groom was mentioned.<sup>iv</sup> She and her family were followed forward in time with nothing to hint at the identity of her parents.
- It is likely that son George joined the Union Army and died in the war. He was not found in records after the war, but likely records of his enlistment and death were found. No hints about parents.<sup>v</sup>
- Daughter Martha does not clearly appear in any records after the 1850 census.
- Daughter Susanna married John Loy (a.k.a. Johann Georg Lay) in 1857, has two children, and disappears from the records after the 1860 census. Her husband remarries in 1863. (His 4<sup>th</sup> - 5<sup>th</sup> marriage!)<sup>vi</sup>

So, the direct approach yielded nothing useful about Catharine (and John) Snyder.

# The Case for Catharine Culp

## Indirect Approach

Having failed at the direct approach, another approach based on finding interesting families in the 1850 census for Waldo Twp was tried. “Interesting” means families with similar characteristics to those of the family of John and Catharine Snyder. Specifically . . .

- Parents born in PA prior to about 1810.
- First children born in PA.
- Subsequent children born in OH.
- Implied migration to OH in 1832-1834.
- Preference for Germanic names.
- Proximity to the Snyder family in Waldo Twp, Marion County, OH, in 1850.

Two families immediately suggested themselves from the same page on the 1850 census that showed the Snyder family.<sup>vii</sup> The surnames for these families were Selanders and Culp as shown below.

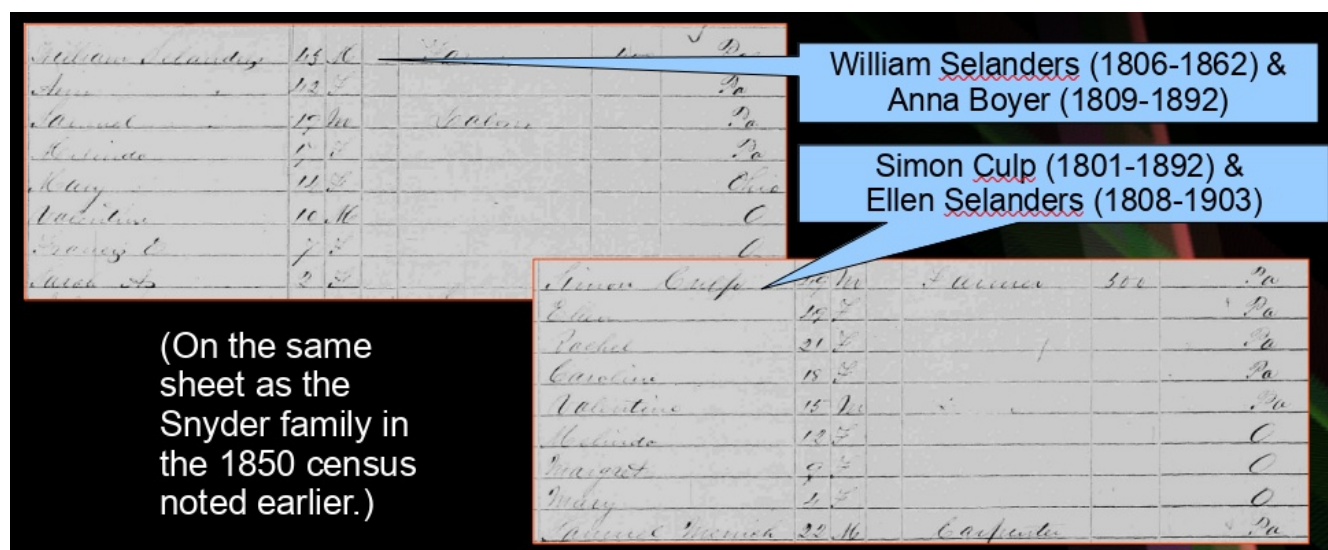

Figure 2: 1850 Federal Census for Marion Co., OH

A little research revealed that the wife of Simon Culp was a sister of William Selanders as well as the fact that both Simon and William had lived close to each other in Cumberland Co., PA. So, research was focused on Selanders and Culp people in Cumberland County, PA. Two research reports resulted from the subsequent work.<sup>viii</sup> Some select details from these reports follow.

Here are some examples of what was found regarding Selanders people. - Members of the family of William Selanders b. about 1806-1809 (PA) and Anna Boyer b.1809 (Cumberland Co., PA) follow. The



# The Case for Catharine Culp

history of each child was followed for hints about the origins of the parents. No new information was found.

- Alvina b.1829 in PA
- Samuel b.1831 in PA
- Malinda b. 1833 in PA
- Mary b. 1836 in OH
- Valentine b. 1840 in OH
- Frances b. 1843 in OH
- Sarah b. 1848 in OH

William migrated with parents (Valentine & mother Rachel Bruce) & siblings (Samuel, Ellen, and Malinda) to OH in about 1833-1834.<sup>ix</sup>

Here are some examples of what was found regarding Culp people. - The members of the family of Simon Culp b.1801 (PA) and Ellen Selanders b.1806 (PA) follow. The history of each child was followed for hints about the origins of the parents. No new information was found.

- A record shows that Simon & Ellen were married in 1828 in Silver Spring Twp, Cumberland Co., PA. Their children were . . .
  - Rachel b.1829 in PA
  - Caroline b.1831 in PA
  - John Valentine b. 1835 in PA
  - Malinda b.1838 in OH
  - Margaret b.1839 in OH
  - Mary Jane b.1844 OH

Simon had two brothers – Andrew and Samuel, who also passed through OH on their way to other places farther west.

The 1830 census puts both Valentine Selanders & Simon Culp in Silver Spring Twp in Cumberland Co., PA.<sup>x</sup>

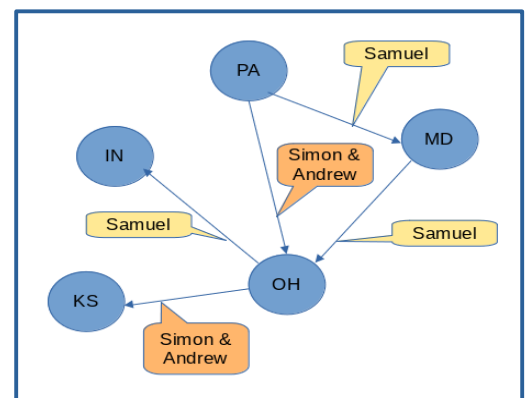

Figure 3: Culp Brothers

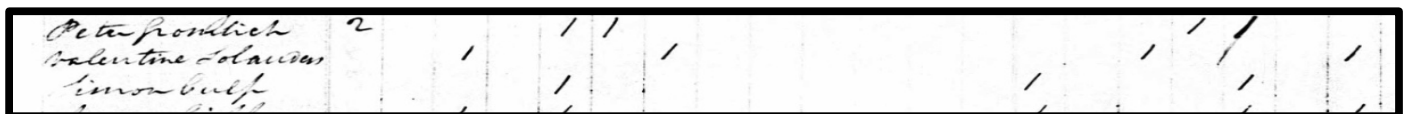

Figure 4: 1830 Federal Census for Cumberland Co., PA

# The Case for Catharine Culp

A summary of results of the indirect research includes the following.

- The ancestors in PA of the Snyder family are still undefined. There were many possibilities based on the Snyder surname and no way to choose the right one(s).
- Culp – hints of Anabaptist religion; only obvious tie is between Culp & Selanders families
- Selanders – interesting family, Evangelisch
- In both cases, however, I now had lots of information about brothers, sisters, descendants in Culp and Selanders families.
- Many bits of information point to Cumberland County, PA.

# The Case for Catharine Culp

## DNA Matching (autosomal)

Having made little progress using conventional records, DNA matching was next employed. I chose to use my mother's DNA since this problem only involved my maternal line. My mother's DNA had been submitted to these companies.

- 23andme - There were about  $61 \times 25 = 1525$  matches at 23andme.
- FTDNA – There were 5113 matches at FTDNA.
- Ancestry.com – There were hundreds of matches with trees at ancestry.com

In order to make this a tractable problem, a way needed to be chosen to focus and find the hidden gems. I employed a method somewhat similar to that used in the Leeds method.<sup>xi</sup> (i.e., limit the range of matches considered to focus on more distant matches) This meant looking at some relatively weak signals. The shared cM Project Tool provided guidance in this regard, and I chose to look at matches in which the amount of shared DNA was approximately 25-30 cM. Here is a picture of the tool with an entered value of 25 cM and names filled in for my mother's ancestors.<sup>xii</sup>

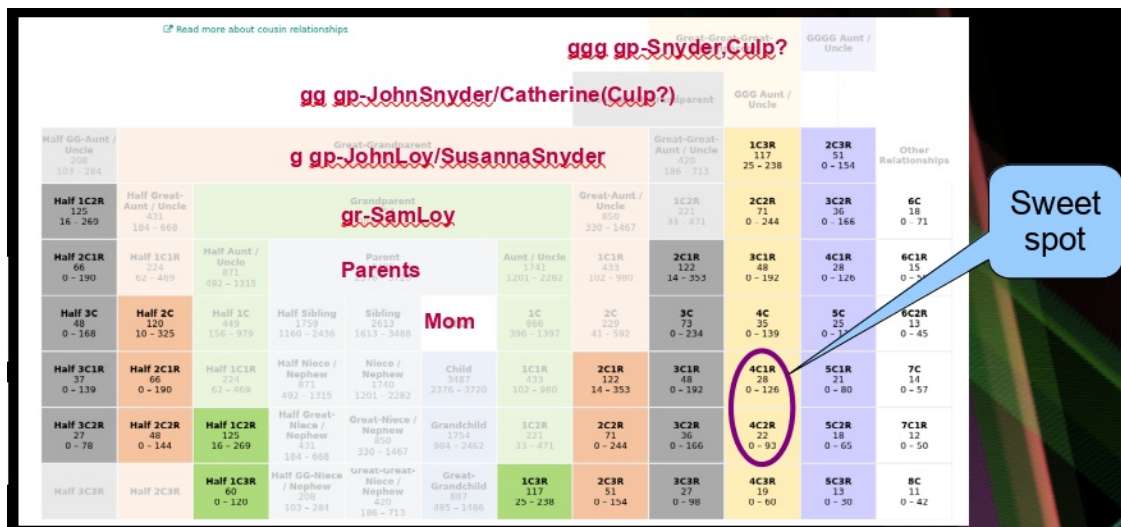

Figure 5: Example Output of Shared cM Tool

The “sweet spot” identifies the range where I hoped to find matches with people of my generation who are descended from my mother's 3<sup>rd</sup> great grandparents.

At ancestry.com I looked for people with a DNA match in the right range and who mentioned Selanders in their trees. Then the same process was used to look for matches that mentioned the name Culp. This revealed three candidates with ties to Culp family members – namely the three brothers mentioned above (Simon, Andrew, and Samuel). Each match traced to a different Culp brother. These matches were in the range of 22-34 cM!



# The Case for Catharine Culp

At 23andme.com, the same process yielded three matches again when the Culp surname was used. Communication with these three individuals has been tried without success so no detailed ancestor matching information is available.

At familytreedna.com the process yielded just one match, and it turned out to be a duplicate of one of those identified at ancestry.com.

When the Snyder surname was used at ancestry.com, one match of interest appeared, but it is not relevant to the search for Catharine since common ancestors could not be identified. Interestingly, the match does point to a Sarah Snyder of Cumberland Co., who was born there in 1797 and died there in 1863. It would have certainly been nice if this match had led to John Snyder in Cumberland Co. More work on this needs to be done.

In a separate effort, using the tree creation tools at 23andme, a tree was constructed for my mother's matches. Carefully following the maternal line of descendants from Susanna Snyder to daughter Christina to Helen Moreo to Viola Lause to Winona Garmhausen, it appears that Susanna's mtDNA haplogroup is T2F1. This must be the haplogroup for Catharine as well, and this information may be useful at some point.

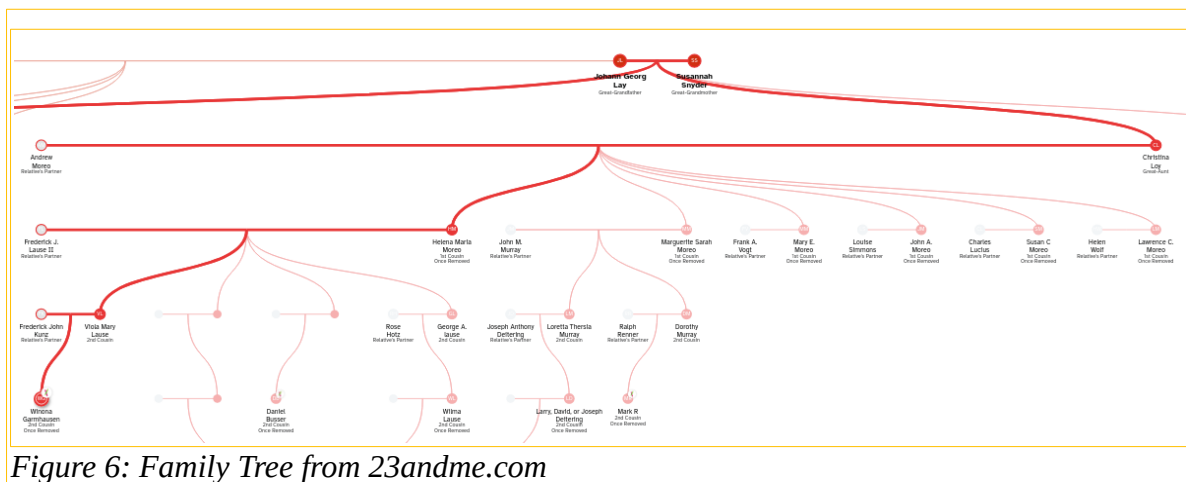

The conclusions that were drawn from the DNA matching work are the following.

- No matches related solely to the Selanders name were found.
- Mom appears to be related to each Culp brother.
- Catharine Snyder may very well have been born Catharine Culp.
- Indirection pushed the research forward!

# The Case for Catharine Culp

## Final Proposed Solution

My proposal based on all information above is that the woman in the 1850 census enumeration and identified as Catharine was born Catharine Culp, the sister to Simon, Samuel, and Andrew Culp. She was born in PA in the early 1790s, possibly in Cumberland Co., PA. Furthermore, her mtDNA haplogroup is T2F1.

## Future Work

It is necessary to keep on working to prove/disprove the proposal. For example, the Historical Society of Cumberland Co. PA may have more information. (Request has already been sent.) Maybe a marriage record for John and Catharine can be found in Cumberland Co. - or even a birth record for Susanna. The former might also lead to information about John's ancestors.

It is possible that Catharine's birth family is shown in the 1800 and 1810 Federal Census as follows. This is based on a hint from another researcher that the father of brother's Simon, Andrew, and Samuel Culp was also named Simon. Perhaps this can be proven/dis-proven based on land, tax, or church records.

1800:<sup>xiii</sup>



Mr. Harvey	"	2	"	"	1	1	"	"	"	"	"	"
Simon Culp	2	"	"	1	"	1	"	"	"	1	"	"
Saml. Bear	1	"	"	1	"	1	"	"	"	1	"	"

1810:<sup>xiv</sup>



Simon Culp	4	2	1	1	3	1	1	1	1	1	1	1
------------	---	---	---	---	---	---	---	---	---	---	---	---

Mennonite records may be useful in the event that Catharine's family was associated with this group.

Continue exploring in Marion and Delaware Counties (OH) for more information.

Keep investigating DNA matches for clues.

## End Notes

- i See for example *The Settlement of the Old Northwest: Ethnic Pluralism in a Featureless Plain*; Author(s): Robert P. Swierenga; Source: *Journal of the Early Republic* , Spring, 1989, Vol. 9, No. 1 (Spring, 1989), pp. 73-105; Published by: University of Pennsylvania Press on behalf of the Society for Historians of the Early American Republic; Stable URL: <https://www.jstor.org/stable/3123525> . Figure 2 is a good summary.
- ii 1850 Federal Census: The image for Waldo Twp in Marion Co., OH, can be found at [familysearch.org](http://familysearch.org) using this link. - <https://www.familysearch.org/ark:/61903/1:1:MXQL-MV2>
- iii See for example *The History of Marion County, OH*, published in 1883 by Leggett, Conaway & Co. of Chicago, p. 296.
- iv An image of the marriage record for Elizabeth can be found at <https://www.familysearch.org/ark:/61903/1:1:XZDK-L2G> .

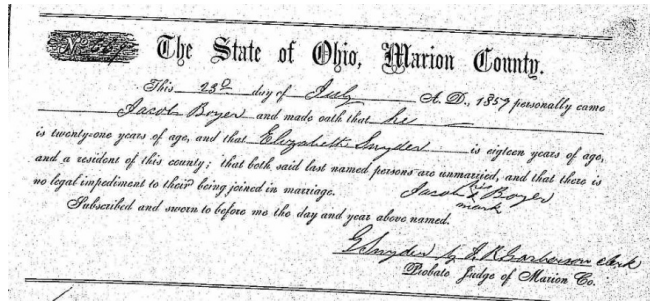

- v The following is a likely secondary record of George's involvement in the Civil War. See page 126 of the *Atlas of Marion County Ohio*, published in 1878 by Harrison, Sutton, and Hare in Philadelphia. Available from the Ohio Genealogical Society using this url. -

[https://www.ogs.org/wp-content/uploads/resources/Active\\_1\\_of\\_4/mss00048f00034\\_oh\\_marion\\_civilwar\\_hardesty.pdf](https://www.ogs.org/wp-content/uploads/resources/Active_1_of_4/mss00048f00034_oh_marion_civilwar_hardesty.pdf)

Schnider, John G. . .	"	D	"	"	"	Captured, Gettysburg.
Snyder, George. . . .	"	H	4th	"	April, '61 . . . .	Sept. 25, '62.
	"			"	Sept. 1861	June 1865.

- vi For full information about the family of John Loy and Susanna Snyder as well as John's other families, see the following unpublished report - [https://281connections.us/281connections\\_Wiki/South\\_Dakota\\_Families/Loy-Allen/LifeAndTimesOfJohannLay.pdf](https://281connections.us/281connections_Wiki/South_Dakota_Families/Loy-Allen/LifeAndTimesOfJohannLay.pdf) . An image of Susanna's marriage record can be found at <https://www.familysearch.org/ark:/61903/1:1:XZDK-FFR> .

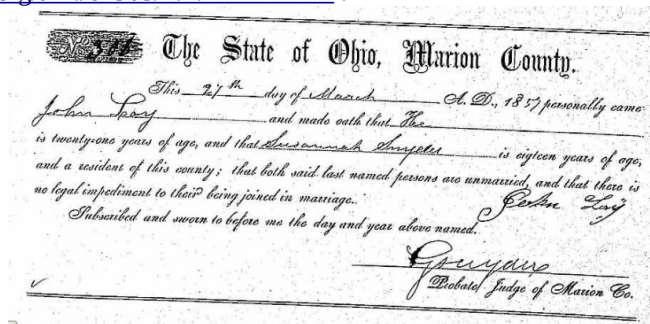

- vii Refer to note ii above.
- viii Unpublished reports with source citations: The research report related to Culp ancestors can be found at [https://281connections.us/281connections\\_Wiki/South\\_Dakota\\_Families/Loy-Allen/Snyder\\_Family\\_Research/SimonCulp-EllenSelenders.pdf](https://281connections.us/281connections_Wiki/South_Dakota_Families/Loy-Allen/Snyder_Family_Research/SimonCulp-EllenSelenders.pdf) . The report on Selandereers ancestors can be found at [https://281connections.us/281connections\\_Wiki/South\\_Dakota\\_Families/Loy-Allen/Snyder\\_Family\\_Research/ChristianSelanderSr-children.pdf](https://281connections.us/281connections_Wiki/South_Dakota_Families/Loy-Allen/Snyder_Family_Research/ChristianSelanderSr-children.pdf) . A similar report on Snyder family research can be found at [https://281connections.us/281connections\\_Wiki/South\\_Dakota\\_Families/Loy-Allen/Snyder\\_Family\\_Research/JohnSnyder-Clues.pdf](https://281connections.us/281connections_Wiki/South_Dakota_Families/Loy-Allen/Snyder_Family_Research/JohnSnyder-Clues.pdf) .
- ix See the Selanders research report in note viii above.
- x See the Culp research report in note viii above.
- xi Leeds method: <https://www.danaleeds.com/the-leeds-method/>
- xii The Shared cM Project Tool can be found at <https://dnainter.com/tools/sharedcmv4> .
- xiii 1800 Federal Census for Cumberland Co., PA, showing Simon Culp: <https://www.familysearch.org/ark:/61903/1:1:XHRD-GRT>
- xiv 1810 Federal Census for Cumberland Co., PA, showing Simon Culp: <https://www.familysearch.org/ark:/61903/1:1:XH2K-TWV>

# Children of Johann Christian & Anna Maria Selanders

## Table of Contents

1	Johann Christian & Anna Maria (Zimmer) Selanders.....	3
1.1	Immigration (1774).....	4
1.2	Census & Tax Records.....	4
1.2.1	1788 tax list for West Pennsboro.....	4
1.2.2	1793 & 1800 Septennial Census for PA.....	5
1.2.3	1798 Tax List.....	5
1.3	Death(s).....	6
1.4	Lists of Children.....	7
2	Elisabeth (1775-1855).....	9
2.1	Birth.....	9
2.2	Marriage.....	9
2.3	Children.....	9
2.4	1850 Census (Holmes Co., OH).....	10
2.5	1840 Census (Holmes Co., OH).....	11
3	Christian (1775/1780?-1804).....	12
3.1	Birth (1780?).....	12
3.2	Marriage (1801) and Children.....	12
3.3	Other PA Evidence (1800-1826).....	14
3.4	Death (~11/1804).....	15
4	Johannes (1780-1791).....	17
5	Valentine (1783?-1868).....	18
5.1	Birth (1783?).....	18
5.2	Marriage (1804-1805?) to Rachel and Subsequent Children.....	18
5.2.1	William (1806?-1862).....	19
5.2.2	Samuel Adam (1817-1871?).....	22
5.2.3	Ellen (Eleanor) (1806-9? - 1903).....	22
5.2.4	Malinda (1818-1901).....	25
5.3	1810 Census (E. Pennsboro Twp, Cumberland Co., PA).....	26
5.4	1820 Census (E. Pennsboro Twp, Cumberland Co., PA).....	26
5.5	1830 Census (Silver Spring Twp, Cumberland Co., PA).....	26
5.6	1850 Census (Marion Co., OH).....	26
5.7	1860 Census (Marion Co., OH).....	27
5.8	Death (1868 in Waldo, OH).....	27
6	Francis (1789-1868).....	28
6.1	Birth (1786-1789).....	28
6.2	Marriage 11/29/1814.....	28
6.3	Children.....	29
6.3.1	Catherine (1819-1878).....	29
6.3.2	William (1821-1899).....	30
6.3.3	Elizabeth (1822-1911).....	30
6.3.4	Daniel (1827-1916).....	30

# Children of Johann Christian & Anna Maria Selanders

6.3.5	Ann Jane (1830-1924).....	30
6.3.6	George Augustus (1838-1911).....	30
6.4	Census Enumerations.....	31
6.4.1	1830 Census (Allen Twp, Cumberland Co.).....	31
6.4.2	1840 Census (?).....	31
6.4.3	1850 Census (Upper Allen Twp, Cumberland Co.).....	31
6.4.4	1860 census (Rock Island, Illinois).....	32
6.5	Death (1868 in Rock Island).....	32
7	Catherine (1795-1880).....	33
7.1	Birth.....	33
7.2	Marriage (1816 – Silver Spring TWP, Cumberland Co., PA).....	33
7.3	Children.....	34
7.3.1	Mary Ann (1817-1900).....	34
7.3.2	John (1818-1899).....	34
7.3.3	Elizabeth (1823-1904).....	34
7.3.4	James (1825-1905).....	35
7.3.5	Sarah (1828-1919).....	35
7.3.6	Henry (1830-1855?).....	35
7.3.7	Francis (1834-1855).....	35
7.4	Census Enumerations.....	36
7.4.1	1800 Census (Allen Twp, Cumberland Co., PA).....	36
7.4.2	1830 (Allen Twp, Cumberland Co., PA).....	36
7.4.3	1840 (Allen Twp, Cumberland Co., PA).....	36
7.4.4	1850 Census (Holmes Co, OH).....	37
7.4.5	1860 Census (Holmes Co., OH).....	37
7.4.6	1870 Census (Holmes Co., OH).....	38
7.5	Death (1880).....	38
8	Analysis: 1850 and 1860 Census for Marion Co., OH.....	39
8.1	Ellen Selanders and Simon Culp.....	40
8.2	William Selanders and Ann (Boyer).....	42
8.3	Samuel A. Selanders and Sarah (Koph).....	43
8.4	Malinda Selanders and Sylvester (Boyd).....	44
8.5	Suspicious Family of Henry and Susan Zowlander.....	45
8.6	Summary Diagram (Tree).....	46



# Children of Johann Christian & Anna Maria Selanders

## 1 Johann Christian & Anna Maria (Zimmer) Selanders

I have found some source information about Christian (elder), but not much about his wife (Anna). Anna Maria's maiden name may have been Zimmer (or Jost/Yost according to some information on ancestry.com). Some people claim that the elder Christian was born in the village of Traben in the Rheinland-Palatinate on 1/5/1754, with a marriage on 6/13/1773 in the same village to Anna Maria. See image 74 of <https://www.ancestry.com/discoveryui-content/view/319431:61131> for the record of the marriage. This is why I have used the Zimmer name here, but the writing leaves much to be desired.

Handwritten text in German, likely a marriage record. The text is written in cursive and includes names and dates. The visible text reads: "Johann Christian Selander wif. Johann Valentia Selander... und Anna Maria wif. Johann Christian Selander... Copuliert den 15ten Junii. A."

Johann Christian's father probably was married at Traben-Trarbach on 4/14/1750 as well. See image 17 of <https://www.ancestry.com/discoveryui-content/view/900321959:61131>. The given name of Valentine is probably significant as it recurs among descendants.

Handwritten text in German, dated 1750. The text is written in cursive and includes names and dates. The visible text reads: "1750. Johann Valentia Xilandra, im abgedauerten Holländischer da... wif. Johann... Copuliert den 14ten April." The text is partially obscured by a vertical line on the right side.

# Children of Johann Christian & Anna Maria Selanders

## 1.1 Immigration (1774)

One ancestry entry refers to their immigration in 1774 to Philadelphia on the Minerva from London. They were 22 & 28 years old at the time, meaning that they were born between 1746-1752. No mention is made of children in the record. Were they “indentured servants”? See

<https://www.ancestry.com/family-tree/person/tree/9623519/person/332345515677/facts> . And (requires Hennepin County Library login before using) <https://go-gale-com.ezproxy.hclib.org/ps/bobIndex.do?indexTerm=X&tabID=&bobIndexId=&actionString=doBrowseIndex&searchId=&currentPosition=&docId=GALE%7CCX4154399901&userGroupName=hennepin&inPS=true&contentSegment=9780806364902&source=&prodId=GENVRL&isDownloadOptionDisabled=true%20&selectedIndex=INDEX%20OF%20NAMES>

Name: Ann Maria Xelander

Age: 28

Birth Year: abt 1746

Arrival Year: 1774

Arrival Place: Philadelphia, Pennsylvania

Primary Immigrant: Xelander, Christopher

Family Members: Wife Ann Maria 28

Source Publication  
Code: 9151

Annotation: Contains 35 articles excerpted from The New England Historical and Genealogical Register, 1847-1961. About 17,000 names. Similar lists in Boyer, nos. 0702, 0714, 0717, 0720.

Source: TEPPER, MICHAEL, editor. Passengers to America: A Consolidation of Ship Passenger Lists from "The New England Historical and Genealogical Register." Baltimore: Genealogical Publishing Co., Bibliography: 1977. 554p. Reprinted with new introduction and indexes, 1978. Repr. 1980.

## 1.2 Census & Tax Records

### 1.2.1 1788 tax list for West Pennsboro

See image 215 of [https://www.ancestry.com/imageviewer/collections/2497/images/33020\\_254649-00709?pid=1337570](https://www.ancestry.com/imageviewer/collections/2497/images/33020_254649-00709?pid=1337570) .

no of acres	Name	Taxes	Total
124	Shock Jacob	124	124
250	Sample Robert	500	500
	Selander Christian Shoemaker & Co	100	100

# Children of Johann Christian & Anna Maria Selanders

## 1.2.2 1793 & 1800 Septennial Census for PA

See [https://www.ancestry.com/search/collections/2702/?name=s\\_selander&count=50&name\\_x=s\\_ps&residence=cumberland-pennsylvania-usa\\_789](https://www.ancestry.com/search/collections/2702/?name=s_selander&count=50&name_x=s_ps&residence=cumberland-pennsylvania-usa_789)

The record shows the elder Christian as well as his son by the same name.

View Record	Name	Residence Year	Residence Place	View I
<a href="#">View Record</a>	Christian Selander	1793	Dickinson, Cumberland, Pennsylvania	<a href="#">View I</a>
<a href="#">View Record</a>	Christ Selander	1800	Middleton, Cumberland, Pennsylvania	<a href="#">View I</a>
<a href="#">View Record</a>	Christ Selander Junior	1800	Middleton, Cumberland, Pennsylvania	<a href="#">View I</a>

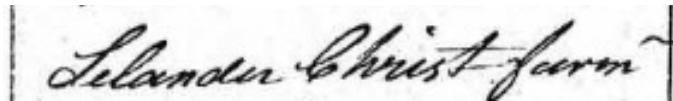
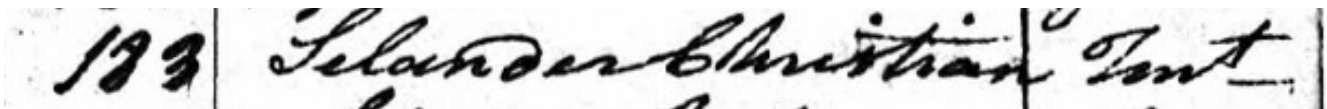

## 1.2.3 1798 Tax List

Christian's presence in Cumberland Co., PA, is shown in a 1798 tax list. See image 347 of <https://www.ancestry.com/discoveryui-content/view/328499:2060>. He was living in a two-story wood building (33x33 ft), with four windows! Rented? From Robert Miller.

A.

**P**ARTICULAR List or Description of each Dwelling-house, which, with the Outhouses appurtenant thereto, and the Lot on which the same are erected, not exceeding two Acres in any Case, were owned, possessed, or occupied, on the First Day of October, 1798, in the State of Pennsylvania, and exceeding in Value the Sum of One Hundred Dollars.

1 Name of Occupant or Possessor.	2 Name of Owner.	3					4			5			6					
		Dwelling House.	Outhouses Appurtenant.	Dimensions or Area.	Materials of which built.	Number of Windows.	Number of Houses, &c. claimed to be exempted from Valuation.	Quantity of Land in the Lot.	Dwelling House.	Quantity of Land in the Lot.	Value of each Dwelling-house with the Outhouses appurtenant thereto, by the First Day of the Month of October, 1798.	Value of each Dwelling-house with the Outhouses appurtenant thereto, by the First Day of the Month of October, 1798.	Dollars	Cents				
George Miller	Miller Robert	1		31 by 20	Stone	2	7	66				2			460		130	
Christ Selander	Miller Robert	1		33 by 33	Wood	2	4	66				2			350		350	
Mouland James	Mouland James	1		18 by 18	Wood	1	1	4				2			100	10	100	10
												2			300		300	

# Children of Johann Christian & Anna Maria Selanders

## 1.3 Death(s)

The will for Christian (elder): index "Pennsylvania Probate Records, 1683-1994," images, FamilySearch (<https://familysearch.org/ark:/61903/3:1:3QSQ-G99B-JGBH?cc=1999196&wc=9PMZ-RMQ%3A268498501%2C270712001> : 3 July 2014), Cumberland > Will index 1750-1937 K-S > image 400 of 496; county courthouses, Pennsylvania.

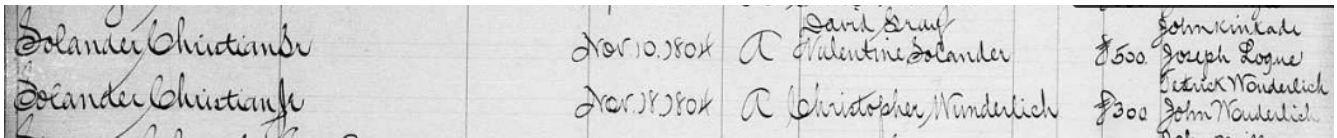

This record shows that the elder Christian died 12/8/1804 and that the executor for his estate was his son, Valentine. (Son Christian died 2/26/1805, just over a year later, and the executor was Christopher Wunderlich, who I believe was his brother in-law.) He is also present in records of the First Evangelical Lutheran Church in Carlisle, PA.

I have not found a believable death record for Christian's wife, but one person on ancestry.com states that it is 1/11/1795 in PA. This, however, must be weighed against the following record from the 1800 census. This record from the 1800 census likely shows the Christian Selander family in Middleton, Cumberland County, PA. <https://www.familysearch.org/ark:/61903/3:1:33S7-9R8K-9G6P?i=7&cc=1804228&personUrl=%2Fark%3A%2F61903%2F1%3A1%3AXHRD-P4N>

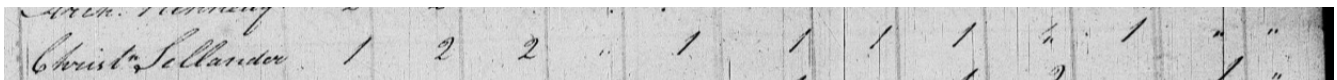

It indicates one male over 45 and one female over 45, so Anna Maria may in fact have been alive at this time. It also shows one female under 10 years. Perhaps this was Catherine. Two other children in the list remain unaccounted for (a girl and a boy both between 10 and 15).

# Children of Johann Christian & Anna Maria Selanders

## 1.4 Lists of Children

From familysearch.org: <https://www.familysearch.org/tree/pedigree/landscape/LLM1-D4V>

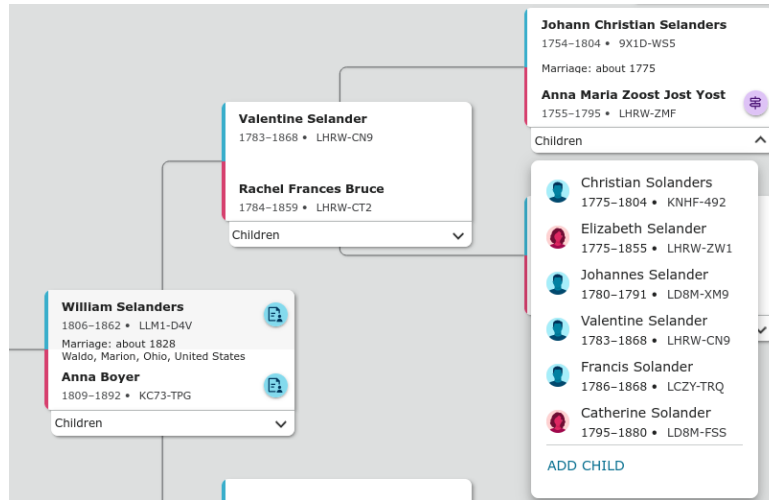

One ancestry entry for the family shows 6 children, but the list is not quite the same.

(<https://www.ancestry.com/family-tree/person/tree/9623519/person/332345515677/facts> )

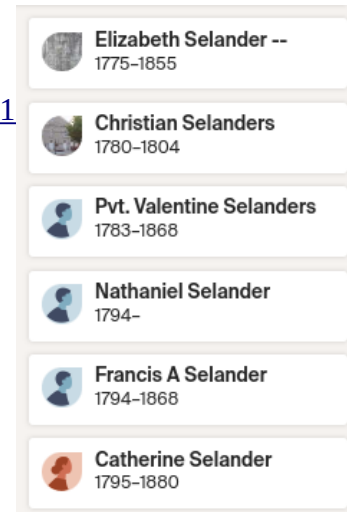

I have so far found no unequivocal evidence other than the surname to link Catherine Solander to the family of Christian and Anna Maria. If she is indeed their daughter, she was born rather late in their lives, but not unreasonably so. BTW, I have not found evidence for another Selander/Xylander/Solander family in the area.

I also have found no information about Nathaniel. Jonathan's existence is clearly established, however. Sections that follow show what I have found regarding the children (**Elizabeth, Christian, Jonathan, Valentine, Francis, and Catherine**).

# Children of Johann Christian & Anna Maria Selanders

As a hint, here is an overview of where I believe the six children eventually moved/stayed.

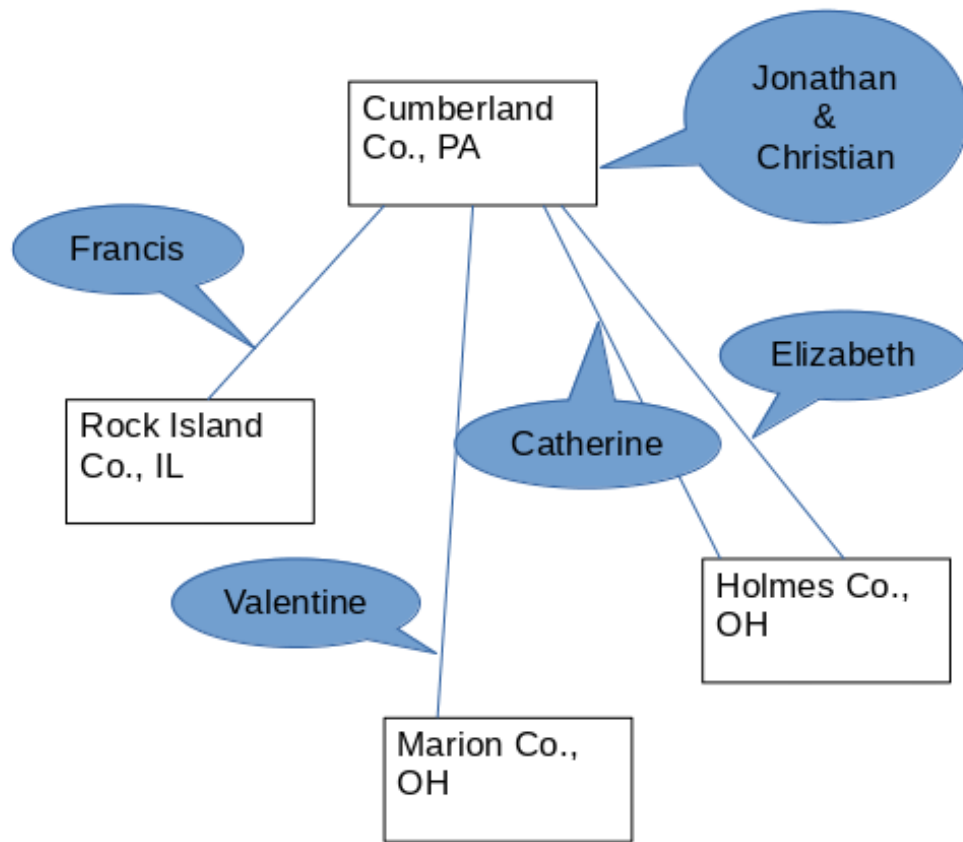

# Children of Johann Christian & Anna Maria Selanders

## 2 Elisabeth (1775-1855)

### 2.1 Birth

Date inferred indirectly from other sources. She is likely the first child of Christian & Anna Maria.

### 2.2 Marriage

Elizabeth married David Gray (in 1799? in Cumberland Co., PA), and they moved to Holmes Co., Ohio. The headstone there indicates the birth date of 1775. See <https://www.findagrave.com/memorial/31074413/elizabeth-gray>.

### 2.3 Children

Children of Elizabeth and David are commonly listed as follows. A cursory glance at descendants makes me think that most stayed in the Holmes County, OH, area.

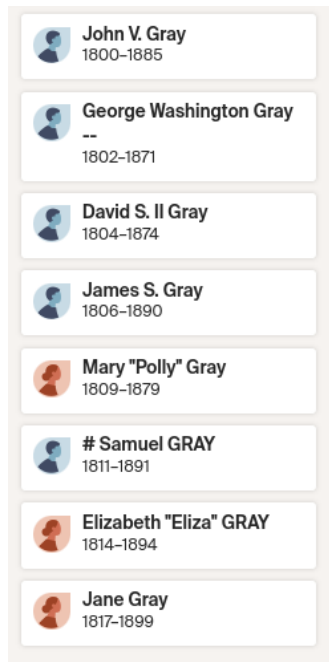

# Children of Johann Christian & Anna Maria Selanders

## 2.4 1850 Census (Holmes Co., OH)

It appears that David died shortly before 1850 (3/20/1849? in Millersburg, Holmes Co., OH). The remaining family is listed as follows in the 1850 census for Holmes Co., OH. See "United States Census, 1850", database with images, *FamilySearch* (ark:/61903/1:1:MXQD-KQ3 : Wed Dec 28 16:01:17 UTC 2022), Entry for Elizabeth Gray and Harriet Gray, 1850.

<https://www.familysearch.org/ark:/61903/1:1:MXQD-KQ9>

SCHEDULE I.—Free Inhabitants in *Dist. No. 75 Mechanics Township* in the County of *Holmes* State of *Ohio* enumerated by me, on the *19th* day of *Aug* 1850. *W. M. Adams* Ass't Marshal.

Dwelling-house numbered in the order of visitation.	Family numbered in order of visitation.	The Name of every Person whose usual place of abode on the first day of June, 1850, was in this family.	DESCRIPTION.			Profession, Occupation, or Trade of each Male Person over 15 years of age.	Value of Real Estate owned.	PLACE OF BIRTH. Naming the State, Territory, or Country.	Whether deaf and dumb, blind, insane, idiotic, pauper, or convict.			
			Age.	Sex.	Color (black or mulatto).				Married within the year.	Attended school within the year.	Present over 1 year ago who cannot read & write.	
1	2	3	4	5	6	7	8	9	10	11	12	13
		<i>Samuel Carucham</i>	<i>3</i>	<i>M</i>				<i>Ohio</i>				
		<i>Mary</i>	<i>20</i>	<i>F</i>				<i>do</i>				
		<i>C. E.</i>	<i>60</i>	<i>F</i>				<i>do</i>				
<i>1061</i>	<i>1062</i>	<i>John Feick</i>	<i>28</i>	<i>M</i>		<i>Farmer</i>	<i>500</i>	<i>do</i>			<i>1</i>	
		<i>Anne</i>	<i>60</i>	<i>F</i>				<i>do</i>				
		<i>Peter</i>	<i>72</i>	<i>M</i>				<i>do</i>				
		<i>Anne Nidell</i>	<i>15</i>	<i>F</i>				<i>do</i>			<i>1</i>	
<i>1062</i>	<i>1063</i>	<i>Elizabeth Gray</i>	<i>70</i>	<i>F</i>			<i>300</i>	<i>Penn</i>				
		<i>Ann</i>	<i>33</i>	<i>F</i>				<i>do</i>				
		<i>Elizabeth</i>	<i>10</i>	<i>F</i>				<i>Ohio</i>			<i>1</i>	
		<i>Olive</i>	<i>15</i>	<i>F</i>				<i>do</i>			<i>1</i>	
		<i>Jackson</i>	<i>9</i>	<i>M</i>				<i>do</i>				
		<i>Margann</i>	<i>6</i>	<i>F</i>				<i>do</i>				
		<i>Harriet</i>	<i>3</i>	<i>F</i>				<i>do</i>				

Holmes is the same county in which we find information about Catherine (b.1795), who is a possibly sister to Elizabeth. Perhaps two families moved together to Holmes Co.



# Children of Johann Christian & Anna Maria Selanders

## 2.5 1840 Census (Holmes Co., OH)

The 1840 census for Mechanic Twp., Holmes Co. shows many Gray families. See <https://www.familysearch.org/ark:/61903/3:1:33S7-9YT5-9X3B?i=6&cc=1786457&personUrl=%2Fark%3A%2F61903%2F1%3A1%3AXHYV-VQM>

A handwritten census record from 1840 for Mechanic Twp., Holmes Co., OH. The record lists several Gray families with their respective counts in various columns. The names are written in cursive, and the counts are numbers or slashes. The columns represent different age groups or categories as per the 1840 census format.

Name	1	2	3	4	5	6	7	8	9	10	11	12	13	14	15	16	17	18	19	20
John Gray								/												/
John Gray	1	2	1	1				/												/
James Gray	1							/												/
Robert Gray								/												/
James Gray	2							/												/
David Gray								/												/
Paul Gray	2	1						/												/
Paul Gray	1	2	2					/												/

Perhaps these are related since they are geographically close to each other.

# Children of Johann Christian & Anna Maria Selanders

## 3 Christian (1775/1780?-1804)

The existence and relation of Christian (the younger) is reasonable well documented. It is reasonable to assume that he, his wife, and family lived near Carlisle in Cumberland Co., PA.

### 3.1 Birth (1780?)

No sources found. I am not sure where the estimate came from that is found on familysearch. The AGBI shows a range of 1780-9, but I think the lowest number is the most believable based on the marriage date.

### 3.2 Marriage (1801) and Children

10/27/1801 in Carlisle, PA - from 1785 - 1812 *Marriage Records First Presbyterian Church Borough of Carlisle Cumberland County, Pennsylvania.*

<http://www.newhorizonsgenealogicalservices.com/pennsylvania-genealogy/cumberland-county/first-presbyterian-church-carlisle-pa-marriage-records-1785-1812.htm>

1801, Oct. 27, Selander, Christian, and Eliz. Wunderlich.

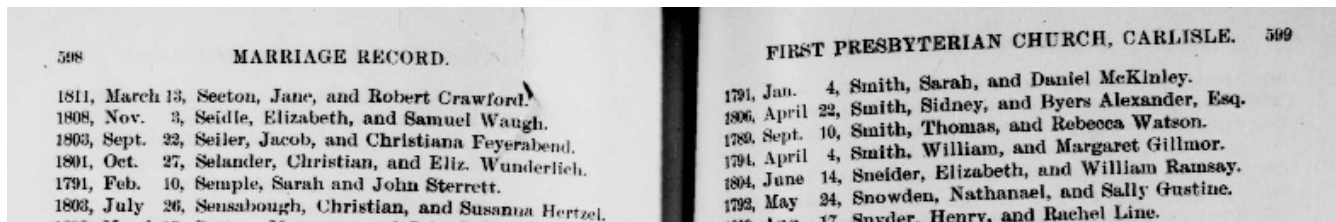

[Note: Henry Snyder and Rachel Line were also married here 8/17/1809.]

Also . . .

Selander, Christian  
Married 27 Oct 1801 by Rev Robert Davidson, Christian Selander to Elizabeth Wunderlich

# Children of Johann Christian & Anna Maria Selanders

Information about Christian's children can be had from *Genealogical Record of the Wunderlich Family in America: Seventeen Branches*, by Charles Albert Cornman. See Google books . . .

<https://books.google.com/books?id=wclfAAAAMAAJ&pg=PA140#v=onepage&q&f=false> , page 140.

## B. 11. EVA ELIZABETH WUNDERLICH.

(Solander and Wise Branch)

- B. 11. Eva Elizabeth Wunderlich, b. Sept. 29, 1781; d. May 1, 1843; m. (1st) April 7, 1801, Christian Solanders, b. 1780; d. 1804.
- C. 1. John Solanders, b. March 7, 1802; d. Nov. 10, 1878; m. Jan. 4, 1846; Catherine Zeigler, b. Nov. 20, 1820.
- D. 1. Mary E. Solanders, b. Dec. 28, 1847; m. Henry Rice, b. Feb. 24, 1840.
- E. 1. Frank S. Rice, b. December 28, 1866.
- E. 2. Harry Rice, b. September 15, 1868.
- E. 3. Bert S. Rice, b. July 30, 1871.
- C. 2. Daniel Solanders, b. Feb. 21, 1804; m. Dec. 22, 1826, Mary First, b. Dec. 25, 1805.
- D. 1. John Solanders, b. Nov. 3, 1831; m. Oct. 7, 1855, Esther Borker, b. Aug. 16, 1835.
- E. 1. Edward N. Solanders, b. December 13, 1857.
- E. 2. ————— Solanders, b. February 27, 1861.
- D. 2. Henry J. Solanders, b. July 22, 1836; m. April 7, 1854, Mary McAllister, b. June 30, 1834.
- E. 1. Edward B. Solanders, b. July 25, 1856.
- E. 2. Effie S. Solanders, b. January 9, 1865.
- E. 3. John Solanders, b. November 26, 1870.
- E. 4. Orië D. Solanders, b. May 23, 1878.
- D. 3. Elizabeth C. Solanders, b. May 28, 1839; m. March 17, 1859, Calvin Lee, b. March 5, 1837.
- E. 1. Riley Lee, b. April 9, 1860.
- E. 2. Asa Lee, b. March 20, 1862.
- E. 3. Mary Lee, b. March 15, 1864.
- E. 4. Clara E. Lee, b. April 6, 1866.
- D. 4. David F. Solanders, b. July 19, 1841 m.; Nov. 25, 1866, Sallie Skiles.
- E. 1. Jennie Solanders, b. December 25, 1869.

140

*Eva Elizabeth Wunderlich—Solander and Wise Branch.* 141

- E. 2. Guy Solanders, b. April 11, 1872.
- E. 3. ————— Solanders b. July 16, 1877.
- D. 5. Clarissa E. Solanders, b. Oct. 19, 1843; m. April 29, 1867, Samuel Bonebrake, b. Feb. 27, 1838.
- E. 1. Lillian C. Bonebrake, b. January 24, 1869.
- E. 2. Claude W. Bonebrake, b. September 1, 1872.
- E. 3. Letitia Bonebrake, b. October 19, 1874.
- E. 4. Louis W. Bonebrake, b. December 28, 1876.

## Children of Johann Christian & Anna Maria Selanders

### 3.3 Other PA Evidence (1800-1826)

From the PA Septennial Census 1800:

<https://www.ancestry.com/search/collections/2702/?>

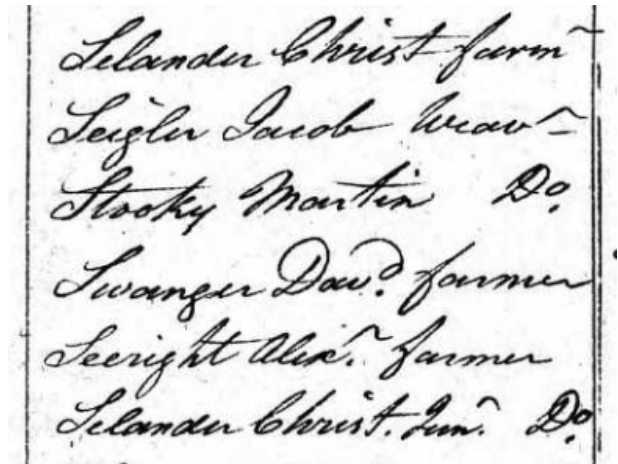

Selander Christ farm  
Seigler Jacob weaver  
Stokey Martin Do.  
Swanger Dav? farmer  
Seeright Alex? farmer  
Selander Christ. Jun? Do.

[name= selander&count=50&name\\_x=s\\_ps&residence= cumberland-pennsylvania-usa\\_789](#) Showing both father & son.

Someone named John "Sollander" was married in the First Lutheran Church in Carlisle in 1821. This is probably Christian's son.

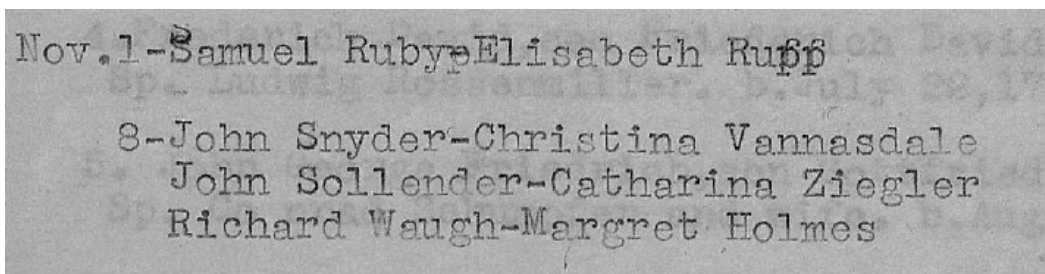

Nov. 1 - Samuel Ruby - Elisabeth Rupp  
8 - John Snyder - Christina Vannasdale  
John Sollender - Catharina Ziegler  
Richard Waugh - Margret Holmes

Son Daniel was married in Carlisle, PA, to Mary First on 12/21/1826. See

<https://www.ancestry.com/search/collections/2451/>

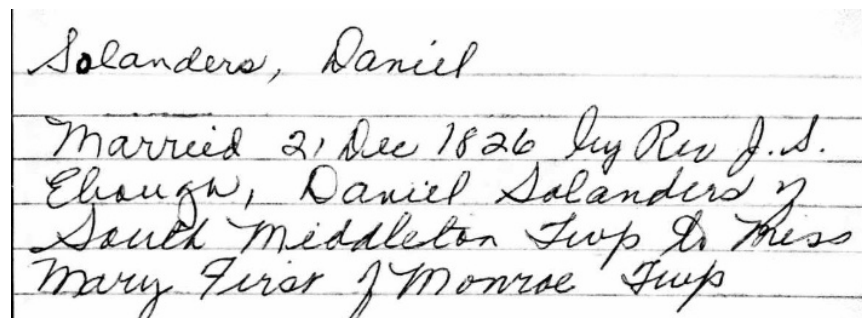

Selanders, Daniel  
Married 21 Dec 1826 by Rev J.S.  
Ehough, Daniel Selanders of  
South Middleton Twp to Miss  
Mary First of Monroe Twp

# Children of Johann Christian & Anna Maria Selanders

## 3.4 Death (~11/1804)

Here is a timeline that may be useful. Start with footnote 6 in

<https://websites.umich.edu/~bobwolfe/gen/mn/m10934x10935.htm#Fm10934x10935N3> .

### Notes for Frederick Wise and Eva Elizabeth Wunderlich

1798 John and Frederick Wise, sons of Jacob Wise and grandsons of Jacob Wise, were named in the will of their grandfather, who died in Cumberland County, Pennsylvania. [1]

1799 Frederick Weise was taxed in South Middleton Twp, Cumberland County, Pennsylvania as a freeman (single, no land). [2] This suggests he was at least age 21 and was born before 1778.

1800 Frederick Wise, farmer, was listed on the septennial census for Middleton Twp, Cumberland County, Pennsylvania. [3]

1801 Eva Elizabeth Wunderlich married Christian Solanders on April 7. Christian Solanders died not long after, in 1804. [4]

1802 Mrs Catherine Wise, wife of Frederick Wise, died in child-birth at age 19 years and 8 weeks. She was buried at the dwelling of her father, Peter Puttaw. [5] Perhaps this is the same Frederick Wise who later married Eva Wunderlich Solander.

1804 Letters of administration were issued to Valentine Solander and David Gray for the estate of Christian Solander, deceased. [6]

1806 Christopher Wunderlich petitioned the Cumberland County Orphans' Court, on May 13, to cite Valentine Salender and David Gray, administrators of the estate of Christian Salendar, deceased, to appear. [7] Widow Elizabeth Salender petitioned the court to appoint guardians for John and Daniel Salender, orphans, under the age of 14, of Christian Salender, deceased. Elizabeth was appointed as guardian. [8] On 9 September, Valentine Selander and David Gray presented the account of the estate of Christian Selander to the Orphans Court, showing a balance of £211. [9]

1806 Mrs Elizabeth Salander [previously Eva Elizabeth Wunderlich] married John Frederick Wise, both of Middleton Twp, Cumberland County, on September 1. [10] [11] [12] [13]

# Children of Johann Christian & Anna Maria Selanders

Will: "Pennsylvania Probate Records, 1683-1994," images, FamilySearch

(<https://familysearch.org/ark:/61903/3:1:3QSQ-L9SM-7996-G?cc=1999196&wc=9PMK-K66%3A268498501%2C268498502> : 3 July 2014), Cumberland > Administration records 1750-1845 vol A-D > image 221 of 664; county courthouses, Pennsylvania.

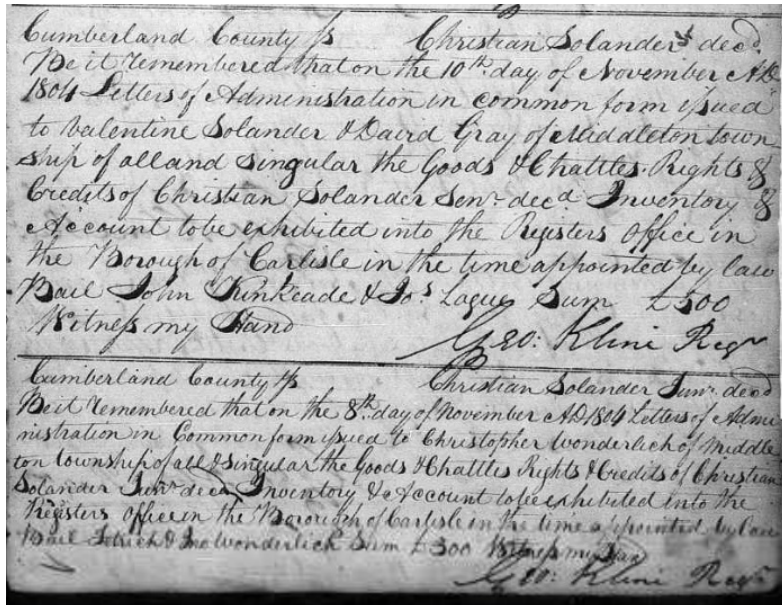

And <https://www.familysearch.org/ark:/61903/3:1:3QSQ-899B-J317?i=78&cc=1999196&cat=421696>

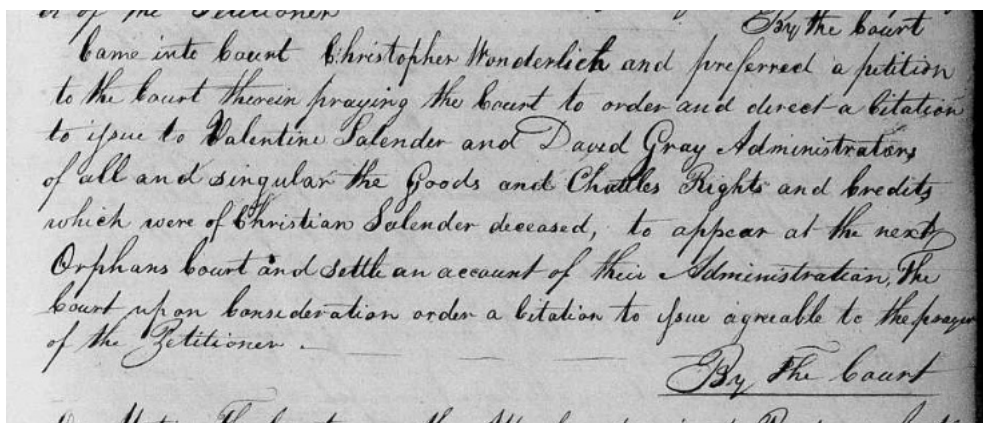

Will index: "Pennsylvania Probate Records, 1683-1994," images, FamilySearch

(<https://familysearch.org/ark:/61903/3:1:3QSQ-G99B-JGBH?cc=1999196&wc=9PMZ-RMQ%3A268498501%2C270712001> : 3 July 2014), Cumberland > Will index 1750-1937 K-S > image 400 of 496; county courthouses, Pennsylvania.

Selander Christian Sr	Nov 10, 1804	A	David Gray Valentine Selander	\$500	John Kinkeade Joseph Logue
Selander Christian Jr	Nov 11, 1804	A	Christopher Wunderlich	\$300	Estrick Wunderlich John Wunderlich

# Children of Johann Christian & Anna Maria Selanders

## 4 Johannes (1780-1791)

Johannes did not survive long as indicated in the record that follows.

Death of Johannes in 1791: (Source Information Lineages, Inc., comp.. *Cumberland County, Pennsylvania Church Records* [database on-line]. Provo, UT, USA: Ancestry.com Operations Inc, 2000. )

**Surname:** Johannes Selander  
**Description:** Deceased  
**Event:** Burial  
**Date:** 17 Sep 1791  
**Place:** Cumberland Co., PA  
**Church:** Records of First Evangelical Lutheran Church, Carlisle, Cumberland County, Pennsylvania, 1788-1923  
**Remarks:** From Middletown Township, died at age 11-3/4 years.

Also . . .

Surname Christian Selander

Description Father

Event Burial

ChurchRecords of First Evangelical Lutheran Church, Carlisle, Cumberland County, Pennsylvania, 1788-1923

Remarks From Middletown Township, died at age 11-3/4 years.

# Children of Johann Christian & Anna Maria Selanders

## 5 Valentine (1783?-1868)

It appears to me that Valentine, his wife (Rachel), and their four children relocated from Cumberland Co., PA, to Marion Co., OH, sometime between 1833 and 1836. This is based on the birth dates and birth locations for his son William's children as shown the the 1850 census for Waldo Co. See "United States Census, 1850," database with images, *FamilySearch* (<https://www.familysearch.org/ark:/61903/1:1:MXQL-MVD> : 21 December 2020), William Selanders, Waldo, Marion, Ohio, United States; citing family , NARA microfilm publication (Washington, D.C.: National Archives and Records Administration, n.d.).

Valentine and Rachel have their own household until about 1859, when Rachel dies. Shortly thereafter Valentine moves in with daughter Malinda and her husband Sylvester Boyd. Valentine dies in the late 1860s.

I believe that understanding Valentine and his children is central to understanding the Snyders and Culps that lived near each other as shown in the 1850 census. Some supporting information follows.

### 5.1 Birth (1783?)

No sources found. Year inferred indirectly.

### 5.2 Marriage (1804-1805?) to Rachel and Subsequent Children

No sources found. Year inferred indirectly. Various places indicate that Valentine's wife was named Rachel Frances Bruce (b. 7/28/1784 in PA), daughter of William A. Bruce and Mary Perciful Lucas, both of Virginia.



# Children of Johann Christian & Anna Maria Selanders

## 5.2.1 William (1806?-1862)

William was born in Cumberland Co., PA, some time between 1805-1807 based on census records. He married Anna Boyer in PA around the year 1830 or somewhat earlier.

Information about Anna follows. See <https://www.familysearch.org/tree/person/details/LLM1-D4V> , <https://www.findagrave.com/memorial/53335344/william-selanders> , <https://www.findagrave.com/memorial/53335412/anna-selanders> . Anna's obituary (from findagrave) follows. Cumberland Co., PA, is mentioned. She and her future husband seem to have come to OH with one child between 1833 and 1836 according to the birth years of children mentioned in the 1850 census. This almost exactly parallels John and Catherine Snyder. This and the fact that they lived near each other makes me wonder if they traveled together and perhaps started out together from PA.

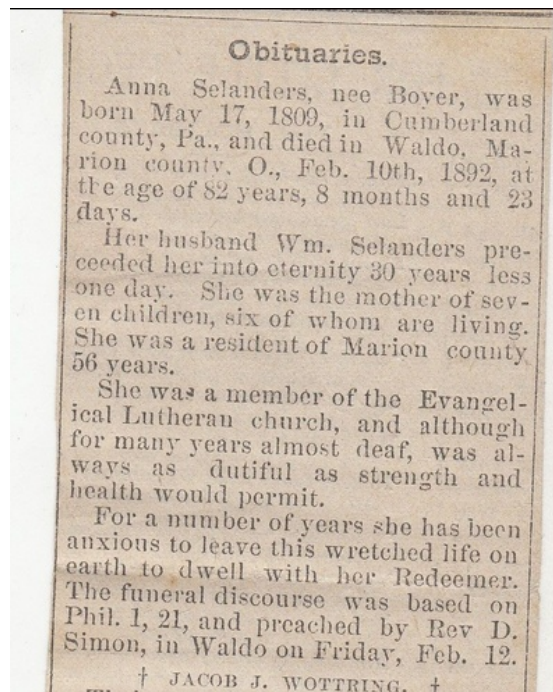

Probably in 1833 (est.) William and his family moved with his father, Valentine, and some siblings and their families to Marion Co., OH. Anna and William had the following children that are listed in William's will: Melinda, Alvina, Samuel, Valentine, Mary, Frances Elizabeth, and Sarah. William died in 1862 in Waldo. His probate record exists, lists his surviving children, and indicates that Valentine Coleman (daughter Mary's husband) is his executor.

- **Alvina** (b~1829 in PA) married Jacob Coleman in 1849 in Waldo Twp, and she was buried there in 1914. In 1860, they were living close to her father, William.

## Children of Johann Christian & Anna Maria Selanders

- **Samuel** (b.~1831 in PA) married Mariah Miller in 1855 and died probably in Mercer Co., OH, in 1919.
- In 1855 **Melinda** (b.~1833 in PA) married Frederick Ellmaker (Co. C, 145th Ohio Inf.), and she died in 1895 in Waldo Twp.
- **Mary** (b.~1836 in OH) married Valentine Coleman in Delaware Co., OH, in 1854. Mary and Valentine's marriage is recorded here <https://www.familysearch.org/ark:/61903/1:1:X8FM-S7Q>.

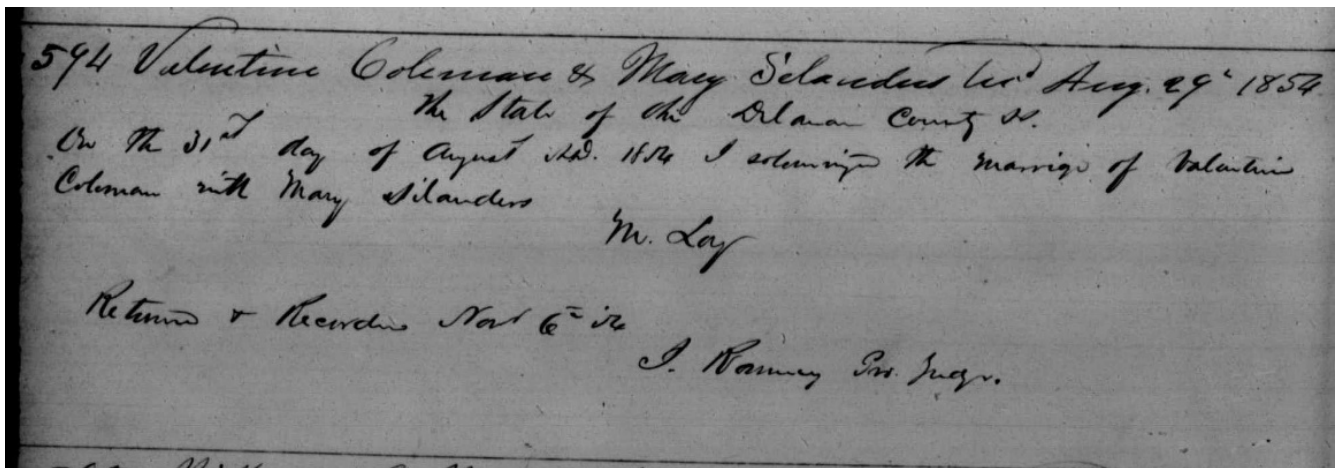

Valentine Coleman served as executor for William Selanders' estate. Valentine is somewhat older than Mary (by 6 years). He and Mary and their children are likely listed in the 1850 census next to his possible father (John) as follows. See "United States Census, 1850," database with images, FamilySearch (<https://www.familysearch.org/ark:/61903/1:1:MXQL-HSM> : 21 December 2020), Valentine Coleman, Waldo, Marion, Ohio, United States; citing family , NARA microfilm publication (Washington, D.C.: National Archives and Records Administration, n.d.).

21	21	Valentine Coleman	34	M	Farmer	900	Pa	
		Mary	28	F			0	
		William	6	M			0	
		Eliabeth	5	F			0	
		Catharine	1	F			0	
25	25	John Coleman	63	M	Farmer	3500	Pa	
		Barbra	35	F			0	Summary
		Barbra	17	F			0	1
		Susan	15	F			0	1
		Frederick	12	M			0	1



## Children of Johann Christian & Anna Maria Selanders

- **Valentine** (b.~1840 in OH): Valentine served in the Civil War (Ohio, 4th Battalion, Company C). He married Amy Emma/Ellen Ayers in about 1870. They lived in Waldo Twp, where they raised their children. His death is given as 1922 in Waldo. See <https://www.findagrave.com/memorial/184175454/valentine-e-selanders> .
- **Frances Elizabeth** (b.~1843 in OH) Frances never married. In 1880, she was living with her mother, Anna, in Waldo Twp next to Valentine and Amy (Ayers) Selanders. (<https://familysearch.org/ark:/61903/1:1:M89T-WD5> ) She died 10/1/1890 in Waldo. (<https://www.findagrave.com/memorial/91842827/frances-e-selanders> )
- **Sarah** (b.~1848 in OH) Sarah (Ann) probably married Henry Strine 5/5/1870 in Waldo. They appear to have had four children. However, there is confusion in the records between a Sarah born to William and one born to Samuel Selanders (b.1831), William's son. This Sarah died in Waldo in 1912. By the way, Samuel was present in William's house in 1850 and did not marry until 1855. Sarah is also mentioned in William's will in 1862. The 1860 census shows that Samuel did indeed have a daughter named Sarah in about 1860, so there are two Sarahs, but they are 12 years apart in age. Meanwhile, based on the 1870 census and the age of Sarah Strine, I favor the view that William's daughter Sarah married Henry Strine. See <https://familysearch.org/ark:/61903/1:1:M6LQ-L7H> . Here they are in 1880 <https://familysearch.org/ark:/61903/1:1:M89T-WC4> . Someone will have fun sorting all this out.

### 5.2.2 Samuel Adam (1817-1871?)

Born about 1817 in PA, Samuel married Sarah Koph in 8/1/1839 in OH and probably died in 1871 in Waldo. This summary (<https://www.familysearch.org/tree/person/details/L44D-HQ4> ) indicates that they had 10 children.

### 5.2.3 Ellen (Eleanor) (1806-9? - 1903)

Ellen's birth date is estimated from census records, which are not very consistent. 1808 might be a best guess for now. She married Simon Culp on March 20, 1828 in Silver Spring Presbyterian Church.

1828 Jan 17. Peter Bricker to Catharine Butdorff	Geo. Butdorff & Monmouth
March 6. John Wolf to Sarah Orr	John Orr & James Given
— 20 Simon Culp to Ellen Selander	Valentine Selander & John Bender
Nov. 4 John Boston to Catharine Umbarger	Absalom Martin & Umbarger
Dec. 2. D. A. J. Dean to Adeline Junkin	Dr. Joseph brain & Ellen brain

## Children of Johann Christian & Anna Maria Selanders

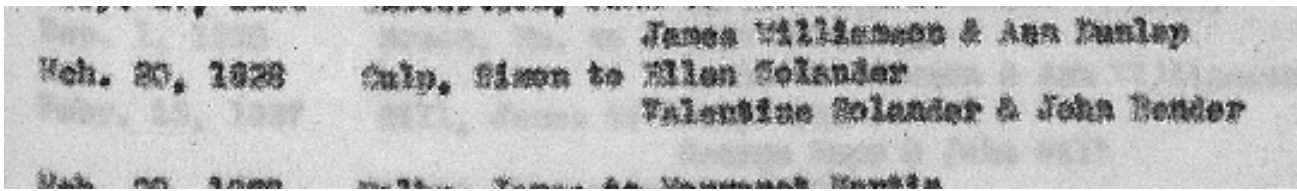

See <https://www.ancestry.com/search/collections/2451> image 72 (Pennsylvania and New Jersey, U.S., Church and Town Record, 1669-2013).

The 1850 census (<https://familysearch.org/ark:/61903/1:1:MXQL-MKC>) shows them in Waldo Twp.

Simon Culp	49	M	Farmer	500	Pa		
Ellen	19	F			Pa		
Rachel	21	F			Pa		
Caroline	18	F			Pa		
Valentine	15	M			Pa		1
Melinda	12	F			O		1
Margaret	9	F			O		1
Mary	4	F			O		
Annus Murch	22	M	Carpenter		Pa		

Children are **Rachel** b.1829 in PA, **Caroline** b.1832 in PA, **Valentine** b.1835 in PA, **Melinda** b. 1838 in OH, **Margaret** b. 1841 in OH, **Mary** b. 1846 in OH. This indicates that this Culp family might have migrated from PA in about 1837 (later than the William Selanders and John Snyder families).

The 1860 census shows them in Delaware County, OH. See "United States Census, 1860", database with images, FamilySearch (<https://familysearch.org/ark:/61903/1:1:MCL2-XMT> : 18 February 2021), Simon Culp, 1860. They are living next to William Glaze.

952	960	Simon Culp	62	M	Farmer	600	"		
		Ellen	54	F			"		
		Margaret	19	F			O		
		Mary	13	F			"		1
955	967	Wm Glaze	30	M	Carpenter	300	100	"	
		Elizabeth	21	F				"	
		John	3	M				"	
		George	1	M				"	
		Isabella Rhodes	9	F				"	



# Children of Johann Christian & Anna Maria Selanders

## 5.2.4 Malinda (1818-1901)

Malinda was born on 11/10/1818 according to

<https://www.familysearch.org/tree/person/details/LHRW-C6Z> . She married Sylvester Boyd in Marion Co., OH, on 2/11/1840. See <https://familysearch.org/ark:/61903/1:1:XZ6Y-8QL> . They seem to have had four children: Austin A., William E., Joseph V. and Lena. She died 11/26/1901 in Prospect Twp, Marion Co., OH. See this census entry, which also show her father Valentine - <https://familysearch.org/ark:/61903/1:1:MCGN-V2N> and this source for death info <https://www.findagrave.com/memorial/51925278/malinda-boyd> .

Some details regarding Sylvester's family are here

[http://www.markboyd.info/fam\\_history/BoydFamily/Joseph\\_Boyd\\_Sr.-Six\\_Generations.pdf](http://www.markboyd.info/fam_history/BoydFamily/Joseph_Boyd_Sr.-Six_Generations.pdf) . A section from this document follows.

*A biography of Joseph's family is included in a sketch of his son, John Wesley Boyd, published in a county history.<sup>15</sup>*

*John Wesley Boyd ... is a son of Joseph and Sarah (Devol) Boyd, both born near the Potomac River in Maryland, who came to Ohio about the year 1814, and located in Licking County, and in 1825 or 1826 came to Marion County and entered eighty acres of land three miles north of Waldo. They subsequently bought 160 acres of land in Pleasant Township, some three or four miles west of their first farm. The father died on the old farm in 1850, and his wife died at the same place four years afterward. They had four children - Edwin, Sylvester, John W. and George. Previous to his marriage to Sarah Devol, he was married to Miss Scott, by whom he had the following children: Joseph, Hiram, William, Eleanor, Ann and Mary, all deceased. He was an old-line Whig in politics, and served the township as Justice of the Peace two terms.*

One of the sons of Malinda and Sylvester is remembered in the following note. See

[http://www.ohiogenealogyexpress.com/marion/marionco\\_bios\\_1883/marionco\\_bios\\_1883\\_b.htm](http://www.ohiogenealogyexpress.com/marion/marionco_bios_1883/marionco_bios_1883_b.htm) . The birth date for Austin is wrong. It should probably be 1841.

*Prospect Twp. -*

*AUSTIN A. BOYD, farmer, was born in Waldo Township, this county, Jan. 6, 1811, and was the son of Sylvester and Melinda S. (Selanders) Boyd. Mr. Boyd has always been engaged in farming, and is now farming forty acres of the old homestead in Prospect Township, which was bought by his father in 1862. His father died on his farm Jan. 31, 1871, and the widow still resides there. Our subject was married Nov. 2, 1871, to Mary E. Wasser, daughter of Charles Wasser, of Prospect Township. They have three children - Edna May, born Dec. 1, 1874; Charles Carey, Nov. 23, 1876; and Mary E., Aug. 18, 1878. Mr. Boyd is a member of Prospect Lodge, No. 483, I. O. O. F., and in politics, is a Republican.*

# Children of Johann Christian & Anna Maria Selanders

Source: *The History of Marion Co., Ohio - Published Chicago: Leggett, Conaway & Co. - 1883 - Page 913*

## 5.3 1810 Census (E. Pennsboro Twp, Cumberland Co., PA)

1810 Census in E. Pennsboro Twp. -

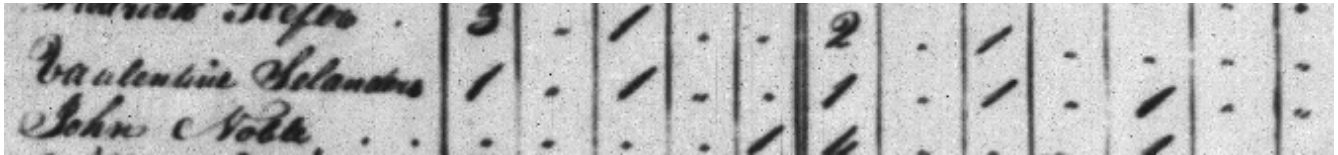

## 5.4 1820 Census (E. Pennsboro Twp, Cumberland Co., PA)



1820 U S Census; Census Place: East Pennsboro, Cumberland, Pennsylvania; Page: 66; NARA Roll: M33\_102; Image: 28 (image 6)

## 5.5 1830 Census (Silver Spring Twp, Cumberland Co., PA)

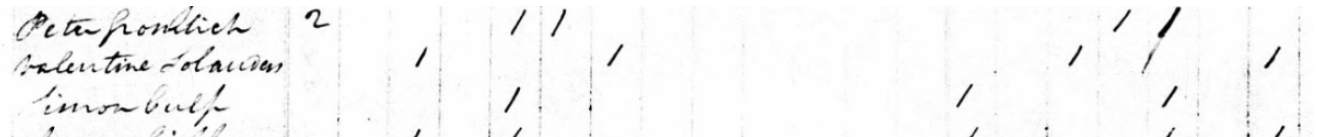

Year: 1830; Census Place: Silver Spring, Cumberland, Pennsylvania; Series: M19; Roll: 150; Page: 99; Family History Library Film: 0020624 (image 15) (<https://familysearch.org/ark:/61903/1:1:XHPR-J7Y>)

Notice that the Selanders family is right next to that of Simon Culp!

## 5.6 1850 Census (Marion Co., OH)

Residence in 1850 (Pleasant Twp, Marion Co., OH) : <https://familysearch.org/ark:/61903/1:1:MXQL-NMT> . See the more detailed analysis in a subsequent section- see page 39.



# Children of Johann Christian & Anna Maria Selanders

## 5.7 1860 Census (Marion Co., OH)

Residence in 1860: with daughter Malinda (Boyd) (Waldo Twp, Marion Co., OH) :

<https://familysearch.org/ark:/61903/1:1:MCGN-V2L> (Transcription corrected at familysearch.) See the more detailed analysis in a subsequent section- see page 39. Note that Malinda and her family are next to the household of Jacob Boyer and Mary Elizabeth (Snyder), John and Catherine Snyder's second daughter.

1		Johann Selander	28 f	William	✓		Ohio	
2		Samuel	18 m	Fanner	✓		Do	1
3		Margaret	14 f	Pamatic	✓		Do	1
4		Godhart	14 m				Do	1
5		Matthew	10 m				Do	
6	599	Jacob Boyer	28 m	Day labor	✓		Do	
7		Mary E	24 f				Penn	
8		John W	6 m				Indiana	
9		Martha	72 f				Ohio	
10		Laura Pembert	2 f				Do	
11	599	Ephraim Boyer	46 m	Fanner	✓	4,000	1,000	Maryland
12		Malinda	40 f				Penn	
13		Austin A	19 m	Do	✓		Ohio	1
14		William E	14 m	Do	✓		Do	1
15		Joseph V	14 m				Do	1
16		Lena	9 f				Do	1
17		Valentine Selander	76 m	Day labor	✓		Pennsylvania	

## 5.8 Death (1868 in Waldo, OH)

Valentine's burial: (<https://www.findagrave.com/memorial/216974498/valentine-selanders> : accessed 12 February 2023), memorial page for Valentine Selanders (1783–15 Jan 1868), Find a Grave Memorial ID 216974498, citing Waldo Cemetery, Waldo, Marion County, Ohio, USA; Maintained by Rebecca Johnson Oldham (contributor 47030689).

Rachel's burial: (<https://www.findagrave.com/memorial/216974779/rachel-selanders> ) : accessed 03 March 2023), memorial page for Rachel Selanders (28 Jul 1784–18 Sep 1859), Find a Grave Memorial ID 216974779, citing Waldo Cemetery, Waldo, Marion County, Ohio, USA; Maintained by Rebecca Johnson Oldham (contributor 47030689).

# Children of Johann Christian & Anna Maria Selanders

## 6 Francis (1789-1868)

Francis started life in Cumberland Co., PA, married there, and move eventually to Rock island,IL, where many of his younger offspring settled as well.

### 6.1 Birth (1786-1789)

Date inferred from other sources like the 1850 federal census enumeration and the findagrave memorial.

### 6.2 Marriage 11/29/1814

To Jane Brally in Mechanicsburg, PA, at Silver Spring Presbyterian Church - Historical Society of Pennsylvania; Philadelphia, Pennsylvania; *Historic Pennsylvania Church and Town Records*; Reel: 273. James Eccles & Mary Eccles were witnesses.

Register of Marriages		
Date	Persons united in Marriage	Persons present at the ceremony
1814 Oct. 6	Jacob Kellner to Rachel Procter	Henry R. Wilson.
27	Isaac Wynkoop to Mary Ellis	Samuel Giffen & Mrs. S. Giffen.
Nov. 24	Jacob Stock to Nancy Murray	Henry R. Wilson.
29	Francis Selander to Jane Brally	James Eccles and Mary Eccles.

Brally, Jane  
Married 29 Nov 1814 by Rev H. R.  
Wilson, Francis Selander &  
Jane Brally

# Children of Johann Christian & Anna Maria Selanders

## 6.3 Children

From <https://www.familysearch.org/tree/person/details/LCZY-TRQ> .

An example of children listed at ancestry also follows.



**Francis Solander**  
1786-1868 • LCZY-TRQ



Jane Brawley  
1796-1867 • LC3W-5ZY

Marriage  
29 November 1814  
Cumberland, Pennsylvania, United States

Children (6)



Catherine Solander  
1819-1878 • LBJQ-YYH



William A. Solander  
1821-1898 • LHJ6-WSX



Elizabeth Solander  
1822-1911 • LBJQ-67Q



Daniel Brawley Solander  
1827-1916 • KL6G-5Y5



Ann Jane Solander  
1830-1924 • LBJ7-QMY



George Augustus Solander  
1838-1911 • KHR3-N42



Catharine Solander  
1819-1878



William A Solander  
1821-1898



Elizabeth Solanders  
1822-1911



Daniel Brawley Solanders  
1827-1916



Ann Jane Solanders  
1830-1924



George Augustus Solanders  
1838-1911

### 6.3.1 Catherine (1819-1878)

Catherine married one Frederick Ditmer, possibly in the early 1840s. The 1840 census may show her living alone as follows with a young boy. See "United States Census, 1840," database with images, *FamilySearch* (<https://www.familysearch.org/ark:/61903/1:1:XHTY-6NP> : 30 September 2021), Cathrine Selanders, North Middleton Township, Cumberland, Pennsylvania, United States; citing p. 132, NARA microfilm publication , (Washington D.C.: National Archives and Records Administration, n.d.), roll ; FHL microfilm . OR, there is yet another Catherine Selanders to account for.

OF HEADS OF FAMILIES.	Males													FEMALES								
	Under 5	5-10	10-15	15-20	20-30	30-40	40-50	50-60	60-70	70-80	80-90	90-100	and upward.	Under 5	5-10	10-15	15-20	20-30	30-40	40-50	50-60	
Benjamin Thompson																						
Samuel Hammett																						
Abraham Young	2			1	1											1			1			
John Wise			1		2									1		1			1			
Wm. Marshall																						
Esther Selander			1																		1	

## Children of Johann Christian & Anna Maria Selanders

Catherine seems to have lived her entire married life in Pennsylvania. See:

<https://www.findagrave.com/memorial/123153930/catherine-ditmer>

(<https://www.findagrave.com/memorial/123153930/catherine-ditmer>: accessed 27 February 2023), memorial page for Catherine Solander Ditmer (14 Apr 1819–12 Feb 1878), Find a Grave Memorial ID 123153930, citing Dillsburg Cemetery, Dillsburg, York County, Pennsylvania, USA; Maintained by Peggy Bargen Duey (contributor 46873059).

It appears that all of her children stayed in the area of Dillsburg, PA, not far south of where she probably started life.

### **6.3.2 William (1821-1899)**

William was born in Pennsboro Twp, Cumberland County, 2/11/1821. Others as well have found that William married Lucy Lobaugh in 1844 in Carlisle, PA. In 1850 they are in Upper Allen Twp, Cumberland Co. By 1860 the family has started moving west through Illinois, ending up in Kansas. Familysearch shows 13 children! See <https://www.findagrave.com/memorial/94437859/william-solanders> and <https://www.familysearch.org/tree/person/details/LHJ6-WSX>.

### **6.3.3 Elizabeth (1822-1911)**

Others have found that Elizabeth was born 10/19/1822 in Shepherdstown, Cumberland Co. She married Samuel Bender in 1844 in Shepherdstown. They had five children and they moved west, ending up in Rock Island, Illinois.

### **6.3.4 Daniel (1827-1916)**

Daniel was born in Cumberland Co., PA, on 9/30/1827. He married Mary Jane McIvor in 1849 in Putnam Co., Illinois. They had a family of five children (all born in IL) and ended their lives divorced and in California. They must have been close to sister Elizabeth for a while as they lived in Rock Island, IL, for a while. Interestingly, the 1900 census indicates that his father was born in Switzerland and his mother in Scotland. This may point to the origins of the Xylander family name.

### **6.3.5 Ann Jane (1830-1924)**

Ann Jane was married in 1848 in Cumberland Co., PA, to Daniel Kline. After Daniel's death, she married Jacob Huber in 1854 in Illinois. They appear to have had six(?) children, and Jane was buried in Rock Island, IL. In 1860, her father Francis lived next to her.

### **6.3.6 George Augustus (1838-1911)**

George was born near Shepherdstoen, PA, on 5/14/1838. He married Mary E. Andres in 1867 in Rock Island, IL. They had three children, who all died in the Rock Island area.

# Children of Johann Christian & Anna Maria Selanders

## 6.4 Census Enumerations

### 6.4.1 1830 Census (Allen Twp, Cumberland Co.)

See <https://familysearch.org/ark:/61903/1:1:XHPR-JCF> .

	under 5	5 to 10	10 to 15	15 to 20	20 to 30	30 to 40	40 to 50	50 to 60	60 to 70	70 to 80	80 to 90	90 to 100	100, &c.	under 5	5 to 10	10 to 15	15 to 20	20 to 30	30 to 40	40 to 50	50 to 60	60 to 70	70 to 80	
Mic <sup>h</sup> l Boeklein			1	1	2											1		1						
John Dinkhuf	1	1				1									1	1		1						
Allen Floyd	2				1									1				1						
John Burdy								1																1
John Lupton				2	2		1	1									2	2					1	1
David Stealy	1		2	1	1		1								2	1	1		1					
John Frankentoye									1							1								1
Jacob Miller	1	1				1														1				
John Brumby					1																	1		
David Boeklein			1		1			1							1		2	1				1		
Samuel Stone	1	1	1			1								1	1	1					1			
Samuel Selander	1	1				1								1	1						1			

### 6.4.2 1840 Census (?)

Not found.

### 6.4.3 1850 Census (Upper Allen Twp, Cumberland Co.)

See <https://familysearch.org/ark:/61903/1:1:M4HW-4PW> .

	Orangeville	12	2																					
15	James Holanders	61	46			Laborer		200																
	Vance Holanders	51	24																					
	George Holanders	12	46																				1	1
	Warab Gollar	11	24																				1	

# Children of Johann Christian & Anna Maria Selanders

## 6.4.4 1860 census (Rock Island, Illinois)

See <https://familysearch.org/ark:/61903/1:1:MXHN-C3D>. Next to daughter Ann Jane and her family.

1317	1273	Francis Solanders	65	✓	None	800	350	Perm
		Jane Solanders	63	✓	Wife			No
		George Augustus "	22	✓	Day Laborer			No
1318	1374	Jacob R. Huber	28	✓	Carpenter		250	No
		Ann Jane "	29	✓				No
		George H. "	6/12	✓				No

## 6.5 Death (1868 in Rock Island)

3/27/1868 in Rock Island, Illinois. See . . .

Francis Solander

Birth: 1786 Pennsylvania, USA

Death: 27 Mar 1868 (aged 81–82)

Burial: Chippiannock Cemetery, Rock Island, Rock Island County, Illinois, USA

Memorial #: 215350706

Inscription: Aged 82 Yrs

BENDER/SOLANDER/HUBER family plot - south side of monument - located in South-central section of cemetery 07Sep2020

Family Members

Spouse: Jane Brally Solander 1797-1862

Children: Ann Jane Solander Huber 1830-1924

Created by: Dk Cotton (49654738)

Added: 7 Sep 2020

URL: <https://www.findagrave.com/memorial/215350706/francis-solander>

Citation: Find a Grave, database and images (<https://www.findagrave.com/memorial/215350706/francis-solander> : accessed 27 February 2023), memorial page for Francis Solander (1786–27 Mar 1868), Find a Grave Memorial ID 215350706, citing Chippiannock Cemetery, Rock Island, Rock Island County, Illinois, USA; Maintained by Dk Cotton (contributor 49654738).

# Children of Johann Christian & Anna Maria Selanders

## 7 Catherine (1795-1880)

### 7.1 Birth

I have found no record of Catherine's birth. She possibly the daughter of the elder Christian Selander. Perhaps she is the daughter of yet another Selander, but I have found no evidence in the US for any other Selander folks that would be contemporaries of Christian (elder).

### 7.2 Marriage (1816 – Silver Spring TWP, Cumberland Co., PA)

See Mechanicsburg ,Presbyterian, Silver Spring Presbyterian Church.

#### Source Citation

Historical Society of Pennsylvania; Philadelphia, Pennsylvania; *Historic Pennsylvania Church and Town Records*; Reel: 273. Source Information: Ancestry.com. *Pennsylvania and New Jersey, U.S., Church and Town Records, 1669-2013* [database on-line]. Lehi, UT, USA: Ancestry.com Operations, Inc., 2011. Original data: *Historic Pennsylvania Church and Town Records*. Philadelphia, Pennsylvania: Historical Society of Pennsylvania. *Methodist Church Records*. Valley Forge, Pennsylvania: Eastern Pennsylvania United Methodist Church Commission on Archives and History.

Register of Marriages		
Date	Persons united in marriage	Present at the ceremony
1816 Feb 8	Jonathan Talbot to Mary Uhler Alexander Fulton to Mary Seardorf	Fredrich Uhler and A. R. Wilson Thomas Wilson & Seardorf.
22	James Mulhall to Cath. Solander Thomas Wilson to Jane Ostair	John Wilson and James Eccles James Williams & George Brackett.

Mulhall, James  
married February 22, 1816 by Rev. Henry R.  
Wilson, James Mulhall to Catharine  
Solander.

Feb'y 22, 1816 Mulhall, James to Cath. Solander  
John Wilson & James Eccles

# Children of Johann Christian & Anna Maria Selanders

## 7.3 Children

### 7.3.1 Mary Ann (1817-1900)

Her birth is estimated to be 4/14/1817 in Cumberland Co., PA. She married John Boyd in 1845 in OH. They appear to have had six children, Mary Ann died in Ohio. See <https://www.familysearch.org/tree/person/details/27SL-LJF> .

### 7.3.2 John (1818-1899)

Birth is estimated as 10/8/1818 in Cumberland Co, PA, according to <https://www.familysearch.org/tree/person/details/9HJF-GRM> .

John married Maria Everly in 1843 in Holmes Co., OH. See . . ."Ohio Marriages, 1800-1958", database, *FamilySearch* (<https://familysearch.org/ark:/61903/1:1:XDNV-RLS> : 25 March 2020), John L. Munhall, 1843. See image 352.

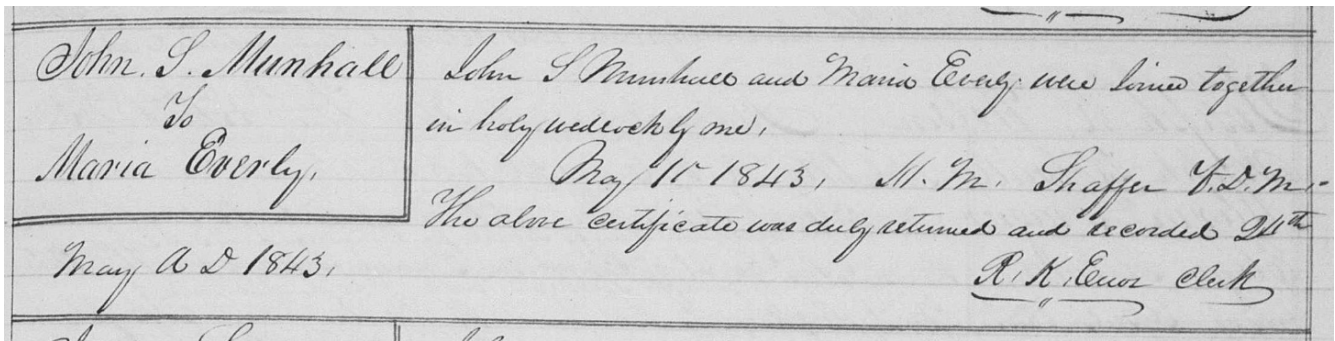

They had four children: Rhoda, Theresa, James H., and Leonard Francis.

Here is a record of his death. "Ohio Deaths and Burials, 1854-1997", database, *FamilySearch* (<https://familysearch.org/ark:/61903/1:1:F6ZT-2ZK> : 19 January 2020), John S. Mulhall, 1899. See image 276.

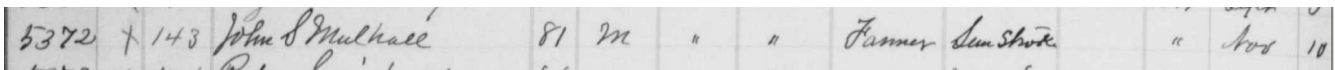

### 7.3.3 Elizabeth (1823-1904)

The birth of Elizabeth is listed as 8/13/1823 in <https://www.familysearch.org/tree/person/details/LVD8-2G7> . She married David Liggett in 1846 in Holmes Co., OH. They do not appear to have had



## Children of Johann Christian & Anna Maria Selanders

children. Elizabeth is buried in Wayne Co., OH, where she had lived with her husband. (<https://www.findagrave.com/memorial/74936211/elizabeth-m-liggett> )

### 7.3.4 James (1825-1905)

The birth date of 9/20/1825 in Cumberland Co., OH, is show in <https://www.familysearch.org/tree/person/details/LVD8-PMS> . James must have moved to Champaign Co., Illinois by 1850. He married Nancy Webber in about 1851, and they had 10 children there. He died in Urbana in 1905. (<https://www.findagrave.com/memorial/149211853/james-munhall> )

### 7.3.5 Sarah (1828-1919)

Sarah's birth is listed as 9/11/1828 in Cumberland Co., PA. She was married to Charles Yocum in 1854 in Holmes Co., OH. They had nine children. By the time of the 1870 census, they have moved to Warren Co., Missouri, where they already had seven children. The birth dates of the children indicate that the move to MO took place in roughly 1865. Sarah died in 1919 in the same county in MO. See <https://www.findagrave.com/memorial/81916383/sarah-yocum> .

### 7.3.6 Henry (1830-1855?)

Henry's death year is an estimate. He seems to have died in Urbana, IL, 3/27/1855. This means that he probably traveled there with his brother James.

### 7.3.7 Francis (1834-1855)

The birth date for Francis is listed as 9/25/1834 (Cumberland Co., PA) in <https://www.familysearch.org/tree/person/details/LVDD-MQB> . His death in Urbana, IL, on 3/11/1855 seems to indicate that he was there with brothers Henry & James. He died just a couple of weeks prior to Henry.



# Children of Johann Christian & Anna Maria Selanders

## 7.4.4 1850 Census (Holmes Co, OH)

See . . . Year: 1850; Census Place: Ripley, Holmes, Ohio; Roll: 696; Page: 314a (Use ancestry.)

871	911	James Mulhall	58	M	Yarn	1500	Pa		
		Wathore	56	F					
		Yurch	21	F					
		James	25	M	Carpenter				
		Henry	22	M	"				
		Francis	15	M			Ohio		

## 7.4.5 1860 Census (Holmes Co., OH)

See "United States Census, 1860", database with images, *FamilySearch* (<https://familysearch.org/ark:/61903/1:1:MCG3-PJQ> : 18 February 2021), Catharine Mulhall in entry for James Mulhall, 1860. - Next to son John.

83	1277/1201	John Mulhall	40	M	Yarn	3200	Pa		
84		Maria	37	F					
85		Reidy M	15	F			Ohio		1
86		Joseph	12	F					1
87		James	4	M					
88		James	4	M					
89	1278/1202	James	15	M	Yarn	200	Pa		
90		Catharine	65	F					

This indicates that the families were in Ohio by about 1845.

## Children of Johann Christian & Anna Maria Selanders

### 7.4.6 1870 Census (Holmes Co., OH)

See . . . Year: 1870; Census Place: Ripley, Holmes, Ohio; Roll: M593\_1224; Page: 180B; Family History Library Film: 552723

17	88	Mulhall James	74	M	W	Farmer			1815	Pennsylvania	/								/
		— Catharine	74	F	W	Keeping House				Pennsylvania	/	/	/						
	89	Mulhall John	32	M	W	Farmer	11200	1800		Pennsylvania									/
		— Maria	47	F	W	Keeping House				Pennsylvania									
		— Rhodah	25	F	W	Dress Maker				Ohio									
		— Emma	22	F	W	School Teacher				Ohio									
		— Leonard	14	M	W	At Home				Ohio									/
		— James	14	M	W	At Home				Ohio									/

See "United States Census, 1870", database with images, *FamilySearch* (<https://www.familysearch.org/ark:/61903/1:1:M62G-SCB> : 29 May 2021), Catherine Mulhall in entry for James Mulhall, 1870. - Living next to Son John.

17	88	Mulhall James	74	M	W	Farmer			1815	Pennsylvania	/								/
		— Catharine	74	F	W	Keeping House				Pennsylvania	/	/	/						
	89	Mulhall John	32	M	W	Farmer	11200	1800		Pennsylvania									/
		— Maria	47	F	W	Keeping House				Pennsylvania									
		— Rhodah	25	F	W	Dress Maker				Ohio									
		— Emma	22	F	W	School Teacher				Ohio									
		— Leonard	14	M	W	At Home				Ohio									/
		— James	14	M	W	At Home				Ohio									/

## 7.5 Death (1880)

See <https://www.findagrave.com/memorial/83192123/catherine-mulhall> – 4/29/1880 Holmes Co., OH.

# Children of Johann Christian & Anna Maria Selanders

## 8 Analysis: 1850 and 1860 Census for Marion Co., OH

The children of Rachel (Bruce) and Valentine Selander are documented in these enumerations below. First, here is the entry for Valentine and Rachel in 1850. Rachel dies in 1859 and Valentine moves in with daughter Malinda (Boyd).

fullName	sex	birthLikeDate	birthLikePlaceText	residenceDate	residencePlaceText	otherFullNames	famiID
Valentine Selander	Male	1782	Pennsylvania, United States	1850	Pleasant Township, Marion, Ohio, United States	Rachael Selander	5
Rachael Selander	Female	1787	Pennsylvania, United States	1850	Pleasant Township, Marion, Ohio, United States	Valentine Selander	6

Buy the way, I believe that this is Valentine and family in the 1810 census:

(Name: Vaulentine Selander

Event Date: 1810

Event Place: East Pennsboro, Cumberland, Pennsylvania, United States

Event Place (Original): East Pennsboro, Cumberland, Pennsylvania, United States

Event Type: Census

Page Number: 31

Affiliate Publication Number: M252

Affiliate Name: The U.S. National Archives and Records Administration (NARA)

Digital Folder Number: 005157097

Microfilm Number: 0193674

Image Number: 38

Citing this Record

"United States Census, 1810", database with images, *FamilySearch* (ark:/61903/1:1:XH2K-5PC : Mon Jul 18 14:53:02 UTC 2022), Entry for Vaulentine Selander, 1810. <https://www.familysearch.org/ark:/61903/1:1:XH2K-5PC>

)

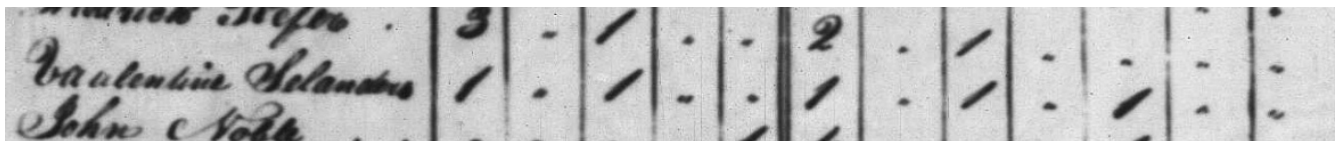

# Children of Johann Christian & Anna Maria Selanders

## 8.1 Ellen Selanders and Simon Culp

Note the names of the children, including Valentine and Melinda. I think that this is a pretty clear indication of their Selander heritage.

27	11	11	Simon Culp	49	M	Farmer	500	Pa
28			Ellen	19	F			Pa
29			Rachel	21	F			Pa
30			Caroline	18	F			Pa
31			Valentine	15	M			Pa
32			Melinda	12	F			O
33			Margret	9	F			O
34			Mary	4	F			O

Name: Simon Culp  
 Sex: Male  
 Age: 49  
 Event Date: 1850  
 Event Place: Waldo, Marion, Ohio, United States  
 Event Type: Census  
 Birth Year (Estimated): 1801  
 Birthplace: Pennsylvania  
 Race: White  
 Household Identifier: 11  
 House Number: 11  
 Line Number: 27  
 Schedule Type: 1850 Population  
 Affiliate Film Number: 708  
 Affiliate Publication Number: M432  
 Affiliate Name: The U.S. National Archives and Records Administration (NARA)

Household	Role	Sex	Age	Birthplace
Ellen Culp		F	49	Pennsylvania
Rachel Culp		F	21	Pennsylvania
Caroline Culp		F	18	Pennsylvania
Valentine Culp		M	15	Pennsylvania
Melinda Culp		F	12	Ohio
Margret Culp		F	9	Ohio
Mary Culp		F	4	Ohio
Samuel Merrick		M	22	Pennsylvania

Digital Folder Number: 004204493

# Children of Johann Christian & Anna Maria Selanders

Microfilm Number: 444701

Image Number: 00008

Indexing Batch: N01124-2

## Citing this Record

"United States Census, 1850," database with images, *FamilySearch* (<https://www.familysearch.org/ark:/61903/1:1:MXQL-MKH> : 21 December 2020), Simon Culp, Waldo, Marion, Ohio, United States; citing family , NARA microfilm publication (Washington, D.C.: National Archives and Records Administration, n.d.).

# Children of Johann Christian & Anna Maria Selanders

## 8.2 William Selanders and Ann (Boyer)

fullName	sex	birthLikeDate	birthLikePlaceText	residenceDate	residencePlaceText	otherFullNames
Sarah A Selander	Female	1860	Ohio, United States	1860	Waldo Township, Marion, Ohio, United States	Samuel Selander; Maria Selander; William P Selander; Hanah J Selander
William Sylander				1840	Richland Township, Marion, Ohio, United States	
William Selanders	Male	1807	Pennsylvania, United States	1850	Waldo, Marion, Ohio, United States	Ann Selanders; Samuel Selanders; Melinda Selanders; Mary Selanders; Valentine Selanders; Francis E Selanders; Sarah A Selanders
Ann Selanders	Female	1808	Pennsylvania, United States	1850	Waldo, Marion, Ohio, United States	William Selanders; Samuel Selanders; Melinda Selanders; Mary Selanders; Valentine Selanders; Francis E Selanders; Sarah A Selanders
Samuel Selanders	Male	1831	Pennsylvania, United States	1850	Waldo, Marion, Ohio, United States	William Selanders; Ann Selanders; Melinda Selanders; Mary Selanders; Valentine Selanders; Francis E Selanders; Sarah A Selanders
Melinda Selanders	Female	1833	Pennsylvania, United States	1850	Waldo, Marion, Ohio, United States	William Selanders; Ann Selanders; Samuel Selanders; Mary Selanders; Valentine Selanders; Francis E Selanders; Sarah A Selanders
Mary Selanders	Female	1836	Ohio, United States	1850	Waldo, Marion, Ohio, United States	William Selanders; Ann Selanders; Samuel Selanders; Melinda Selanders; Valentine Selanders; Francis E Selanders; Sarah A Selanders
Valentine Selanders	Male	1840	Ohio, United States	1850	Waldo, Marion, Ohio, United States	William Selanders; Ann Selanders; Samuel Selanders; Melinda Selanders; Valentine Selanders; Francis E Selanders; Sarah A Selanders
Francis E Selanders	Female	1843	Ohio, United States	1850	Waldo, Marion, Ohio, United States	William Selanders; Ann Selanders; Samuel Selanders; Melinda Selanders; Valentine Selanders; Francis E Selanders; Sarah A Selanders
Sarah A Selander	Female	1848	Ohio, United States	1850	Waldo, Marion, Ohio, United States	William Selanders; Ann Selanders; Samuel Selanders; Melinda Selanders; Valentine Selanders; Francis E Selanders; Sarah A Selander
William Selander	Male	1805	Pennsylvania, United States	1860	Waldo Township, Marion, Ohio, United States	Ann Selander; Frances E Selander; Sarah A Selander
Ann Selander	Female	1807	Pennsylvania, United States	1860	Waldo Township, Marion, Ohio, United States	William Selander; Frances E Selander; Sarah A Selander
Valentine Selander	Male	1839	Ohio, United States	1860	Waldo Township, Marion, Ohio, United States	Jacob Coleman; Alyjia Coleman; Emma Coleman
Frances E Selander	Female	1845	Ohio, United States	1860	Waldo Township, Marion, Ohio, United States	William Selander; Ann Selander; Sarah A Selander
Sarah A Selander	Female	1848	Ohio, United States	1860	Waldo Township, Marion, Ohio, United States	William Selander; Ann Selander; Frances E Selander

William's son Samuel and his wife Maria appear as follows in 1860.

fullName	sex	birthLikeDate	birthLikePlaceText	residenceDate	residencePlaceText	otherFullNames
Maria Selander	Female	1830	Ohio, United States	1860	Waldo Township, Marion, Ohio, United States	Samuel Selander; William P Selander; Hanah J Selander; Sarah A Selander
Samuel Selander	Male	1831	Pennsylvania, United States	1860	Waldo Township, Marion, Ohio, United States	Maria Selander; William P Selander; Hanah J Selander; Sarah A Selander
William P Selander	Male	1855	Ohio, United States	1860	Waldo Township, Marion, Ohio, United States	Samuel Selander; Maria Selander; Hanah J Selander; Sarah A Selander
Hanah J Selander	Female	1857	Ohio, United States	1860	Waldo Township, Marion, Ohio, United States	Samuel Selander; Maria Selander; William P Selander; Sarah A Selander
Sarah A Selander	Female	1860	Ohio, United States	1860	Waldo Township, Marion, Ohio, United States	Samuel Selander; Maria Selander; William P Selander; Hanah J Selander



# Children of Johann Christian & Anna Maria Selanders

## 8.3 Samuel A. Selanders and Sarah (Koph)

fullName	sex	birthLikeDate	birthLikePlaceText	residenceDate	residencePlaceText	otherFullNames
Samuel Sylander				1840	Pleasant Township, Marion, Ohio, United States	
Samuel Selanders	Male	1816	Pennsylvania, United States	1850	Waldo, Marion, Ohio, United States	Sarah Selanders; T H Selanders; Wm P Selanders; Mariah F Selanders; Samuel D Selanders; Emma A Selanders
Sarah Selanders	Female	1819	Pennsylvania, United States	1850	Waldo, Marion, Ohio, United States	Samuel Selanders; T H Selanders; Wm P Selanders; Mariah F Selanders
T H Selanders	Male	1840	Ohio, United States	1850	Waldo, Marion, Ohio, United States	Samuel Selanders; Sarah Selanders; Wm P Selanders; Mariah F Selanders
Wm P Selanders	Male	1842	Ohio, United States	1850	Waldo, Marion, Ohio, United States	Samuel Selanders; Sarah Selanders; T H Selanders; Mariah F Selanders
Mariah F Selanders	Female	1843	Ohio, United States	1850	Waldo, Marion, Ohio, United States	Samuel Selanders; Sarah Selanders; T H Selanders; Wm P Selanders
Samuel D Selanders	Male	1845	Ohio, United States	1850	Waldo, Marion, Ohio, United States	Samuel Selanders; Sarah Selanders; T H Selanders; Wm P Selanders; Mariah F Selanders; Emma A Selanders
Emma A Selanders	Female	1848	Ohio, United States	1850	Waldo, Marion, Ohio, United States	Samuel Selanders; Sarah Selanders; T H Selanders; Wm P Selanders
Samuel A Selander	Male	1818	Pennsylvania, United States	1860	Marion, Ohio, United States	Sarah Selander; Thadus Selander; William Selander; Maria J Selander; Samuel Selander; Amanda Selander; Elzina Selander
Sarah Selander	Female	1819	Pennsylvania, United States	1860	Marion, Ohio, United States	Samuel A Selander; Thadus Selander; William Selander; Maria J Selander; Samuel Selander; Amanda Selander; Elzina Selander
Thadus Selander	Male	1840	Ohio, United States	1860	Marion, Ohio, United States	Samuel A Selander; Sarah Selander; William Selander; Maria J Selander; Samuel Selander; Amanda Selander; Elzina Selander
William Selander	Male	1842	Ohio, United States	1860	Marion, Ohio, United States	Samuel A Selander; Sarah Selander; Thadus Selander; Maria J Selander; Samuel Selander; Amanda Selander; Elzina Selander
Maria J Selander	Female	1844	Ohio, United States	1860	Marion, Ohio, United States	Samuel A Selander; Sarah Selander; Thadus Selander; William Selander; Samuel Selander; Amanda Selander; Elzina Selander; John M Selander; James M Selander; Malinda Selander
Samuel Selander	Male	1846	Ohio, United States	1860	Marion, Ohio, United States	Samuel A Selander; Sarah Selander; Thadus Selander; William Selander; Maria J Selander; Amanda Selander; Elzina Selander
Amanda Selander	Female	1848	Ohio, United States	1860	Marion, Ohio, United States	Samuel A Selander; Sarah Selander; Thadus Selander; William Selander; Maria J Selander; Samuel Selander; Elzina Selander
Elzina Selander	Female	1852	Ohio, United States	1860	Marion, Ohio, United States	Samuel A Selander; Sarah Selander; Thadus Selander; William Selander; Maria J Selander; Samuel Selander; Amanda Selander
John M Selander	Male	1854	Ohio, United States	1860	Marion, Ohio, United States	Samuel A Selander; Sarah Selander; Thadus Selander; William Selander; Maria J Selander; Samuel Selander; Amanda Selander; Elzina Selander; James M Selander; Malinda Selander
James M Selander	Male	1855	Ohio, United States	1860	Marion, Ohio, United States	Samuel A Selander; Sarah Selander; Thadus Selander; William Selander; Maria J Selander; Samuel Selander; Amanda Selander; Elzina Selander; John M Selander; Malinda Selander
Malinda Selander	Female	1857	Ohio, United States	1860	Marion, Ohio, United States	Samuel A Selander; Sarah Selander; Thadus Selander; William Selander; Maria J Selander; Samuel Selander; Amanda Selander; Elzina Selander; John M Selander; James M Selander
Sylvester F Selander	Male	1860	Ohio, United States	1860	Marion, Ohio, United States	Samuel A Selander; Sarah Selander; Thadus Selander; William Selander; Maria J Selander; Samuel Selander; Amanda Selander

# Children of Johann Christian & Anna Maria Selanders

## 8.4 Malinda Selanders and Sylvester (Boyd)

1850: ("United States Census, 1850," database with images, *FamilySearch* (<https://www.familysearch.org/ark:/61903/1:1:MXQG-H8D> : 21 December 2020), Sylvester Boyd, Waldo, Marion, Ohio, United States; citing family , NARA microfilm publication (Washington, D.C.: National Archives and Records Administration, n.d.).)

Sylvester Boyd	36 M	Farmer	1300	Mo
Malinda	31 F			Pa
Oscar A	9 M			O
William	7 M			O
Joseph V	5 M			O
Francis J	15 F			O

1860: ("United States Census, 1860", database with images, *FamilySearch* (ark:/61903/1:1:MCGN-V2F : Sun Feb 12 19:38:42 UTC 2023), Entry for Sylvester Boyel and Malinda Boyd, 1860. <https://www.familysearch.org/ark:/61903/3:1:33SQ-GBSZ-ND5?view=index&personArk=%2Fark%3A%2F61903%2F1%3A1%3AMCGN-V2F&action=view&groupId=TH-1951-25270-8338-7> )

1	400 598	Sylvester Boyd	46 M	Farmer	✓	4,000	1,000	Maryland
2		Malinda "	40 F					Penn
3		Austin A "	19 M	Dr	✓			Ohio
4		William E "	16 M	Dr	✓			Do
5		Joseph V "	14 M					Do
6		Lena "	9 F					Do
7		Valentine Selander	76 M	Day labor	✓			Pennsylvania

fullName	sex	birthLikeDate	birthLikePlaceText	residenceDate	residencePlaceText	otherFullNames
Valentine Selander	Male	1784	Pennsylvania, United States	1860	Waldo, Waldo Township, Marion, Ohio, United States	Sylvester Boyd; Malinda Boyel; Austin A Boyd; William E Boyel; Joseph V Boyel; Lena Boyel

# Children of Johann Christian & Anna Maria Selanders

## 8.5 Suspicious Family of Henry and Susan Zowlander

fullName	sex	birthLikeDate	birthLikePlaceText	residenceDate	residencePlaceText	otherFullNames
Susan Zowlander	Female	1802	Ohio, United States	1850	Pleasant Township, Marion, Ohio, United States	Henry Zowlander; John Zowlander; Samuel Zowlander; William Zowlander; Jackson Zowlander
Henry Zowlander	Male	1803	Pennsylvania, United States	1850	Pleasant Township, Marion, Ohio, United States	Susan Zowlander; John Zowlander; Samuel Zowlander; William Zowlander; Jackson Zowlander
John Zowlander	Male	1828	Ohio, United States	1850	Pleasant Township, Marion, Ohio, United States	Henry Zowlander; Susan Zowlander; Samuel Zowlander; William Zowlander; Jackson Zowlander
Samuel Zowlander	Male	1829	Ohio, United States	1850	Pleasant Township, Marion, Ohio, United States	Henry Zowlander; Susan Zowlander; John Zowlander; William Zowlander; Jackson Zowlander
William Zowlander	Male	1831	Ohio, United States	1850	Pleasant Township, Marion, Ohio, United States	Henry Zowlander; Susan Zowlander; John Zowlander; Samuel Zowlander; Jackson Zowlander
Jackson Zowlander	Male	1840	Ohio, United States	1850	Pleasant Township, Marion, Ohio, United States	Henry Zowlander; Susan Zowlander; John Zowlander; Samuel Zowlander; William Zowlander

# Children of Johann Christian & Anna Maria Selanders

## 8.6 Summary Diagram (Tree)

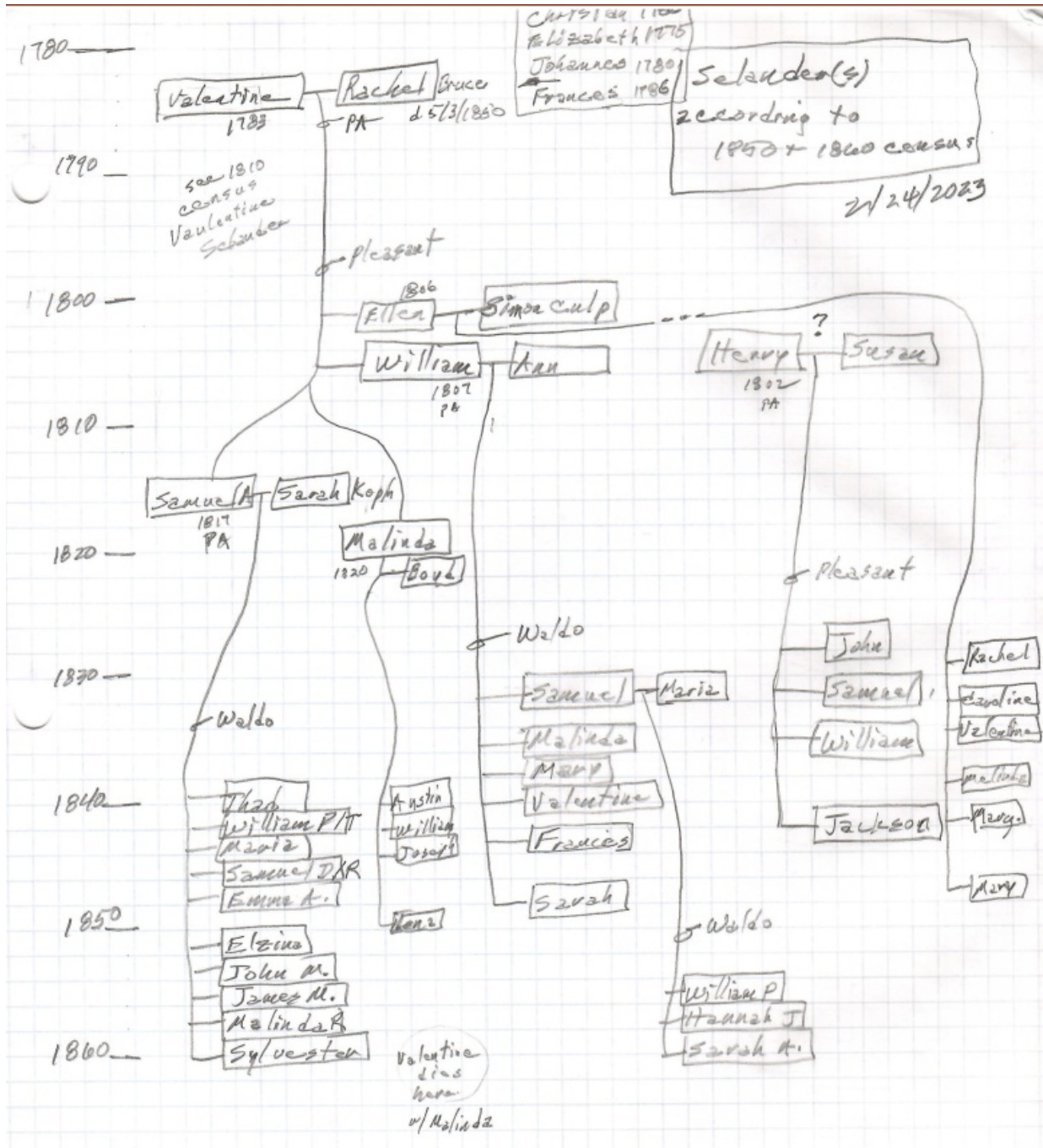

# John & Catherine Snyder - Clues

## Table of Contents

Introduction.....	3
Ohio Hints.....	5
1840 Census.....	5
John Snyder Query.....	5
Snyders in Marion County Query.....	10
Snyders in Delaware County Query.....	10
Daughter Susanna (Snyder) Loy.....	11
Daughter Elizabeth (Snyder) Boyer.....	11
Son George Snyder.....	15
Daughter Martha Snyder.....	16
1860 Census.....	16
1870 Census.....	18
Cemetery Records.....	19
Will/Probate Records.....	21
Jonathan Snyder.....	21
George Snyder.....	24
Jacob Boyer.....	32
William Selanders.....	34
A Delaware County Note.....	38
Land Records.....	39
Background.....	39
BLM Records.....	43
County Records.....	44
Marion County Search.....	45
Selanders Transactions.....	45
Snyder Transactions.....	46
Culp Transactions.....	47
Delaware County Search.....	49
Selanders Transactions.....	49
Snyder Transactions.....	49
Culp Transactions.....	49
1835 Male Residents.....	57
US Military District Bounty Lands.....	58
PA Hints.....	61
Birth in Cumberland County?.....	61
PA Direct Tax Lists 1798.....	64
East Pennsboro – Philip Snyder.....	66
Frankford – Phillip Snyder.....	67
PA Tax and Exoneration 1768-1801.....	69
East Pennsboro – Phillip Snyder.....	70
West Pennsboro – Phillip Snyder.....	72

# John & Catherine Snyder - Clues

PA Septennial Census 1779-1863.....	73
Phillip Snyder Examples.....	75
1793 Phillip Snyder in East Pennsboro Twp.....	75
1793 Phillip Snyder in West Pennsboro Twp.....	75
1800 Phillip Snyder in East Pennsboro Twp.....	76
1800 Phillip Snyder in Frankford Twp.....	76
1790-1830 Federal Census Enumerations.....	77
Selanders Families.....	77
Culp Families.....	78
Snyder Families.....	79
1790.....	79
1800.....	80
1810.....	81
1820.....	82
1830.....	83
Geographically Based PA Summary.....	85
Fundamentals.....	85
Western Records Cluster.....	87
Eastern Records Cluster.....	88
DNA Analysis.....	90
Autosomal Matching.....	90
Mitochondrial DNA.....	91
Conclusions.....	91

# John & Catherine Snyder - Clues

## Introduction

In two other documents I have described the results of research to indirectly establish the ancestors of John and Catherine Snyder, who are enumerated in the 1850 Marion Co., OH, census. (See <https://www.familysearch.org/ark:/61903/1:1:MXQL-MV2> .) These are 3<sup>rd</sup> great grandparents of mine. The indirect approach was suggested by the proximity of this Snyder family to three others with characteristics that looked very similar to those of the Snyder family. Those characteristics are . . .

- Parents born in PA prior to about 1810
- First children born in PA
- Subsequent children born in OH
- Implied migration to OH in 1832-1834
- Germanic names
- Proximity to the Snyder family in Waldo Twp, Marion County, OH, in 1850

The three families of greatest interest were all on the same page of the 1850 census: William & Anna Selanders, Simon & Ellen Culp, and Henry & Sarah Coleman. Of these three, I chose to investigate just the Selanders and Culp families. During these investigations, however, another possible connection between Selanders, Coleman, and Snyder families surfaced, and I will describe it later. (See the section starting at page 34.)

The results of the two investigations can be found in these documents: “Children of Johann Christian & Anna Maria Selanders” and “Simon Culp and Ellen Selanders of PA, OH, KS.” The research did not reveal a relationship between the Snyder and Selanders families, except that of proximity in OH in 1850. In the case of the Culp investigation, however, in addition to the physical proximity relationship, I discovered through DNA matching (using my mother’s DNA) that there is a clear relationship between the Snyder and Culp families. One generation back from John and Catherine Snyder and Simon Culp there was probably a common ancestor. The most likely scenario seems to be that one of Catherine Snyder’s parents (probably the father) was a Culp and that Simon (and his two brothers) were Catherine’s siblings. So far this is only a conjecture that needs to be proven/dis-proven.

Research did show a relationship between the William Selanders family and that of Simon Culp, however. So it is clear from conventional research and DNA mapping that these three families knew each other well. Here are some details in the context of the 1850 census.

## John & Catherine Snyder - Clues

The Snyder family in 1850 is shown below.

John Snyder	46	M	
Catharine	55	F	
Susanna	18	F	
Elizabeth	16	F	
George	15	M	
Martha	9	F	

Household	Sex	Age	Birthplace
John Snyder	M	46	Pennsylvania
Catharine Snyder	F	55	Pennsylvania
Susanna Snyder	F	18	Pennsylvania
Elizabeth Snyder	F	16	Ohio
George Snyder	M	15	Ohio
Martha Snyder	F	9	Ohio

The Culp and Selanders families are shown below. The fact that William Selanders' sister, Ellen, was Simon Culp's wife is called out. And, for possible future reference, the identity of William's wife (i.e., Anna Boyer) is noted. The Boyer surname appears later with the husband of the Snyder daughter Elizabeth shown above, but I have never been able to make a solid connection with this possible hint.

William Selanders	13	M	
Anna	12	F	
Harriet	10	M	
Katrina	7	F	
Katy	11	F	
Volentine	10	M	
George C	7	F	
Martha S	2	F	

**William Selanders (1806-1862) & Anna Boyer (1809-1892)**

**Simon Culp (1801-1892) & Ellen Selanders (1808-1903)**

Simon Culp	40	M	
Ellen	19	F	
Rebecca	21	F	
Caroline	18	F	
Volentine	15	M	
Katrina	12	F	
Margaret	8	F	
Mary	7	F	
Phineas	22	M	

(On the same sheet as the Snyder family in the 1850 census noted earlier.)

Details of the analysis that led to these bits of information can be found in the two documents noted above. The purpose of this document is explain the research that I have done to directly explore for the ancestors of John Snyder and to find the ultimate fate of John and Catherine.



# John & Catherine Snyder - Clues

## Ohio Hints

Following are descriptions of various attempts to find more information about the John and Catherine Snyder family from records in OH. The 1850 census implies that the family moved from PA in about 1832-1834, so there may be a census record in 1840 for the family. Since I have not found a death/burial record for either John or Catherine, it is possible that they are recorded in the 1860 census as well.

In addition, there are some relatively obscure grave site records from Marion County as well as will/probate information to review. There are summaries of what is known about each of the Snyder children identified in the 1850 census.

## 1840 Census

Following are descriptions of three attempts to find the family of John and Catherine in 1840.

### John Snyder Query

For this investigation, I looked at all census records for John Snyder (including name variants) across the entire state. One reason for doing this is that county boundaries changed between 1840 and 1850, and I did not want to overlook the fact that the Snyders may have appeared in a county other than Marion. Here is a link to an 1840 map of OH that shows county boundaries. Note that the village of Waldo is in Delaware County. <https://www.loc.gov/resource/g4080.ct011786/?r=0.219%2C0.382%2C0.408%2C0.179%2C0>



## John & Catherine Snyder - Clues

Here is a table that shows the results of the 1840 query. Of those 106 records, 102 seemed easy to reject and marked with an “x”, three were close and marked with a “c”, and one was closer than the others and marked with an “m”. In spite of all this, there is no clear match to the 1850 John and Catherine Snyder family in the 1850 census. The analysis took into account the ages of the various people as implied in the 1850 census - Susanna 8, Elizabeth 6, George 3, Martha unborn, John 36, Catherine 45. (All links must be prefixed with “<https://www.familysearch.org/>” to be useful.)

TWP	COUNTY	LINK	FULL NAME	status	Notes
Lewis Township	Brown	ark:/61903/1:1:XHRX-2W9	John Snider	x	
Lewis Township	Brown	ark:/61903/1:1:XHRX-27F	John Snider	x	
Perry Township	Brown	ark:/61903/1:1:XHRX-JBC	John Snider	x	
Madison Township	Butler	ark:/61903/1:1:XHRX-17B	John Snyder	x	
Madison Township	Butler	ark:/61903/1:1:XHRF-7S3	John Snyder	x	
Morgan Township	Butler	ark:/61903/1:1:XHRX-2GH	John Snyder	x	
Oxford Township	Butler	ark:/61903/1:1:XHRX-5FN	John Snyder	m	children right, wife too young?, why in western OH?
West Chester Township	Butler	ark:/61903/1:1:XHRF-WCL	John Snyder	x	
Orange Township	Carroll	ark:/61903/1:1:XHRX-RXT	John Snyder	x	
Bethel	Clark	ark:/61903/1:1:XHTR-K58	John B Snider	x	
Mad River	Clark	ark:/61903/1:1:XHTR-2S3	John Snider	x	
Pike Township	Clark	ark:/61903/1:1:XHTR-2X1	John Snyder	x	
Stonelick	Clermont	ark:/61903/1:1:XHTR-RKK	Snider	x	
Columbiana	Columbiana	ark:/61903/1:1:XHRF-8Z4	Jno A Snyder	x	
Lisbon	Columbiana	ark:/61903/1:1:XHRF-838	Jno Snyder	x	
Salem Township	Columbiana	ark:/61903/1:1:XHRF-HMR	John Snider	x	
Smith Township	Columbiana	ark:/61903/1:1:XHRF-3SN	John Snider	x	
West Township	Columbiana	ark:/61903/1:1:XHRF-S8Y	John Snider	x	
Clark Township	Coshocton	ark:/61903/1:1:XHRF-NLH	John C Snider	x	
New Guilford	Coshocton	ark:/61903/1:1:XHRF-FDM	John H Snider	x	
Bucyrus	Crawford	ark:/61903/1:1:XHYJ-5BD	John Snider	x	
Jackson Township	Crawford	ark:/61903/1:1:XHYJ-RXG	John Snyder	x	
Adams Township	Darke	ark:/61903/1:1:XHYV-QJL	John Snyder	x	
Gibson Township	Darke	ark:/61903/1:1:XHYV-3N5	John Snyder	x	
Lancaster	Fairfield	ark:/61903/1:1:XHTH-VF4	John S Snyder	x	
Walnut Township	Fairfield	ark:/61903/1:1:XHTH-2GB	J M Snyder	x	
Walnut Township	Fairfield	ark:/61903/1:1:XHTH-26K	John Snyder	x	
Wayne Township	Fayette	ark:/61903/1:1:XHTH-Z4W	John Snyder	x	
Franklinton	Franklin	ark:/61903/1:1:XHTH-XFW	John Snider	x	
Bath Township	Greene	ark:/61903/1:1:XHRF-5HK	John Snyder	x	
Beavercreek Township	Greene	ark:/61903/1:1:XHRF-R3X	Jonathan Snyder	x	
Beaver Township	Guernsey	ark:/61903/1:1:XHRN-38W	Jno Snider	x	

## John & Catherine Snyder - Clues

TWP	COUNTY	LINK	FULL NAME	status	Notes
Cincinnati	Hamilton	ark:/61903/1:1:XHRR-ZVS	John M Schneider	x	
Cincinnati	Hamilton	ark:/61903/1:1:XHRR- W3K	John Schneider	x	
Cincinnati	Hamilton	ark:/61903/1:1:XHRR-QC2	John Snyder	x	
Cincinnati	Hamilton	ark:/61903/1:1:XHRR-4DX	John Snyder	x	
Cincinnati	Hamilton	ark:/61903/1:1:XHRR-ZR8	John Snyder	x	
Cincinnati	Hamilton	ark:/61903/1:1:XHRR-417	John Snyder	x	
Cincinnati	Hamilton	ark:/61903/1:1:XHRR-3YK	John T Schneider	x	
Colerain Township	Hamilton	ark:/61903/1:1:XHRR-6Y2	J Snider	x	
Mill Creek Township	Hamilton	ark:/61903/1:1:XHRR- KNK	John Smider	x	
Sycamore Township	Hamilton	ark:/61903/1:1:XHRR-J17	John Snider	x	
Sycamore Township	Hamilton	ark:/61903/1:1:XHRR-JF6	John Snider	x	
Amanda Township	Hancock	ark:/61903/1:1:XHRN-71C	John Snider	x	
Green Township	Harrison	ark:/61903/1:1:XHRN-83D	John A Snider	x	
Monroe Township	Harrison	ark:/61903/1:1:XHRN-C22	John Snider	x	
North Township	Harrison	ark:/61903/1:1:XHRN-C3S	John Snider	x	
Laurel Township	Hocking	ark:/61903/1:1:XHYV-JCP	John Snyder	x	
Ripley Township	Holmes	ark:/61903/1:1:XHYV-KKP	John Snyder	x	
Berlin Township	Knox	ark:/61903/1:1:XHRN- GZQ	John Snyder	x	
Mount Vernon	Knox	ark:/61903/1:1:XHRN-GB1	John Snyder	x	
Etna Township	Licking	ark:/61903/1:1:XHTC-32X	John Snider	x	
Jefferson Township	Madison	ark:/61903/1:1:XHYK-STX	John Snider	x	
Pike Township	Madison	ark:/61903/1:1:XHYK-3K2	John Snider	x	
Gilead Township	Marion	ark:/61903/1:1:XHYK-4Z6	John R Snider	x	
Marion	Marion	ark:/61903/1:1:XHYK-7V1	Jonathan Snyder	x	
Montgomery Township	Marion	ark:/61903/1:1:XHYK-4KF	John Snyder	x	
Salisbury Township	Meigs	ark:/61903/1:1:XHBQ- CZM	John Snider	c	too many boys, girls not quite the right ages, wife too young?
Marion Township	Mercer	ark:/61903/1:1:XHBQ-ZZ6	John Snider	x	
Staunton Township	Miami	ark:/61903/1:1:XHBQ-VTJ	John Snyder	x	
Seneca Township	Monroe	ark:/61903/1:1:XHRN-T5Q	John Snider	x	
Dayton	Montgomery	ark:/61903/1:1:XHBQ-6C5	John A Snider	c	one too few girls
Dayton	Montgomery	ark:/61903/1:1:XHBQ- DLX	John Snider	x	
Jackson Township	Montgomery	ark:/61903/1:1:XHBQ-DX1	John Snider	x	
Jefferson Township	Montgomery	ark:/61903/1:1:XHBQ- DHY	John Snider	x	
Erie Township	Ottawa	ark:/61903/1:1:XHRR- 2WY	John Snyder	x	
Harris Township	Ottawa	ark:/61903/1:1:XHRR-2JD	John Snider	x	
New Franklin	Paris Township	ark:/61903/1:1:XHTT-65N	John D Snyder	x	

## John & Catherine Snyder - Clues

TWP	COUNTY	LINK	FULL NAME	status	Notes
Jackson Township	Perry	ark:/61903/1:1:XHRR-PYM	John Snyder	x	
Monday Creek Township	Perry	ark:/61903/1:1:XHRR-5MW	John Snyder	x	
Deer Creek Township	Pickaway	ark:/61903/1:1:XHRR-Y23	John Snider	x	
Scioto Township	Pickaway	ark:/61903/1:1:XHRR-B33	Jonathan Snider	x	
Walnut	Pickaway	ark:/61903/1:1:XHRR-RCK	John Snider	x	
Jackson Township	Preble	ark:/61903/1:1:XHRT-93D	John Snider	x	
Lanier Township	Preble	ark:/61903/1:1:XHRT-MVH	John Snider	c	ages not quite right, numbers good; why so far west
Ottawa Township	Putnam	ark:/61903/1:1:XHRT-4LP	John Snider	x	
Franklin Township	Richland	ark:/61903/1:1:XHTT-SWM	J M Snyder	x	
Madison Township	Richland	ark:/61903/1:1:XHTT-71T	John Snyder	x	
Mansfield	Richland	ark:/61903/1:1:XHTR-BPT	J N Snyder	x	
Plymouth Township	Richland	ark:/61903/1:1:XHTR-BTG	John Snider	x	
Sandusky Township	Richland	ark:/61903/1:1:XHTT-92V	John Snider	x	
Vernon Township	Richland	ark:/61903/1:1:XHTT-FPX	John Snyder	x	
Colerain Township	Ross	ark:/61903/1:1:XHTT-698	John Snider	x	
Madison Township	Scioto	ark:/61903/1:1:XHYT-9H7	John Snider	x	but look at all the Culp folks – Matolena, Henry, Washington, Tilman (PA) see <a href="https://www.familysearch.org/tree/person/details/LHM9-84R">https://www.familysearch.org/tree/person/details/LHM9-84R</a>
Clinton Township	Seneca	ark:/61903/1:1:XHYT-SV4	John Snider	x	
Canton	Stark	ark:/61903/1:1:XHTT-8KG	John Schneider	x	
Marlborough MM	Stark	ark:/61903/1:1:XHTT-HB2	John J Snyder	x	
Osnaburg Township	Stark	ark:/61903/1:1:XHTT-CB3	John Snyder	x	
Pike Township	Stark	ark:/61903/1:1:XHTT-44M	John Snyder	x	
Plain	Stark	ark:/61903/1:1:XHTT-CC1	John Snyder	x	
Hartford Township	Trumbull	ark:/61903/1:1:XHRJ-NMN	John Snyder	x	
Hubbard Township	Trumbull	ark:/61903/1:1:XHRJ-X81	John G Snyder	x	
Dover	Tuscarawas	ark:/61903/1:1:XHRJ-JNC	John Snyder	x	
Dover	Tuscarawas	ark:/61903/1:1:XHRJ-JFX	S J H Snyder	x	
Washington Township	Tuscarawas	ark:/61903/1:1:XHRJ-L3W	John Snyder	x	
Union Township	Warren	ark:/61903/1:1:XHRJ-57Q	Thos J Snider	x	
Salem Township	Washington	ark:/61903/1:1:XHRV-H7D	John Snyder	x	
Congress	Wayne	ark:/61903/1:1:XHTT-93J	John Snider	x	
Jefferson Township	Williams	ark:/61903/1:1:XHRV-7DX	John Snider	x	
Tiffin Township	Williams	ark:/61903/1:1:XHRV-7S1	John Snider	x	
Bloom Township	Wood	ark:/61903/1:1:XHRV-ZNX	John Snyder	x	
Middleton Township	Wood	ark:/61903/1:1:XHRV-CG3	John J Snider	x	

## John & Catherine Snyder - Clues

TWP	COUNTY	LINK	FULL NAME	status	Notes
	Crawford	ark:/61903/1:1:XHYJ-Y77	John Snyder	x	
	Marion	ark:/61903/1:1:XHYK-4L2	John Snyder	x	
	Richland	ark:/61903/1:1:XHTT-4NT	John Snider	x	
		ark:/61903/1:1:XHTR-5QB	John D Snider	x	

# John & Catherine Snyder - Clues

## Snyders in Marion County Query

Focusing just on people with the Snyder name who appear in the 1840 census in Marion County, a query produced the following list. The significance of this comes from the possibility that John Snyder was born as John Jacob Snyder. This is a conjecture that is explained later. Perhaps he occurs with a name other than John. Unfortunately, none of the families in the list look to me as if they are the family of John and Catherine Snyder.

ID	Name	Residence Place
ark:/61903/1:1:XHYK-7VL	Jacob Snyder *	Marion, Marion, Ohio, United States
ark:/61903/1:1:XHYK-7VG	George Snyder	Marion, Marion, Ohio, United States
ark:/61903/1:1:XHYK-7J6	Samuel Snyder	Marion, Marion, Ohio, United States
ark:/61903/1:1:XHYK-7JL	Henry Snyder	Marion, Marion, Ohio, United States
ark:/61903/1:1:XHYK-4L2	John Snyder **	Marion, Ohio, United States
ark:/61903/1:1:XHYK-4L1	William Snyder	Marion, Ohio, United States
ark:/61903/1:1:XHYK-7V1	Jonathan Snyder **	Marion, Marion, Ohio, United States
ark:/61903/1:1:XHYK-79M	Samuel Snyder	Pleasant Township, Marion, Ohio, United States
ark:/61903/1:1:XHYK-WY8	Peter Snyder	Canaan Township, Marion, Ohio, United States
ark:/61903/1:1:XHYK-QYL	Martin Snyder	Pleasant Township, Marion, Ohio, United States
ark:/61903/1:1:XHYK-W55	Jacob Snyder *	Scott Township, Marion, Ohio, United States
ark:/61903/1:1:XHYK-46G	Henry Snyder	Gilead Township, Marion, Ohio, United States
ark:/61903/1:1:XHYK-746	Christian Snyder	Richland Township, Marion, Ohio, United States
ark:/61903/1:1:XHYK-789	Jacob Snyder*	Grand Township, Marion, Ohio, United States
ark:/61903/1:1:XHYK-4KF	John Snyder**	Montgomery Township, Marion, Ohio, United States
ark:/61903/1:1:XHYK-QY3	Jacob Snyder*	Pleasant Township, Marion, Ohio, United States
ark:/61903/1:1:XHBQ-ZZ6	John Snider**	Marion Township, Mercer, Ohio, United States
ark:/61903/1:1:XHYK-4Z6	John R Snider**	Gilead Township, Marion, Ohio, United States

Notes:

\* Given name of Jacob. All investigated. None are reasonable matches.

\*\* Previously considered in section above.

Remaining entries were spot-checked and none appear to be reasonable matches.

## Snyders in Delaware County Query

A similar query for Delaware County yielded just two people, neither of whose families are candidates.

Name	Events
<b>George Snyder</b> United States Census, 1840	<b>Census</b> 1840 Delaware, Ohio, United States
<b>Elen M Snider</b> United States Census, 1840	<b>Census</b> 1840 Delaware, Delaware, Ohio, United States

# John & Catherine Snyder - Clues

## Daughter Susanna (Snyder) Loy

Susanna is my great-great grandmother. She married John Loy in March of 1857 and was gone from the scene some time between when the 1860 census was taken in July, 1860, and Dec., 1863, when John married Maria Augenstein. Presumably Susanna died during this three year period, but I have seen no record of her death. Susanna was John's third wife, and she cared for his children by his second wife, who incidentally were born in Baden. She and John had two children – Christina in 1857 and Sam in 1859. Sam is my great grandfather, and I have written about his life and that of his father in some detail.

Descendants of Susanna Snyder and John Loy are apparent in DNA testing at 23andme and ancestry. It is this data that has led me to Susanna's mtDNA haplogroup and the conclusion that the last daughter of John's is not with Susanna but perhaps with Maria Augenstein. (Susanna's mtDNA haplogroup and hence that for her mother Catherine is T2F1.)

*Aside: John/Johann Loy/Lay is an interesting character with a string of 4-5 wives during his roughly 72 years. He is a carpenter/cabinet maker from Baden. In Baden he first marries a cousin who dies in childbirth. Then he marries a widow, with whom he has five children – four that survive and make the voyage to the USA. Somewhere during the voyage or shortly after arrival (1853) the second wife disappears from the scene. John marries Susanna in 1857, and they have two children. In 1864 he marries Maria Augustine (probably Maria Augenstein), and Sarah Ann Loy is born in the same year. In the 1870 census, John appears in two entries for Van Wert Co. – in Jennings township with an obviously blended family of his children and those of a woman named Catherine from Hesse Darmstadt and in the village of Van Wert alone as a carpenter. In 1880 John is living solo in Lima, OH, and it appears that this Catherine is still living with children by another marriage in the village of Van Wert. John dies in 1892, having been living with his youngest daughter Sarah Ann (married to Samuel Archer) in Allen Co., OH. I suspect that the potential wife number 5 who appears in the 1870 Van Wert census is Catherine Klinger, who had been married to Samuel Louth. I am still working to verify the parts of this story with more concrete evidence than the census information.*

## Daughter Elizabeth (Snyder) Boyer

Susanna's sister, Elizabeth, was born in 1834 in OH. This was probably not long after the Snyder family had arrived in OH. In 1859, Elizabeth married Jacob Boyer.

Jacob had been married previously to a lady named Lucinda Tarr, with whom he may have had two children (John William and Mary Ellen). Jacob served in the Union Army. With Elizabeth he had five children (Lenora, Martha, Jacob, George, Samuel) from what I can tell.

I believe that this describes Jacob's father, John:

<https://www.familysearch.org/tree/person/details/L6YF-36H> .

## John & Catherine Snyder - Clues

Elizabeth's family appears in Waldo Twp in the 1860 census next to a family that includes Selanders folks (Malinda and Valentine). See <https://familysearch.org/ark:/61903/3:1:33SQ-GBSZ-ND5?cc=1473181&wc=7QGH-1CD%3A1589432777%2C1589422242%2C1589434029>.

6	599	597	Jacob Boyer	28	m		Day laborer	✓			Do		
7			Mary E "	24	f						Pruss		
8			John W "	1	m						Indiana		
9			Martha "	7 1/2	f						Ohio		
0			Linda Bamhart	2	f						Do		
11	400	598	Elizabeth Boyer	46	m		Fanner	✓	4,000	100	Maryland		
2			Malinda "	40	f						Pruss		
3			Austin A "	19	m		Do	✓			Ohio		1
4			William E "	16	m		Do	✓			Do		1
5			Joseph V. "	14	m						Do		1
6			Lina "	9	f						Do		1
7			Valentine Selander	76	m		Day laborer	✓			Pennsylvania		

In 1870 they have moved to Prospect Twp and John and Martha are not present. Children Jacob and George have been added, however. See <https://familysearch.org/ark:/61903/3:1:S3HY-678S-LSX?cc=1438024&wc=KL4X-829%3A518654901%2C518865401%2C519187201>.

190	200	Boyer Jacob	42	m	rr	Day Laborer
		— Elizabeth	35	f	rr	Keeping house
		— Elnora m	12	f	rr	
		— Jacob	6	m	rr	
		— George	2	m	rr	

In 1880 they are still in Prospect Twp and a new child (Samuel) has been added. George and Elenora are missing. See <https://familysearch.org/ark:/61903/3:1:33SQ-GYBK-9H19?cc=1417683&wc=X4TT-2NL%3A1589410656%2C1589397674%2C1589399105%2C1589395609>.

201	228	Boyer Jacob	W m 45		1	Farm hand	✓				Ohio		
		— Elizabeth	W f 35	wife	1	Keeping house					Ohio		
		— Jacob	W m 16	son	1	Farm hand	✓				Ohio		
		— Samuel	W m 1	son	1	at home					Ohio		



## John & Catherine Snyder - Clues

Luckily, a record from the 1890 census survives that shows Jacob. It confirms his service during the civil war, and it records the fact that he was wounded. The record indicates that he is living in Claridon, (Marion Co.,) OH. Here is the reference. "United States Census of Union Veterans and Widows of the Civil War, 1890," database with images, *FamilySearch* (<https://familysearch.org/ark:/61903/1:1:K83G-CXC> : 8 March 2021), Jacob Boyer, 1890; citing NARA microfilm publication M123 (Washington, D.C.: National Archives and Records Administration, n.d.); FHL microfilm 338,229.

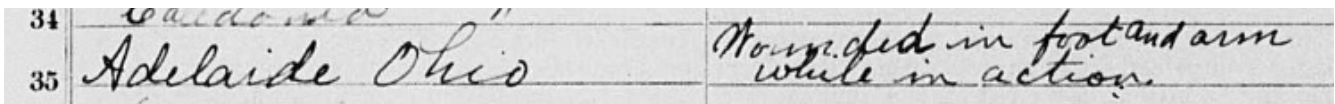
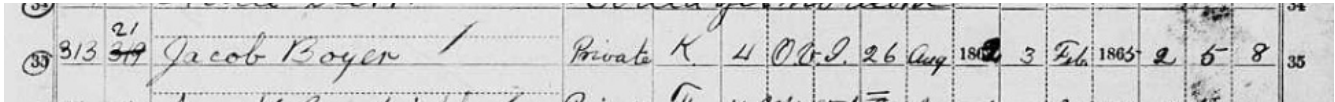

Note: Adelaide was another name for the village of Claridon according to the USGS place names tool. See <https://edits.nationalmap.gov/apps/gaz-domestic/public/search/names> and <https://edits.nationalmap.gov/apps/gaz-domestic/public/gaz-record/1056804>.

Variant Names			
Name	In Part	Originator	Reference
Adelaide	No	-	OH
Underwoods	No	-	OH
Wheaton	No	-	OH

Probably Elizabeth and Jacob were still living in Claridon, OH, in 1900. If so, then this is probably their record in the 1900 census - "United States Census, 1900," database with images, *FamilySearch* (<https://familysearch.org/ark:/61903/3:1:S3HY-67VZ-X1?cc=1325221&wc=9BW3-MNP%3A1030551701%2C1030809801%2C1035725701> : 5 August 2014), Ohio > Marion > ED 53 Claridon Township Caledonia Village > image 21 of 36; citing NARA microfilm publication T623 (Washington, D.C.: National Archives and Records Administration, n.d.).

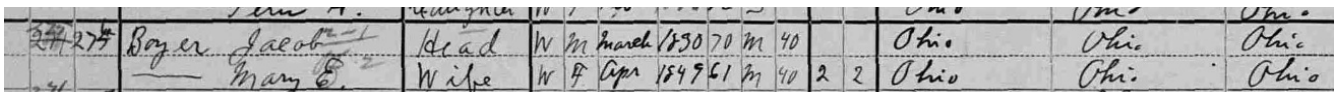

However, this would be inconsistent with a death record (March 1900) for Elizabeth. See "Ohio, County Death Records, 1840-2001," database with images, *FamilySearch* (<https://familysearch.org/ark:/61903/1:1:F662-JT5> : 1 March 2021), Elizabeth Boyer, Mar 1900; citing Death, Claridon, Claridon Township, Marion, Ohio, United States, source ID v 3 p 11, County courthouses, Ohio; FHL microfilm 384,350. This record shows her age as 61, which is about right. But, there is an entry later on the same page for Mary E. Boyer (death on 14-October-1900). This would be consistent with the 1900 Census. The problem with this, however, is that her age (53) is many years too young. The most that can be concluded with certainty is that Elizabeth died in 1900, after the census was taken in June of that year.

## John & Catherine Snyder - Clues

There is a likely headstone for Jacob shown in findagrave.com that was ordered in 1961 showing a death for Jacob in 1899. This date on the stone may be wrong based on the information from the 1900 census. See "Find A Grave Index," database, *FamilySearch* (<https://www.familysearch.org/ark:/61903/1:1:QVKX-VF6B> : 30 May 2020), Jacob Boyer, ; Burial, , ; citing record ID , *Find a Grave*, <http://www.findagrave.com>. The following record of burial may be the correct one. "Ohio, Grave Registrations of Soldiers, 1810-1955", database, *FamilySearch* (<https://www.familysearch.org/ark:/61903/1:1:D65L-R5N2> : 9 November 2020), Jacob S. Alias Boyer, Jacob Boyer, 1905. If so, then Jacob's death occurred in 1905 (after that of Elizabeth), and the 1900 census makes more sense.

Clearly the records are confusing, but it does appear that Jacob and Elizabeth ended their lives in the vicinity of Claridon some time around 1900-1905.

Along the way, I found no reasonable hint about the fate of John and Catherine Snyder. My indirect connection to Boyer descendants has been confirmed through DNA matching at ancestry.com using my mother's DNA.

# John & Catherine Snyder - Clues

## Son George Snyder

George was born in 1837 according to the 1850 census. I have found no credible records of a marriage or death. He was also of prime age for participating to the Civil War, but I have not clearly found him in military records. He maybe identified as Private George Snyder, who served from April, 1861, until September 25, 1862, in company H of the 4<sup>th</sup> Ohio Infantry. DNA testing has so far not yielded any clues. See pages 120 & 126 of the *Marion County Roll of Honor* -

[https://www.ogs.org/wp-content/uploads/resources/Active\\_1\\_of\\_4/mss00048f00034\\_oh\\_marion\\_civil\\_war\\_hardesty.pdf](https://www.ogs.org/wp-content/uploads/resources/Active_1_of_4/mss00048f00034_oh_marion_civil_war_hardesty.pdf) .

Snyder, Daniel....	"	B	136th O. N. G.....	May 2, '64....	Sept. '64.
Snyder, George....	"	B	64th O. V. I.....	'62.....	K. Stone R. Dec. 31, '62
Snyder, Daniel	"	D	89d "	Dec 31 61	

If this is indeed the right George Snyder, then he was killed near Murfreesboro, TN, at the Stones River Battle. See <https://www.nps.gov/stri/learn/historyculture/battle0.htm> . However, following may be the right record and it would show that he enlisted in the same unit (4<sup>th</sup> Ohio Volunteer Infantry) as brother in-law Jacob Boyer, who enlisted about two months after him. If this is the case, then George may have been fatally wounded at Antietam and died on the way to Harper's Ferry. See

<https://www.nps.gov/civilwar/search-battle-units-detail.htm?battleUnitCode=UOH0004RI01> .

Snyder, George....	"	H	4th " .....	April, '61....	Sept. 25, '62.
--------------------	---	---	-------------	----------------	----------------

Boyd, Wm. I. ....	Corporal ..	K	4th O. V. I. ....	June 6, '61....	
Booher, Daniel D..	Private ...	K	" " .....	" ..	
Boyer, Solomon ...	"	K	" " .....	" ..	
Boyer, Samuel ....	"	K	" " .....	" ..	
Boyer, Elias .....	"	K	" " .....	" ..	'64.
Boyer, Jacob .....	"	K	" " .....	" ..	Tr. 4th Ohio Battalion

# John & Catherine Snyder - Clues

## Daughter Martha Snyder

Martha was born in 1841 according to the 1850 census. That is the only record of her that I have found. Is it significant that her sister Elizabeth named a daughter born in 1860 Martha? Perhaps Martha died sometime between the 1850 census and 1860.

## 1860 Census

In 1860 I believe that John and Catherine's children are accounted for except Martha, who would be about 19 years old. Martha's siblings have either married or been killed in the Civil War. Unfortunately, I can find no record of her marriage or death. Since marriages are fairly well documented in the 1850s in Marion Co., I suspect that she may have died. Consequently, my best guess is that she died in the 1850s.

Given this suspicion, I looked for possible matches to the 1850 Snyder family of John and Catherine in 1860. In fact one family stands out. See <https://familysearch.org/ark:/61903/3:1:33SQ-GBSZ-FRG?cc=1473181&wc=7QGH-184%3A1589432777%2C1589422242%2C1589423641>.

John Snyder	63	m	Farmer	✓	240	80	Pennsylvania
Catherine	35	f					do
Margaret	18	f					Ohio

This family is in Pleasant Twp, and there are several discrepancies, so it may be a coincidence. The discrepancies compared to the 1850 census are . . .

- John is slightly too old (by 6 years)
- Catherine is too young (by 13 years!)
- Margaret should be Martha.
- The information about the family in the tree at familysearch.org is scattered and suspicious and probably largely wrong.

Probably this is not a match to the family of John and Catherine family in the 1850 census, but it is the closest match that I could find.

## John & Catherine Snyder - Clues

In the interest of completeness. Here is the full list of (9) Snyder people in 1860 in Marion Co., OH, where the birth location for the person is PA.

Name	Events	Relatio
<b>Catharine Snyder</b> United States Census, 1860	<b>Census</b> 1860 Pleasant Township, Marion, Ohio, United States <b>Birth</b> 1802 Pennsylvania, United States	
<b>Samuel Snyder</b> United States Census, 1860	<b>Census</b> 1860 Pleasant Township, Marion, Ohio, United States <b>Birth</b> 1807 Pennsylvania, United States	
<b>John Snyder</b> United States Census, 1860	<b>Census</b> 1860 Pleasant Township, Marion, Ohio, United States <b>Birth</b> 1798 Pennsylvania, United States	
<b>Nancy Snyder</b> United States Census, 1860	<b>Census</b> 1860 Pleasant Township, Marion, Ohio, United States <b>Birth</b> 1807 Pennsylvania, United States	
<b>Elizabeth Snyder</b> United States Census, 1860	<b>Census</b> 1860 Claridon Township, Marion, Ohio, United States <b>Birth</b> 1806 Pennsylvania, United States	
<b>Mary E Snyder</b> United States Census, 1860	<b>Census</b> 1860 Richland Township, Marion, Ohio, United States <b>Birth</b> 1791 Pennsylvania, United States	
<b>Geo Snyder</b> United States Census, 1860	<b>Census</b> 1860 Marion Township, Marion, Ohio, United States <b>Birth</b> 1801 Pennsylvania, United States	
<b>Christiana Snyder</b> United States Census, 1860	<b>Census</b> 1860 Marion Township, Marion, Ohio, United States <b>Birth</b> 1802 Pennsylvania, United States	
<b>Jacob Snyder</b> United States Census, 1860	<b>Census</b> 1860 Marion Township, Marion, Ohio, United States <b>Birth</b> 1805 Pennsylvania, United States	

# John & Catherine Snyder - Clues

## 1870 Census

Covering one more decade, I searched for John and Catherine Snyder in the 1870 census in Marion and Delaware Counties. The results of a query for Snyder people in Marion County, born in PA, yielded the following list of five people. None seem to apply. A similar query for Delaware County yielded no results (an empty set).

<b>Christina Snyder</b> United States Census, 1870	<b>Census</b> 1870 Marion Township, Marion, Ohio, United States <b>Birth</b> 1802 Pennsylvania, United States
<b>George Snyder</b> United States Census, 1870	<b>Census</b> 1870 Marion Township, Marion, Ohio, United States <b>Birth</b> 1801 Pennsylvania, United States
<b>Jacob Snyder</b> United States Census, 1870	<b>Census</b> 1870 Marion Township, Marion, Ohio, United States <b>Birth</b> 1807 Pennsylvania, United States
<b>John Snyder</b> United States Census, 1870	<b>Census</b> 1870 Pleasant Township, Marion, Ohio, United States <b>Birth</b> 1805 Pennsylvania, United States
<b>Nancy Snyder</b> United States Census, 1870	<b>Census</b> 1870 Pleasant Township, Marion, Ohio, United States

# John & Catherine Snyder - Clues

## Cemetery Records

A person with the Marion County, OH, Genealogy Society kindly supplied records from a local book of some burials that have not been recorded elsewhere and that might be of interest. Following is a copy of the cemetery information. "This book was done in the 1980 by a local couple who went to every cemetery not already recorded in another book.... and recorded the tombstones in all of these country cemeteries." I have added notes to some entries that are of potential interest. I do not see any clues regarding John and Catherine.

Pleasant Hill Cemetery, Big Island Twp

- Polly Snyder w/o John d. Dec 2, 18\*73 at 44y 2m 13d

Green Camp Cemetery, Green Camp Twp

- Caroline Snyder 2nd w/o Isaac d. Feb 6, 1891 at 65y 7m 16d
- Isaac Snyder d. Apr 15, 1881 at 41y
- Sarah Snyder 1st w/o Isaac d. Feb 12, 1872 at 27y

Likens Cemetery, Marion Twp

- Agnes Snyder b 1841 d 1927 w/o Jacob P.
- Elizabeth Snyder w/o Daniel d. May 2\*5, 184\*3 at 58y
- Fanny Snyder b. May 9, 1811 d. Apr 18, 1892 w/o Henry
- Henry Snyder b. May 15, 1809 d. Oct 8, 1841
- Infant Snyder s/o S. \* K. d. Oct 12, 1845
- Jacob P. Snyder b. 1834 d 1913
- Magdaline Snyder d. Apr 23, 1848 at 37y 7m
- Samuel K. Snyder b. Oct 16, 1836 d. May 3, 1848
- Steven Snyder b. Apr 7, 1862 d. Nov 6, 1862

New Bloomington Agosta Cemetery, Montgomery Twp

- Elizabeth Snyder b. 1848 d. 1905 w/o Gotthardt
- Gotthardt Snyder b. 1846 d. 1918
- Harley C. Snyder b. 1883 d. 1886

Mounts Cemetery, Pleasant Twp

- Charles Snyder s/o J. & B. d. Jun 27, 1843 at 15 y 14d
- Infant Snyder d/o J. & J.A. d. Sep 1844 at 20d
- John Snyder s/o J. & B. d. Sep 14, 1839 at 19y
- Margaret Snyder b. Oct 7, 1797 d. Mar 10, 1885 at 87y 5m 3d
- Samuel Snyder b. Jun 20, 1844 d. Sep 23, 1877 at 33y 3m

Pleasant Liberty Cemetery, Pleasant Twp

- Christina Snyder w/o Judge d. Jul 15, 1890 at 87y 7m 27d
- Cyrus T. Snyder s/o J.A. & S.A. b. Mar 19, 1845 d. 1861 at 15y 11m 28d
- Euphania Snyder d/o Samuel & Nancy d. Aug 2, 1840 at 1y 5m 12d
- George Snyder b. 1841 d. 1904
- George Jr Snyder Co.B 64 OVI d. Dec 31, 1862 at 28y 4m 28d
- Glaymont Snyder s/o Shannon & Sarah A. b. Jan 23, 1871 d. Nov 25, 1871
- Infant Snyder d/o Samuel & Nancy d. Jun 3, 1846
- Isaac Snyder d. Aug 5, 1860 at 32y 11m 13d
- Jonathan Snyder (dates underground)

# John & Catherine Snyder - Clues

- Judge Snyder d. Nov 8, 1879 at 78y 8m 3d
- Jus\_\_\_ Snyder d. May 15, 1888 at 19y 9m 14d
- Mary Ann Snyder (no dates) at 1y 1m 8d
- Mary E d/o Samuel & Nancy d. Jul 39, 1847 at 1m 23d
- Nancy Snyder w/o Samuel d. Aug 29, 1880 at 73y 5m 25d
- Samuel Snyder d. May 17, 1865 at 60y 2m 10d
- Sarah Snyder d. Jul 28, 1880 at 43y 5m 10d
- Sarah A. Snyder w/o J.A. d. Oct 28, 1869 at 48y 5m 10d
- Sarah A. Snyder b. Feb 9, 1844 d. Aug 11, 1871 w/o Shannon
- Susannah d. \_\_\_ 20, 1830 at 18y
- W. Shannon b. Oct 12, 1843 d. Sep 13, 1883

Collmer Cemetery,, Richland Twp.

- \_\_\_n J. Snyder d. Mar 23, 1853 at 64y

Neff Cemetery, Salt Rock Twp.

- Christann Snyder w/o Isaac d. Apr 22, 1859 at 53y 8m 25d

Waldo Cemetery, Waldo Twp.<sup>1</sup>

- Daniel Snyder b. 1881 d. 1887 s/o Frank & Sophia
- Elva Snyder d. 1885 s/o Frank & Sophia
- Nathan Snyder b. 1876 d. 1886 s/o Frank & Sophia
- Anna Selanders w/o W. d. Feb 10, 1892 at 82y 8m 23d
- Frances E. Selanders d. Oct 1, 1890 at 47y 1m
- Laura Selanders d/o V. & A. d. Oct 19, 1872 at 1y 18d
- Mary J. Brown Selanders b. 1841 d. 1919 w/o W.T.
- Otto Birchard Selanders s/o W.T. & M.J. d. Apr 4, 1880 at 3y 6m 8d
- Rachel Selanders w/o V. d, Sep 18, 1859 at 75y 1m 20d
- Valentine Selanders d. Mar 30, 1922 at 80y 10m
- W. T. Selanders d. Jun 4, 1885 at 43y 7m 17d
- William Selanders d. Feb 9, 1862 at 56y

Wolfinger Cemetery, Waldo Twp

- Elizabeth Snyder w/o M. d. Sep 12, 1883 at 73y 2m 2d
- Viola V. Snyder d/o M. & M. d. Dec 30, 1874 at 9d

Otterbein Cemetery, Prospect Twp.<sup>2</sup>

- Elmer Selanders s/o T.S. & M.E. d. Mar 30, 1871 at 1y 3m 8d
- Infant Sons Selanders sons/o T.S. & M.E. (no dates)
- Martha E. Selanders w/o T.S. d. Apr 25, 1871 at 23y 16d
- Martha J. Boyer d/o J. & M.E. d. Aug 26, 1869 at 9y 1m 20d

Boyer Cemetery, Marion Twp<sup>3</sup>

- Catherine Boyer w/o J. d. Mar 16, 1858 at 55y 5m 5d

Canaan Cemetery, Pleasant Twp.

- Molly Rozilda Boyer d/o H. & M. d. Sep 1, 1882 at 9y 10m 7d

---

1 The entries for Selanders people can be understood in the context of the separate document devoted to those families.  
2 See the footnote above regarding Selanders entries. Martha J. Boyer may be the daughter of Elizabeth (Snyder) Boyer and Jacob Boyer.  
3 Catherine Boyer is likely Catherine Klinefelter and wife of John Boyer. See will/probate information.



# John & Catherine Snyder - Clues

## Will/Probate Records

Marion County will/probate information follows for Jonathan and George Snyder, Jacob Boyer, and William Selanders. These were provided by the Marion Co. Genealogical Society, and they were selected based on possible relevance to John and Catherine Snyder. Unfortunately, there were no clues about John and Catherine, but the information is interesting in other terms.

## Jonathan Snyder

This Jonathan Snyder was born about 1805 in PA and moved to Marion Co., OH. He was Married to Margaret (Keagle?), and it appears that they had no children. He is the brother of the George Snyder whose will follows. Jonathan died in 1855 in Pleasant Twp and his findagrave memorial is 103818190. According to the 1840 census, they were somehow associated with Leander Harmon, whose relationship to them is not clear to me. See <https://familysearch.org/ark:/61903/3:1:S3HT-6QKQ-G8T?cc=1401638&wc=95RW-828%3A1031310001%2C1031358901%2C1031424601> . Here is probate case #399 from Marion Co.

Note: Jonathan and brother George may be related to Snyder families in the western cluster of PA records that is described in a later section, “Geographically Based Summary.”

# John & Catherine Snyder - Clues

In the name of the Benevolent Father of all:  
Know Ye, that I, Jonathan Snyder of the County of Madison  
and State of Mo. being of sound disposing mind and  
memory - do make and publish this my last will  
and Testament.

First  
It is my will that all my last debts be fully  
paid.

Second. It is my will that my Beloved wife Margaret  
have the sum of three hundred Dollars for her own use  
forever, to be pd. by my executor as soon as that amount  
may be collected, out of any money belonging to my  
Estate and said Margaret shall further, have the full  
use, control & possession of all my real estate during  
her natural life time, and said Margaret is to have  
all my household & kitchen furniture, and all provisions  
for the use of the family, one cow, one heifer & three pigs,  
all the corn in the crib & all feed I have on the farms I  
now live on, and all the wheat I have now on hand and five  
bushels of wheat which Edward McCaffer owes me, said  
McCaffer to deliver said bushels to my wife must have it, my said  
wife is to have said last mentioned items from Do. B. forever,  
and my said wife is to have the use of \$700 during her life  
time, my executor is hereby authorized & enjoined to pay to my  
said wife \$700 per annum being the use of the \$700 during her  
natural life time.

Fourth  
It is my will that my executor pay to Leander  
Harmon One hundred Dollars out of any  
money as soon as it may be collected.

Fifth It is my will that the balance of my personal  
Estate not otherwise disposed of be divided equally  
among my legal heirs & representatives, and after the

1855  
Jonathan  
Snyder  
wife Margaret  
Dr. George  
Leander  
Harmon

## John & Catherine Snyder - Clues

death of my said wife. the real estat I now hold  
be sold & with the bal of my personal estat be divided  
Equally among my legal heirs & representatives  
& my executor is hereby authorized to dig & complete a cistern  
at the North East corner of my house to be walled up with  
brick & well cemented, to hold hold 25 or 30 Bbls of water  
& put up a new porch on the North end of my house to  
run 6 feet further East than the house. the East part  
to be enclosed into a cook room. chimney in cook room,  
with shed over the cistern to be pd out of my estate,  
and to put & construct a good substantial  
Portico in front or on the south side of my house in  
in proportion to the house, or suitable to the house, the doors  
in the house to be fixed inside of the house to be well  
fixed, & the house to be well painted inside and  
out-side. and the cellar is to be well plastered,  
and my executor is to build & construct a small house  
8 ft by 10 ft, & to be finished off suitably for a small  
house.

With It is my will that my Brother George Snyder be is  
is hereby appointed my executor of this my last will and  
Testament. I hereby revoking all former wills by  
me made, said George Snyder is not to be required to give bail for the performance  
Maine Co. January 22, 1855. *J. Snyder* (Seal)

Signed sealed & declared by the said Jonathan Snyder  
of and for his last will & Testament in presence of us etc at  
his request and in his presence and in the presence of each  
other have subscribed our names as witnesses hereto.  
Maine Co. Jan/22/55. *John E. David*

# John & Catherine Snyder - Clues

## George Snyder

This seems to be the most likely George Snyder to be the brother of Jonathan (above). This is not certain, however. See this person in the family search tree:

<https://www.familysearch.org/tree/person/details/LDRF-ZTB> . Here is case 1430 from Marion Co.

Marion Co Ohio Probate Court - Case # 1430

I George Snyder: Publish and declare this to be my last will and Testament in the words and figures following to wit:

Item 1<sup>st</sup> It is my will: that all my just debts and funeral expenses: be fully paid =

Item 2<sup>nd</sup> I give to my wife: Christena Snyder, in lieu of her dower: and during her natural life: and the time she remains my widow: all my real and personal Estate, not herein otherwise disposed, and bequeathed:

Item 3<sup>rd</sup> It is my will that all of said Estate real and personal: so much as may remain at the death of my wife, and unexpended: real or personal: as the case may be and after the payment of her debts and funeral expenses be sold and equally divided among my heirs at Law

Item 4<sup>th</sup> It is my will that Executor proceed immediately after my death: to sell all my Bank Stock = and Rail Road Stock = Branch Road Stock = or any other stock = I may own and collect my outstanding and all dues to me wherever it may be: And all money on deposit or otherwise: And first pay to my said wife Five hundred Dollars \$500.00, the remainder to my heirs at Law = Equally divided = That said Executor shall pay dividends as soon as there shall be in his hands the sum of Fifteen hundred Dollars \$1500.00, and continues to do so until all is settled = Lastly = I hereby appoint my son Willson Shannon Snyder: to be the Executor of my will and Testament in Testimony thereof: hereby set my hand this 30<sup>th</sup> day of April, 1878

George Snyder

Attest: and declare this and no other to my last will and Testament

1878  
George Snyder  
Christena

son =  
Wilson Shannon  
Snyder

## John & Catherine Snyder - Clues

Codicil.

I, George Snyder, of Marion County, Ohio, having made my last will and testament on the 30<sup>th</sup> day of April A.D. 1876, do now hereby make and declare the following to be a Codicil to the same.

1. It is my will that my just debts and funeral Expenses be paid from the moneys which come to the hands of my Executor, hereinafter named, as provided in Item 1<sup>st</sup> of my said original will.
2. It is my will that at the death of my wife, my executor proceed to sell all such personal estate as shall be then remaining, and also all of my real estate wherever situated, and that of the proceeds of such sales he pay any debts my said wife may have left unpaid and her funeral Expenses and then distribute the remainder among my heirs at law according to their respective interests.
3. Should my said wife's debts and funeral Expenses be paid, either from the proceeds of the sale of the personal property left at her death, or, by my heirs, and should all of my said heirs agree upon an amicable division of my real-estate, then, it is my will that my Executor, by sufficient deed of Conveyance, convey to each of my said heirs, his or her portion of said real estate according to such amicable divisions, otherwise my

## John & Catherine Snyder - Clues

Said Executor is to sell all of said real estate without reserve.

4th. I do hereby nominate and appoint J. F. McNeal, of Marion, Ohio, the Executor of my original will and of this Codicil thereto, in the room and stead of my son William Shannon Snyder, heretofore named as my Executor, hereby authorizing said J. F. McNeal as such Executor to compromise, adjust, release and discharge, as he may deem most expedient and profitable to my estate, the debts and claims due to me. Whereof I have set my hand and seal this 16th day of July, 1879. *George Snyder*  
Signed and acknowledged by said Henry Snyder, as a Codicil to his last will and testament, in our presence; and signed by us in his presence.

Henry Coper  
J. M. Siderer

J. F. McNeal  
new executor

Filed  
Nov 18/79

# John & Catherine Snyder - Clues

In the Probate Court of Marion County, Ohio.

In the Matter of the Estate of George Snyder, deceased,  
late of Marion County, Ohio:-

Now comes John F. McNeal and represents to the Court that George Snyder, late of Marion County, Ohio, died testate, leaving Christena Snyder his widow, and the following named children and heirs at law, viz:- Elizabeth Myers, Wilson Shannon Snyder, Sarah J. Snyder, Nancy E. Bender, and Hannah Free, and that said testator named as the executor of his last will and testament the said John F. McNeal, who duly qualified and entered upon said trust, and that he as such executor has discharged the debts owing from said testator and distributed the balance of the proceeds remaining from the personal property ~~remaining~~ after the payment of the debts, to the persons entitled thereto in accordance with the provisions of said will.

That since the death of said George Snyder, the following named persons have also departed this life, viz: Christena Snyder, his widow. Wilson Shannon Snyder, intestate and without issue, Sarah Jane Snyder, intestate and without issue, and Nancy E. Bender, who left a minor daughter Myrtle Bender, and that her father William Bender is her guardian,

That said Myrtle Bender inherited from her mother Nancy E. Bender as well as from said Wilson Shannon Snyder and Sarah Jane Snyder, her proportionate share of their interest in said estate, and that the said Elizabeth Myers and Hannah Myers also inherited their proportionate share of the interest of said Wilson Shannon Snyder and Sarah Jane Snyder, and that the said Myrtle Bender by her guardian purchased the interest of Wilson Shannon Snyder in the real estate by him inherited from his father, which was sold to her at the sale made by his administrator, which makes the interest of said Myrtle Bender in said real estate the one half and the said Elizabeth Myers and Hannah Free each the one fourth.

That the last will and testament of George Snyder had the follow-

Christena Snyder X  
Elizabeth Myers X  
W. S. Snyder X  
Sarah J. Snyder X  
Nancy E. Bender X  
Hannah Free

Myrtle Bender

## John & Catherine Snyder - Clues

ing provisions therein, which are as follows:

"It is my will that at the death of my wife my executor proceed to sell all such personal estate as shall be then remaining and also all of my real estate wherever situate, and that of the proceeds of such sales he pay any debts my said wife may have left unpaid, and her funeral expenses and then distribute the remainder among my heirs at law, according to their respective interests."

"Should my said wife's debts and funeral expenses be paid, either from the proceeds of the sale of the personal property left at her death, or, by my heirs, and should all of my said heirs agree upon an amicable division of my real estate, then it is my will that my executor by sufficient deed of conveyance convey to each of my said heirs, his or her portion of said real estate according to such amicable division otherwise my said executor is to sell all of said real estate without reserve."

That the heirs of said George Snyder, deceased, have agreed upon an amicable division of the real estate of which said testator died seized, and have caused a survey to be made thereof, and assigned to each the portion which it was agreed among them should be held by each respectively.

To Myrtle Bender, the real estate described as follows, situate in the Township of Marion, County of Marion and State of Ohio, and known as being part of the North part of the south east quarter of Section thirty four (34), and the North part of the west half of the south west quarter of Section thirty-five (35), all in Township five (5) South Range fifteen (15) East: Bounded and described as follows, Beginning at the North East corner of the west half of the south west quarter of section thirty-five (35) Township and range aforesaid; thence west along the center of the road as now worked and travelled fifty-two and sixty five hundredths (52.65-100) chains to the center of the Marion and Delaware gravel pike; thence south eastward along the center of said pike

*land to Bender*



## John & Catherine Snyder - Clues

X twenty and seventy hundredths (20.70-100) chains; thence east twenty-five and thirty-nine hundredths (25.39-100) chains; thence south twelve (12) chains; thence east twenty one and sixteen hundredths (21.16-100) chains, to the east line of the west half of the south west quarter of Section 35; thence North on said line thirty two and thirty one hundredths (32.31-100) chains to the beginning containing one hundred and twenty-five and one half acres (125.1-2), more or less.

To Hannah Free, the following real estate, situate in the Township of Pleasant, County of Marion and State of Ohio, and being part of the North East quarter of Section three (3) and the North part of the west half of the North west quarter of section two (2) all in Township six (6) South Range fifteen (15) East; Beginning at the North East corner of the west half of the North west quarter of section two (2) Tp. and Range aforesaid; thence west with the township line sixty and twenty three hundredths (60.23-100) chains to the North west corner of the North East quarter of section three (3); thence with the half section line south ten and sixteen hundredths (10.16-100) chains; thence East nearly parallel with the township line sixty and twenty hundredths (60.20-100) chains to a point ten chains south of the beginning; thence North ten (10) chains to the beginning, containing sixty and one fifth (60.1-5) acres more or less.

*Lead to Free*

Also the following, Being the south west corner of the west half of the south east quarter of section thirty-four (34) Township five (5) Range fifteen (15) east, bounded as follows: Beginning at the south west corner of said south east quarter; thence North with the half section line three and twenty hundredths (3.20-100) chains; thence East to a point eight and eighty four hundredths chains, west of the Marion and Delaware gravel pike; thence parallel with said pike south nineteen degrees east to the township line; thence west on said line to the beginning, containing three (3) acres more or less, making in the

## John & Catherine Snyder - Clues

aggregate sixty three and one ~~fifth~~ acres more or less.

To Elizabeth Myers, the following real estate, situate in the Township of Marion, County of Marion and State of Ohio, and being part of the south part of section thirty four (34) and the south part of the west half of the south west quarter of section thirty-five (35) all in township five (5) south Range fifteen (15) East, Bounded and described as follows; Beginning on the township line at the south east corner of the west half of the south west quarter of section thirty-five (35) Township and Range aforesaid; thence on the Lot line North seven and seventy five hundredths (7.75-100) chains; thence west twenty one and sixteen hundredths (21.16-100) chains; thence North twelve (12) chains; thence west twenty five and thirty-nine hundredths (25.39-100) chains to the center of the Marion and Delaware gravel pike; thence with the center of said pike south easterly to the Township line, thence along said line east thirty nine and eighty six hundredths (39.86-100) chains to the beginning, containing fifty nine and ninety hundredths (59.90-100) acres more or less.

*Land to Myers*

Also, the following Being the south east corner of the west half of the south east quarter of section thirty four (34) Township and Range aforesaid; Bounded and described as follows, beginning where the center of the Marion and Delaware gravel pike crosses the township line; thence with the center of said pike North nineteen degrees west three and eighty hundredths chains (N.19 W.3.80) to the center of a private lane; thence with the center of said lane west eight and eighty four hundredths (8.84-100) chains; thence south nineteen degrees east parallel with the said pike; three and eighty hundredths (3.80-100) chains to the township line; thence along said line east eight and eighty four hundredths (8.84-100) chains to the beginning, containing three and one tenths (3.1-10) acres more or less, making in the aggregate sixty three (63) acres more or less.

*Land*

## John & Catherine Snyder - Clues

This petitioner further says that he is still the executor of the last will and testament of George Snyder, deceased, that said Christena Snyder the widow of said testator has departed this life, and that under the provisions of said will it now becomes his duty to make deeds to said several parties for the respective tracts that has been heretofore set out as agreed upon between them, that he as such executor has no funds in his hands with which to pay for said deeds, court costs, attorneys fees and compensation for his services, that he is now the administrator of the estate of Christena Snyder, deceased, and that the same heirs as named above are also the heirs of Christena Snyder, and that there is money in his hands belonging to said estate and more than what is required to pay her debts, and that there will be money in his hands for distribution on the final settlement of said estate.

Wherefore this petitioner prays for an order authorizing him to execute and deliver to said parties, as executor of the last will and testament of George Snyder, deceased, deeds for the respective tracts of land as above set forth and which was agreed among them as the proper division thereof, and that the court will order that out of moneys in his hands as administrator of the estate of Christena Snyder, deceased, he pay the court costs herein together with attorneys fees and compensation to himself for his services herein rendered, and that the court herein fix the amount of his attorneys fees and compensation, and for such other orders and relief as the nature of the case may require

John F. McNeal

By: *John F. McNeal* his attorneys.

The State of Ohio, Marion County, ss.

John F. McNeal being sworn says the allegations set forth and contained in the foregoing petition are as he believes true.

Sworn to before me by John F. McNeal, and by him subscribed in my presence this 2nd day of December A.D. 1890.

*John F. McNeal*  
*J. W. Lewis*  
Notary Judge

*1890*

# John & Catherine Snyder - Clues

## Jacob Boyer

Unfortunately, this person is NOT directly related to the Jacob Boyer who married Elizabeth Snyder. It is interesting in that the executor named is a Jacob Klinefelter. This is the maiden surname for Elizabeth Snyder's mother in-law. Jacob Klinefelter may be Elizabeth's uncle in-law. Perhaps this is a small world thing, but there may be some other significance.

The probate record (case 239) that follows is for the person

<https://www.familysearch.org/tree/person/details/LDKC-4NJ> described at family search. It is provided out of academic interest.

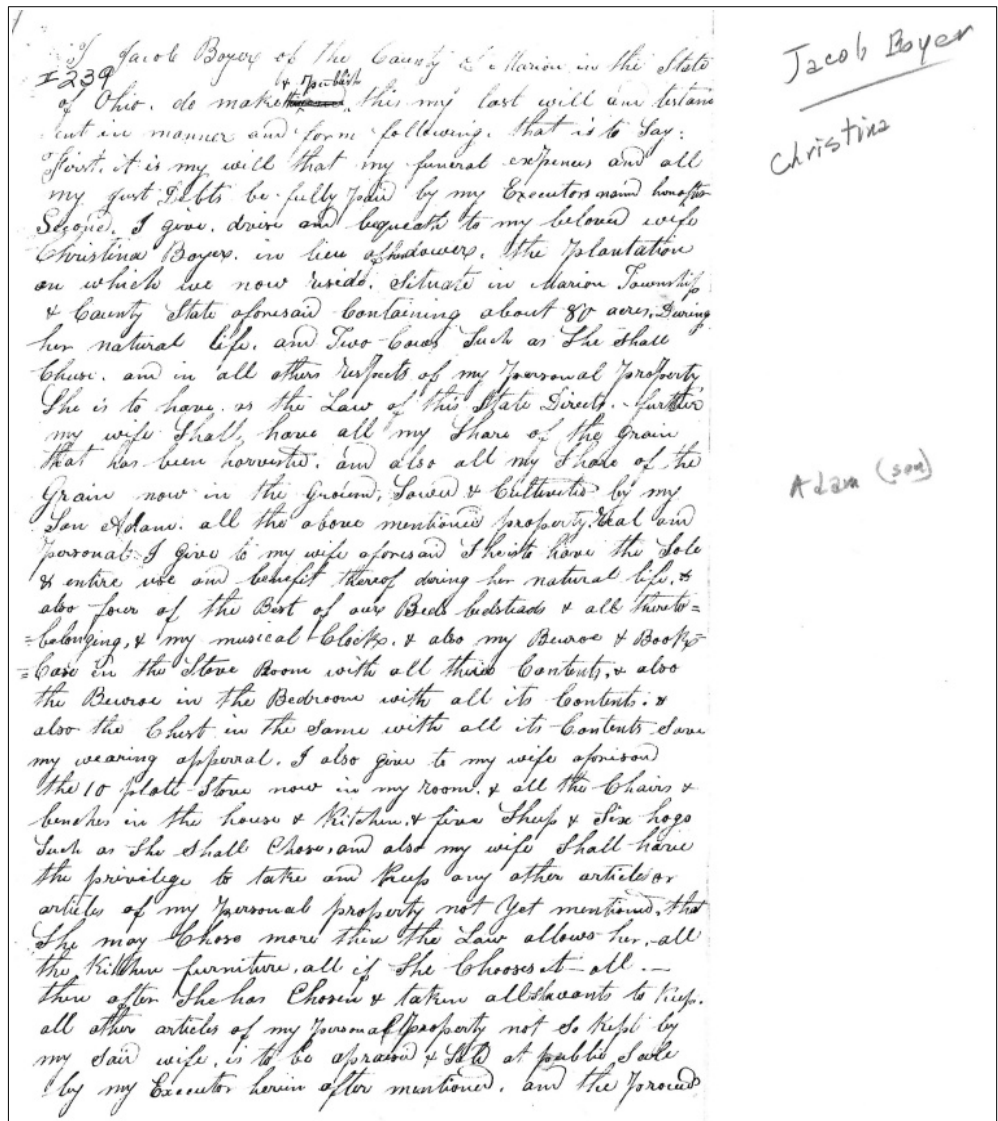

# John & Catherine Snyder - Clues

thereof is to be Divided as follows, after all  
 my Debts and other Expenses are paid, then my wife  
 preferred is to have the one third in full of the Ballance  
 and the other two thirds of the money is to be equally  
 Divided among my Children (to wit) To John Boyer, &  
 Elizabeth Gise, Mary Gable, Susanna Bartz, Christina  
 However & Jacob Boyer, & Maria Hains respectively, my son  
 Adam Boyer is not to have any more, he having received  
 his full Share of Legacy in the land I sold him -  
 And further, that at the Death of my said wife,  
 all the property hereby devised or bequeathed to her  
 as aforesaid, or so much thereof as may then remain  
 unexpended, is to be sold at public Sale by my  
 Executor, both Real Estate & Personal property, and after  
 all the Expenses are paid, then the proceeds, or money  
 arising out of said Sale, is to be Divided as follows,  
 to my six Children above named, all Sharing equal  
 Shares & Share alike, Except Christina However,  
 She is to have one Hundred Dollars less money  
 than any of the other five aforesaid out of this part  
 of my Estate, and Adam Boyer my son is not to have  
 any more money out of these Sales, for I have given  
 him the full Share of his Legacy in the land I  
 sold to him as aforesaid.

And lastly I hereby constitute and appoint  
 my trusty friend, Jacob Klinefelter to be the  
 Executor for this my last will and Testament.  
 In Testimony whereof, I have hereunto set my hand and  
 Seal this 26<sup>th</sup> Day of October AD 1847

Signed, published and declared  
 by the above named Jacob Boyer  
 as and for his last will and Testament,  
 in presence of us, who at his request  
 have signed as witnesses to the same  
 Christina Young  
 James Graham

Adam Boyer  
 John Boyer  
 Elizabeth Gise  
 Mary Gable  
 Susanna Bartz  
 Christina However?  
 Jacob Boyer

Jacob  
 Klinefelter  
 1847

# John & Catherine Snyder - Clues

## William Selanders

William's family was next to that of John and Catherine in the 1850 census. Here is a copy of probate case 606 from Marion County in 1862.

In the Name of God Amen  
 I Wm Selanders of the Township of Waldo County of  
Marion State of Ohio Being of Sound Mind and considering  
 the uncertainty of this life do therefore make and declare  
 this to be my will and Testament First After all  
 My debts are paid the residue of my estate real and  
 personal I give to My Beloved wife if She Survives  
 me also all Money or Notes which are in my favor for  
 the term of My said Wife Anna natural life and at  
 her death if there is So Much Left to Be disposed of  
 as follows My Daughter Melinda to have twenty dollars in  
 cash and the remainder of My Real and personal property  
 to be divided equally Between my other Sons and Daughters  
 to wit Alvine Samuel Valentine Mary Elize and Sarah  
 each to have equal Shares Like  
 Likewise I appoint My son in law Valentine Coleman (forwards) d. 1870  
 to be executor of this My Last will and testament

In witness I have hereunto Subscribed my name and  
 affixed My Seal this second Day of February in the year  
 of our Lord one thousand eight hundred and sixty two  
Wm Selanders 1862

Signed and Acknowledged by  
 Said Wm Selanders as his Last  
 will and Testament is our  
 presence and signed by us in  
 his presence

James Manasseth  
John Crawford 1862

William  
 Selanders  
 & Anna  
 Melinda  
 Alvine? Alvin + J-  
 Samuel + Mariah  
 Valentine + AE Myers  
 Mary + Valentine  
 Elize + ?  
 Sarah + Henry  
 Strick

Valentine Coleman  
 executor  
 (for in-law)

1862

At this point it is appropriate to point out another potentially significant clue regarding the inter-relatedness of the Selanders, Snyder, Culp, and Coleman families.) This was mentioned in the introduction.) The clue stems from an investigation into Valentine Coleman, the husband of Mary Selanders, daughter of William Selanders. Valentine is noted as the executor for William's estate in the probate case above.

## John & Catherine Snyder - Clues

The relationship of Valentine to the Selanders family was noted in the document summarizing research into the Selanders families. See the section devoted to William Selanders, part of which I repeat here.

“

- **Mary** (b.~1836 in OH) married Valentine Coleman in Delaware Co., OH, in 1854. Mary and Valentine's marriage is recorded here <https://www.familysearch.org/ark:/61903/1:1:X8FM-S7Q>.

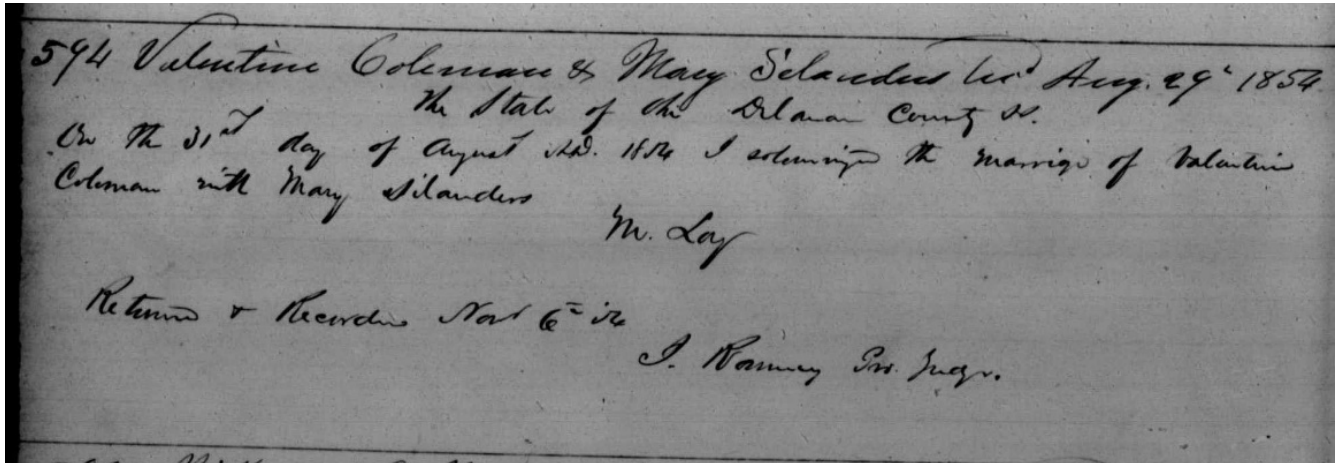

Valentine Coleman served as executor for William Selanders' estate. Valentine is somewhat older than Mary (by 6 years). He and Mary and their children are likely listed in the 1850 census next to his possible father (John) as follows. See "United States Census, 1850," database with images, FamilySearch (<https://www.familysearch.org/ark:/61903/1:1:MXQL-HSM> : 21 December 2020), Valentine Coleman, Waldo, Marion, Ohio, United States; citing family , NARA microfilm publication (Washington, D.C.: National Archives and Records Administration, n.d.).

21	21	Valentine Coleman	34	M	Farmer	900	Pa	
		Mary	28	F			0	
		William	6	M			0	
		Eizabeth	5	F			0	
		Catharine	1	F			0	
25	25	John Coleman	63	M	Farmer	3500	Pa	
		Barbra	35	F			Germany	
		Barbra	17	F			0	1
		Susan	15	F			0	1
		Frederick	12	M			0	1





# John & Catherine Snyder - Clues

living with the Valentine Coleman born in 1889. Presumably this third Valentine is the son of the eldest Valentine, and he is the one that married Mary Selanders. A quick search of familysearch.org reveals this person - <https://www.familysearch.org/tree/person/details/LKR4-3BX> . The first son of Mary and Valentine is named Henry, but he can not be the one that appears near near the Snyder and Selanders families in the 1850 census. The correct person is shown here - <https://www.familysearch.org/tree/person/details/L71P-K9G> . This Henry appears to be the son of John Coleman (b.1786) and Catherine Snyder (b.1795). I suspect that John Coleman (b.1786) and Valentine Coleman (b.1789) were both sons of Valentine Coleman (b.1755) and Margdalena Spengler (b.1761). So, the Valentine Coleman that is executor in the will above is a cousin to Henry Coleman who lived near William Selanders, John Snyder, and Simon Culp. It is a somewhat twisted story, but it demonstrates that these families were geographically close in PA and OH, and they intermarried.

Here are pictures of trees to illustrate the possible relationships. It is a complicated group, and I suspect that there are errors in the trees, but it illustrates the possible connection of Snyder and Coleman families. It may help explain the proximity of the families in Waldo Twp on 1850.

First, a tree that leads to Henry Coleman in the 1850 census. See <https://www.familysearch.org/tree/pedigree/landscape/L2SM-MQ7> . It hints at a Snyder/Coleman connection.

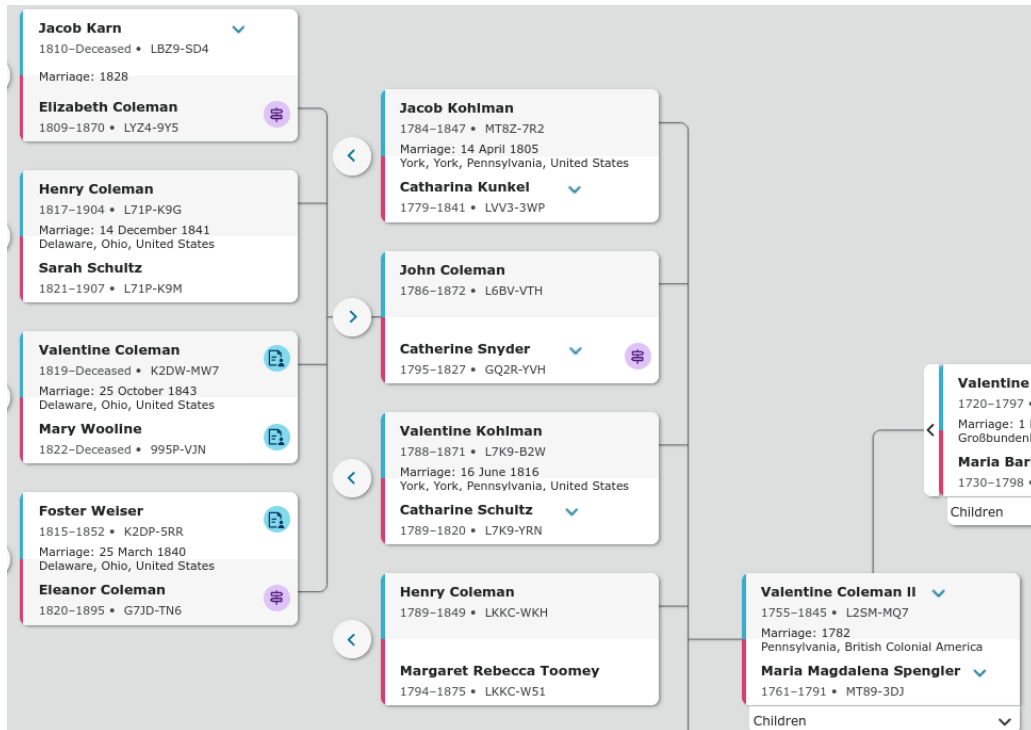

# John & Catherine Snyder - Clues

Second, a tree that leads to the Valentine Coleman mentioned in William Selanders' will. (Mary Selanders' birth date should be 1836-1837.) See

<https://www.familysearch.org/tree/pedigree/landscape/LKR4-3BX>

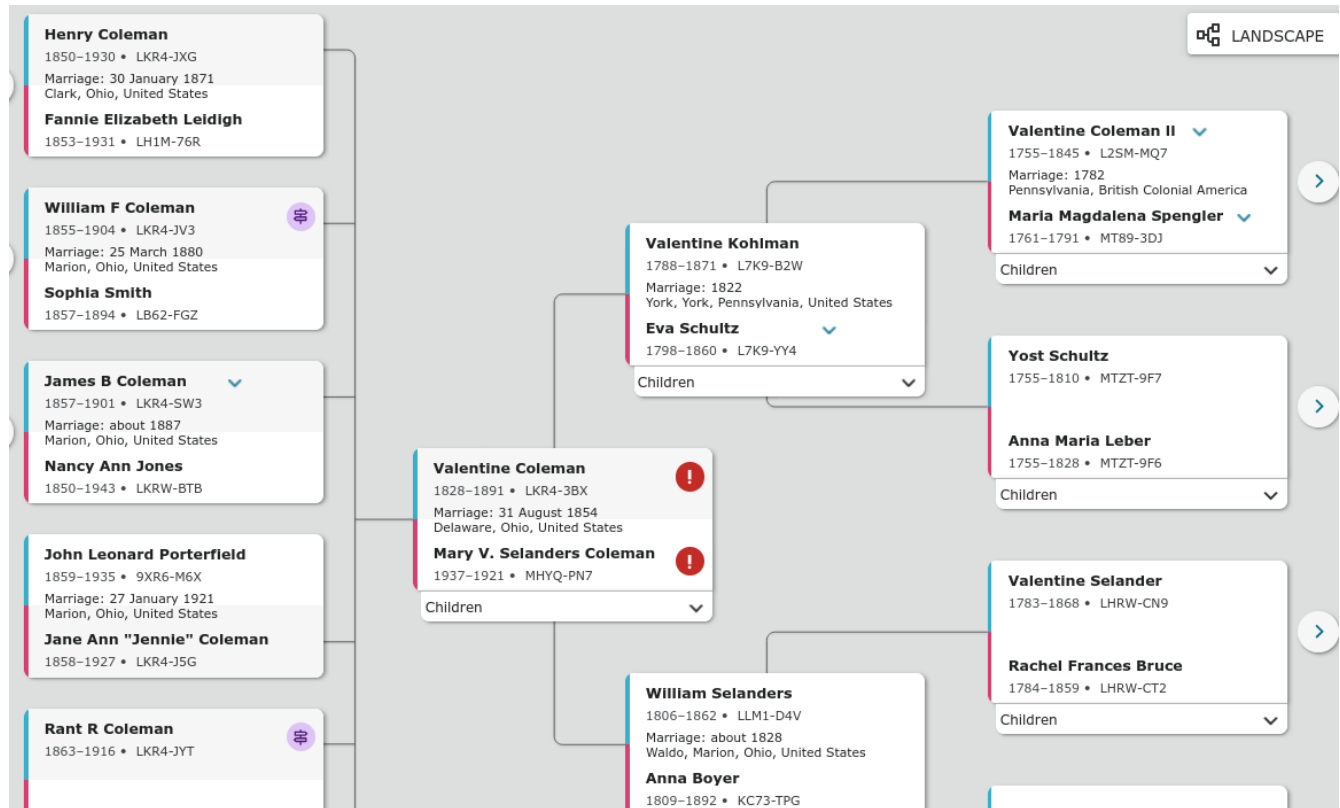

## A Delaware County Note

A search of probate records held by Delaware County yielded just one item. The case involved John D. Snyder in 1859. This man (along with others) was brought before the court for selling illegal alcoholic beverages. He was a resident of Delaware. Because of this and the fact that I did not recognize his fellow offenders, I have assumed that this does not describe the John Snyder that I am researching.

# John & Catherine Snyder - Clues

## Land Records

### Background

The area of interest in Waldo Twp (Marion County) is a complicated area in terms of how it was originally subdivided and made available to “settlers” after it was taken from native tribes. Its boundaries now (and in 1850) are shown below in red in the context of Marion and surrounding counties. (See [https://www.co.marion.oh.us/?page\\_id=1554](https://www.co.marion.oh.us/?page_id=1554) .) These boundaries have been in effect since about mid-1848.

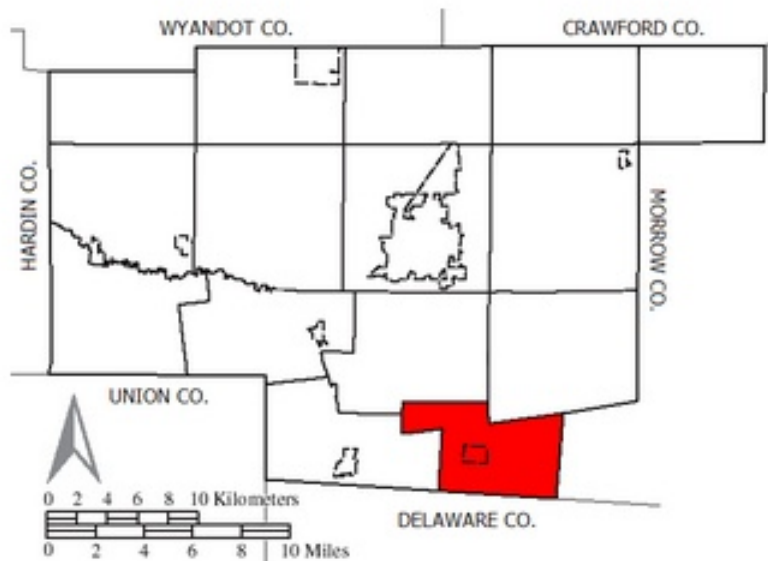

In the roughly 15 years prior to that, when the Snyder, Selanders, Culp, etc. families lived after coming from PA, however, the county boundary between Delaware and Marion Counties appeared as follows. See

<https://digital.newberry.org/ahcb/map/map.html#OH> .

Note the diagonal boundary running from SW to NE. This represents the Treaty of Greenville Line. (See [https://en.wikipedia.org/wiki/Treaty\\_of\\_Greenville](https://en.wikipedia.org/wiki/Treaty_of_Greenville) .)



# John & Catherine Snyder - Clues

The following map shows the area in about 1849 in more detail. See [https://www.ohiohistory.org/wp-content/uploads/2022/01/Eaton-s\\_Map\\_of\\_Delaware\\_County\\_1849.pdf](https://www.ohiohistory.org/wp-content/uploads/2022/01/Eaton-s_Map_of_Delaware_County_1849.pdf) . The first view is just east of the village of Waldo. The second shows the area just west of Waldo.

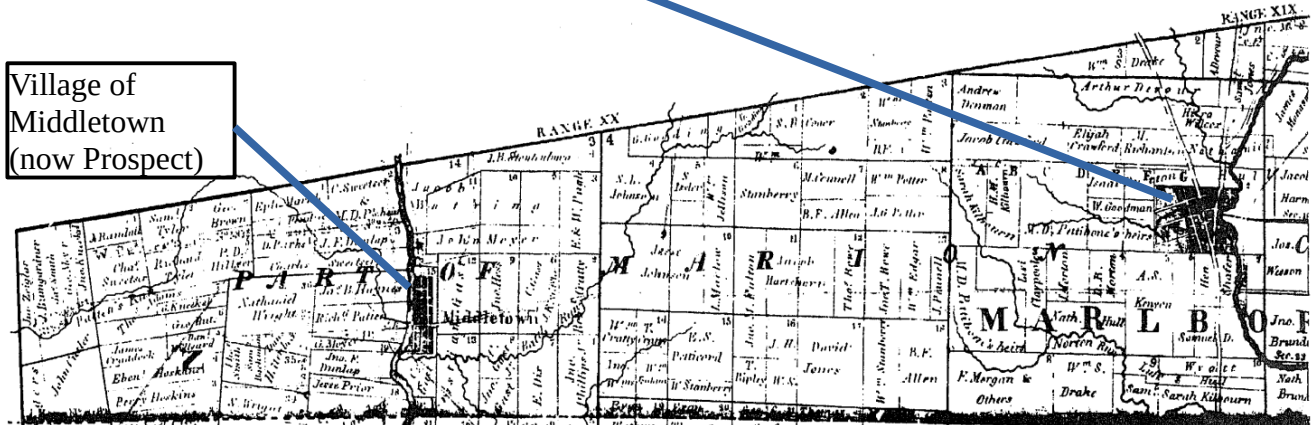
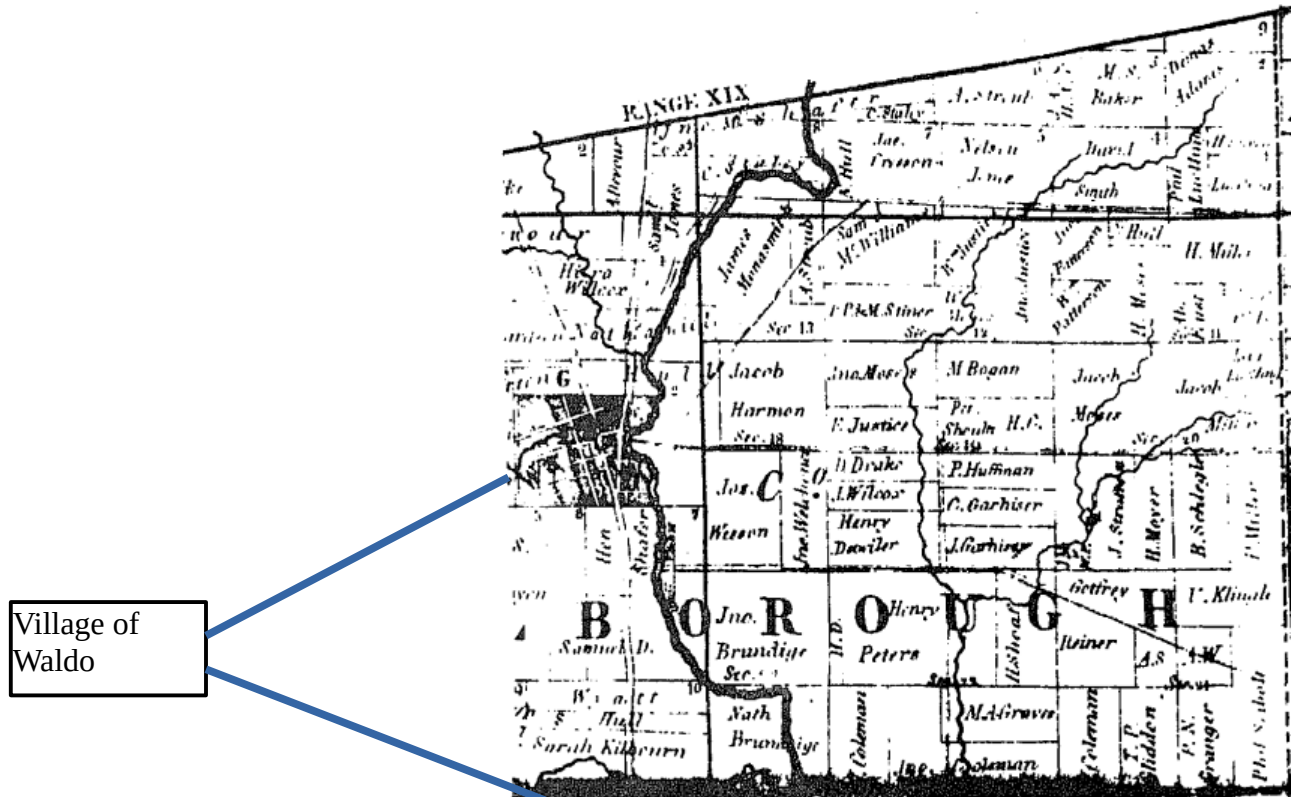

These images depict the wedge shaped area administered by Delaware Co. and then Marion Co. The “Range XIX” and other similar labels describe one aspect of how this area was subdivided when taken from native tribes. The area is part of the U.S. Military District, described here - [https://en.wikipedia.org/wiki/United\\_States\\_Military\\_District](https://en.wikipedia.org/wiki/United_States_Military_District) and here

# John & Catherine Snyder - Clues

[https://www.ohiohistorycentral.org/w/index.php?title=United States Military District](https://www.ohiohistorycentral.org/w/index.php?title=United_States_Military_District) . The next image illustrates how this area fits into the complicated division of land in OH. See <https://ohiohistory.libguides.com/land/divisionmaps#s-lg-box-16325806> .

Ohio Land Divisions Map

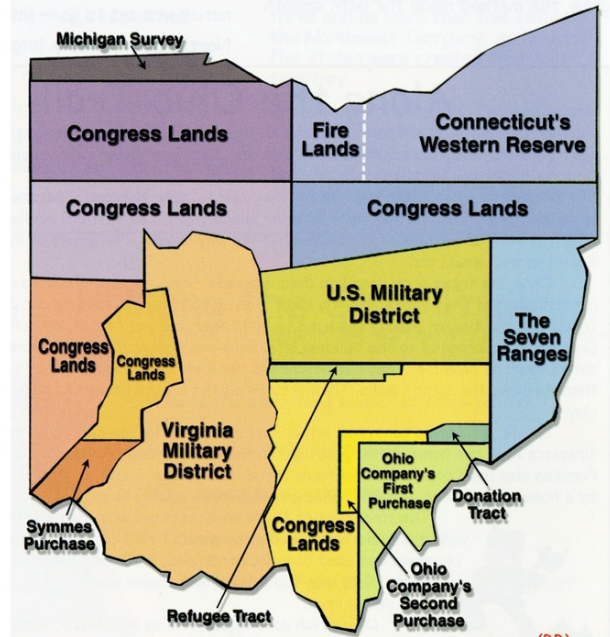

The subsequent image shows the U.S. Military District in more detail. Note the way in which Township and Range values are assigned. The area of interest for this research is in the NW corner of the map – ranges XX, XIX, and XVIII and township 7.

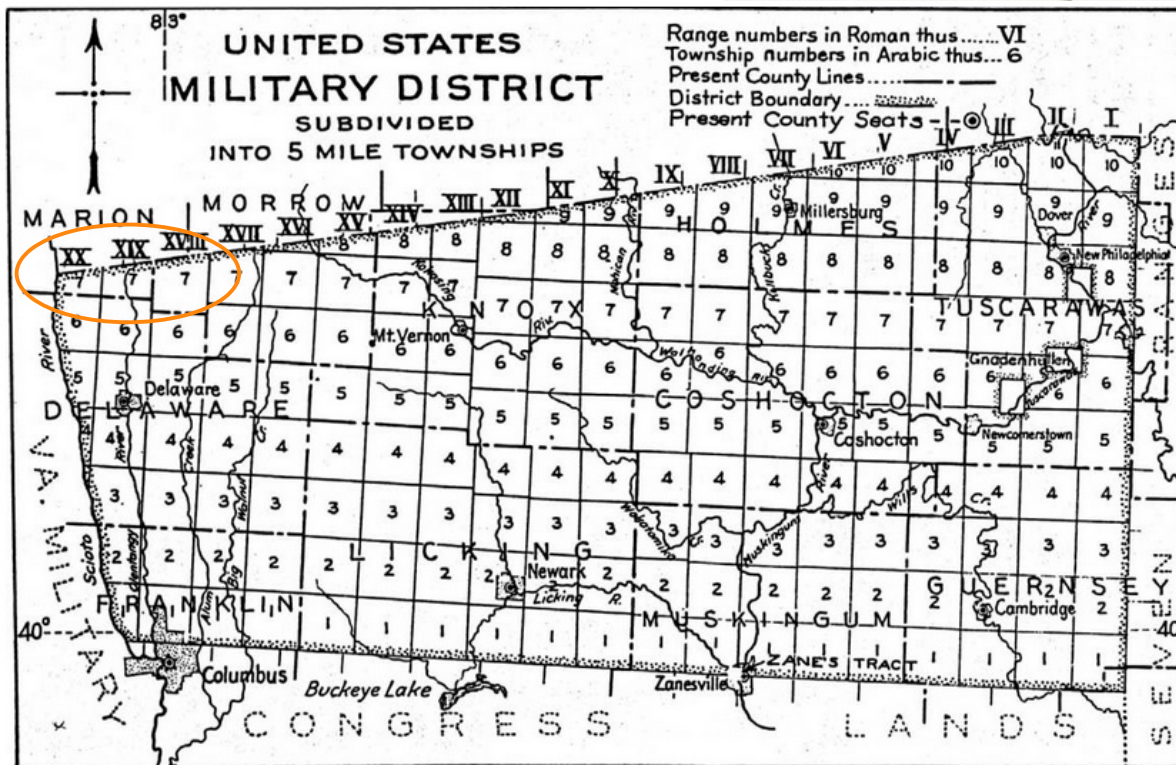

# John & Catherine Snyder - Clues

Another visualization of the area comes from the BLM. See

<https://glorerecords.blm.gov/LandCatalog/Catalog>

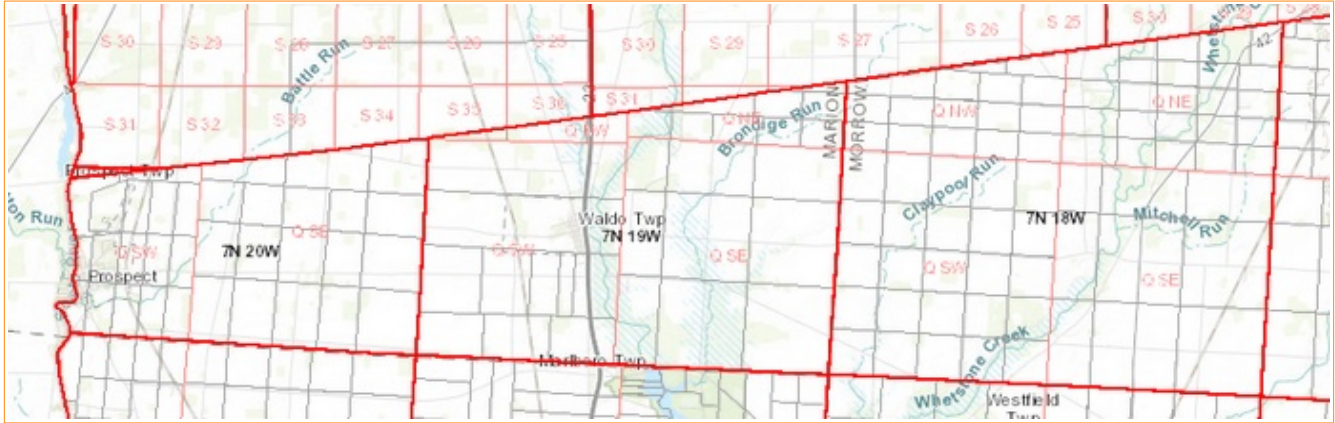

And, an 1878 map for Marion Co. shows the area as follows. See <https://www.ohiohistory.org/wp-content/uploads/2022/01/Harrison- Sutton- and Hare-s Atlas of Marion County 1878.pdf>. You can see that north of the US Military district “wedge” lie the townships in the first prime meridian.



See the next (BLM) section. (Snyder)

See the next (Marion) section. (Selanders)

See the next (Marion) section. (Culp)

# John & Catherine Snyder - Clues

## BLM Records

So, with this understanding of the area, what land/deed records exist that pertain to the Snyder family or their neighbors (particularly the Culp and Selanders families) in the 1850 census? First to BLM records. -

I searched the BLM general land office records for people with the Snyder surname in Marion Co. and found the following patent from 1832. It is for a quarter section in Pleasant Twp about midway between the village of Waldo and the city of Marion, held with in common with Henry Snyder. Its location is indicated in the map immediately above. See [https://glorerecords.blm.gov/details/patent/default.aspx?accession=OH0810\\_\\_466&docClass=STA&sid=3pm0scmt.fry](https://glorerecords.blm.gov/details/patent/default.aspx?accession=OH0810__466&docClass=STA&sid=3pm0scmt.fry) .

Land Patent Details						
Accession Nr: OH0810__466 Document Type: State Volume Patent State: Ohio Issue Date: 6/1/1832 Cancelled: No						
Names On Document			Miscellaneous Information			
<input type="checkbox"/> SNYDER, HENRY, <input type="checkbox"/> SNYDER, JOHN			Land Office:	Tiffin		
			US Reservations:	No		
			Mineral Reservations:	No		
			Tribe:	---		
			Militia:	---		
			State In Favor Of:	---		
Military Rank: ---			Authority:	April 24, 1820: Sale-Cash Entry (3 Stat. 566)		
Document Numbers			Survey Information			
Document Nr:	4832		Total Acres:	160.00		
Misc. Doc. Nr:	---		Survey Date:	---		
BLM Serial Nr:	OH NO 5/N		Geographic Name:	---		
Indian Allot. Nr:	---		Metes/Bounds:	No		
Land Descriptions						
State	Meridian	Twp - Rng	Aliquots	Section	Survey #	County
OH	1st PM	006S - 015E	NE¼	15		Marion

The only Henry Snyder that I can find at familyserach.org is a person in his thirties at the time of the 1840 census, and this person may have died in 1841. This person was enumerated in Marion Twp, however. He and his wife and their three young children were living near a much older John Wolfe and another young family of Henry Wolfe. There is a Jonathan Snyder in the same township in the 1840 census, who perhaps is Henry's "partner," but this is speculation.

A similar search of patents in Delaware county for anyone with the Snyder surname returned an empty set. Searches for the names Selanders and Culp in both Marion and Delaware counties were fruitless as well.

# John & Catherine Snyder - Clues

## County Records

County deed records exist at [familyserach.org](http://familyserach.org). They even have some indexes, but there are many entries. I have conducted some searches in Marion County records for Synder, Culp, and Selanders people to see if I can find examples where property ownership was transferred from them to someone else between about 1850 and 1870. Then, since grantee indexes exist for Delaware Co., I looked for situations in which one of the surnames of interest appeared as a grantee before about 1850. This approach is based on an assumption that land was acquired in the vicinity of Waldo before the county boundary shifted (when the Waldo area was in Delaware Co.) and then sold after the boundary shift in 1848.

Details follow, but a summary is that there are property transactions for Selanders and Culp family members in the U.S. Military District lands areas just east of the village of Waldo as well as slightly south to the village of Norton. I never found a property transaction that seemed to apply to the family of Catherine and John Snyder. Perhaps they were too poor to have purchased land and that is why he is listed as a laborer in the 1850 census.



# John & Catherine Snyder - Clues

## Marion County Search

Here are things that I have found in the "S" index. (See <https://www.familysearch.org/ark:/61903/3:1:3QS7-8937-5KSK?i=8&cat=252960> )

## Selanders Transactions

In image 11, there is a transaction in which Anna Selanders obtains land from the county auditor on 4/18/1871. (This is after the death of husband William in 1862.) The property is section 3 of twp 7 rng 19. This property is not too far NE of the village of Waldo.



The transaction is shown in image 396 of <https://www.familysearch.org/ark:/61903/3:1:3QS7-8937-5R4K?i=395&cat=252960> . Part of the image follows.

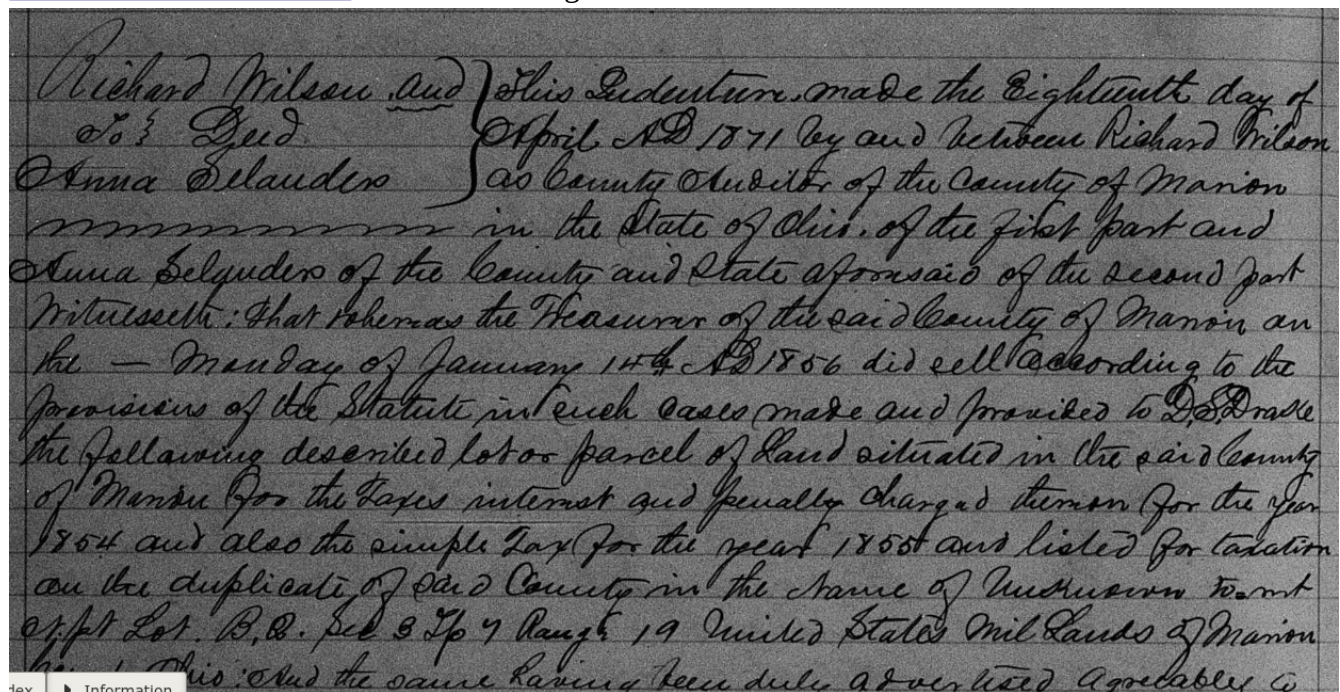

dex | Information

## John & Catherine Snyder - Clues

In image 10 of the index, there is an earlier transaction in which land (10 acres) in the same section is deeded to Anna Selanders by Jacob Coleman and wife Elvina. The date is 12/7/1862, and this is probably after the death of husband William. This 20 acre parcel is in the U.S. Military Reserve.



The actual deed can be found in image 656 of <https://www.familysearch.org/ark:/61903/3:1:3Q57-L937-GQHW?i=655&cat=252960> . A copy follows.

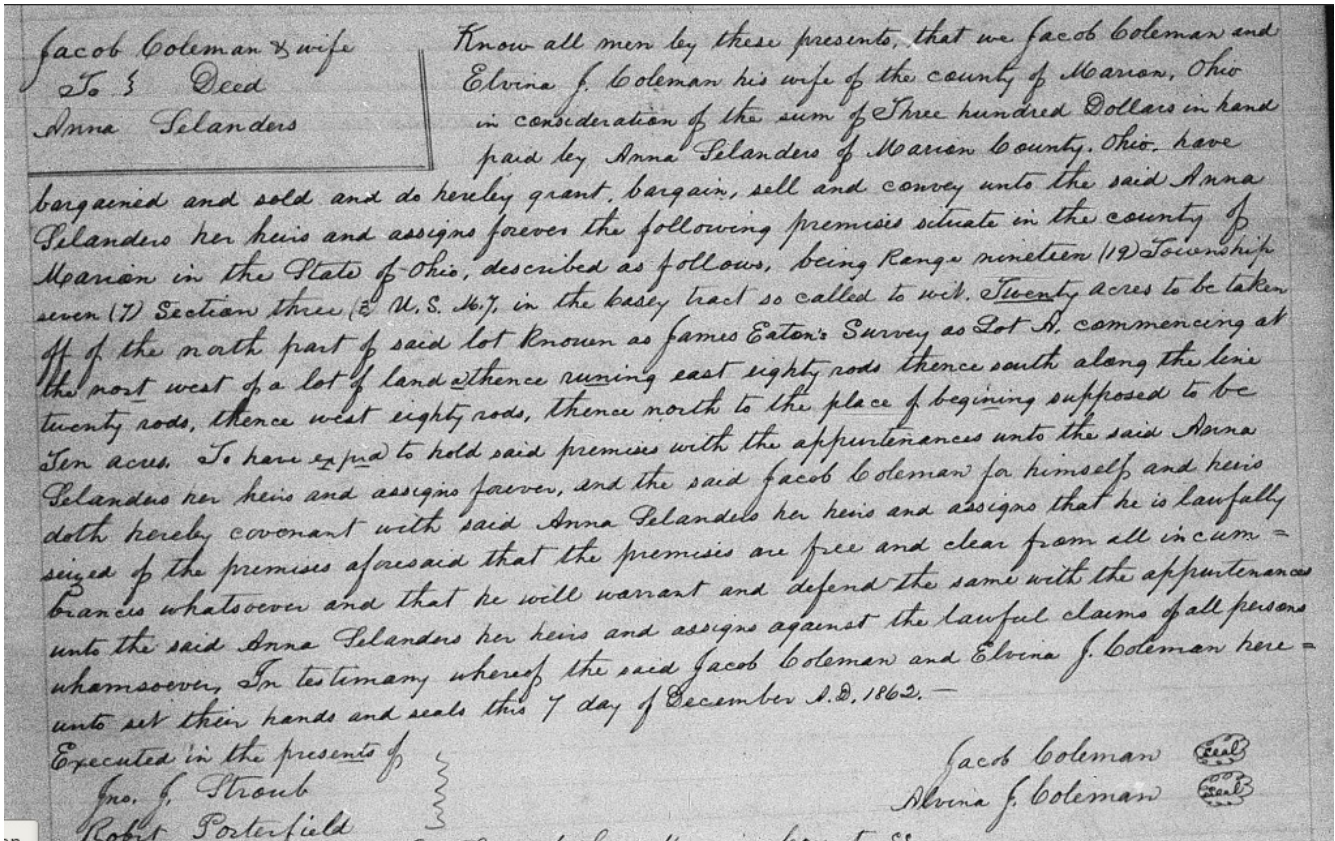

### Snyder Transactions

None were found that appeared interesting – names, dates, locations too far from geographic area of interest.

# John & Catherine Snyder - Clues

## Culp Transactions

Image 10 of <https://www.familysearch.org/ark:/61903/3:1:3QS7-L93H-CRQF?i=9&cat=252960> shows a number of transactions involving Andrew S. Culp, the son of the Andrew who is the brother of Simon Culp. These transactions (purchases) are in the 1880s involving land in section 19 of twp 7 rng 19, which is just a short distance east of the village of Waldo in the U.S. Military District. (The property descriptions are amusing, being metes and bounds using poles and links and perches for distances relative to things like rocks!)

Image 9 of the same reference given above shows a few more transaction involving Andrew S. Culp and land east of Waldo. In addition, however, there are two transactions involving Andrew Culp (the father). These involve land in twp 7 rng 19 in the 1860s. An example is a transaction from 11/24/1869 involving Henry Strine. Andrew's wife Leah signs the deed, so the identity of Andrew as the father is proven. See image 533 of <https://www.familysearch.org/ark:/61903/3:1:3QS7-893H-7DF2?i=532&cat=252960>.

## John & Catherine Snyder - Clues

Image 8 shows another transaction involving Andrew Culp. This transaction also involves land in section 12 of twp 7 rng 19 (40 acres). The date is 3/21/1857, and it involves Adam Pfirsch. Andrew (of Franklin Co., PA) is buying 40 acres (partly bounded by land owned by Henry Strine. Perhaps this takes place are Andrew moves from PA to OH. See image 190 of <https://www.familysearch.org/ark:/61903/3:1:3Q57-L937-P71?cat=252960>. BTW, the deed is witnessed by William Selanders.

<p>1300 12-7-19 40</p>	<p>Adam Pfirsch &amp; Wife to Dud Andrew Culp</p>	<p>Know all men by these presents that we Andrew Pfirsch and Cath- arine Pfirsch wife of the said Adam Pfirsch of the County of Mari- on and State of Ohio in consideration of the sum of thirteen Hundred Dollars in hand paid by Andrew Culp of the County of Franklin and State of Pennsylvania, have bargained and sold and do hereby grant, bar- gain, sell and convey unto the said Andrew Culp his heirs and assigns forever the following premises, Situate in Walde Township, Marion County and State of Ohio, and bounded and described as follows, being the South East quarter of Section twelve (12) Township seven (7) Range nineteen (19) N. S. E. bounded on the East by land owned by John Justice, on the West by land owned by Henry Strine, on the North by William and John Justice, on the South by land owned by Martin Roger, containing forty Acres in the South West corner of said Lot of Land be the same more or less. To have and to hold said premises with the appurtenances unto the said Andrew Culp his heirs and assigns forever, and the said Adam Pfirsch for himself and heirs doth hereby covenant with said Andrew Culp his heirs and assigns that he is lawfully seized of the premises aforesaid that the premises are free and clear from all incumbrances whatsoever, and that he will forever warrant and defend the same with the appurtenances, unto the said Andrew Culp his heirs and assigns, against the lawful claims of all persons whatsoever. In testimony whereof the said Adam Pfirsch and Catharine Pfirsch his wife have hereunto set their hands and seals this 21<sup>st</sup> day of March in the year 1857.</p>
	<p>Witnessed in presence of Wm Selanders John Fortfield</p>	<p>Adam Pfirsch      (Seal) Catherine Pfirsch      (Seal)</p>

# John & Catherine Snyder - Clues

## Delaware County Search

Delaware records include indexes organized both by grantors and grantees. Here are the results of searches of the indexes for the period 1830-1850 (roughly).

## Selanders Transactions

None found.

## Snyder Transactions

None found.

## Culp Transactions

There are many, starting in 1860. Many appear to involve Ellen and Simon Culp in Norton & Radnor townships. Then there are some associated with other Culp in Norton and Scioto townships. See image 102 of <https://www.familysearch.org/ark:/61903/3:1:3Q9M-CSQK-T9TF-L?i=101&cat=708221>.

GRANTOR INDEX TO DEEDS — Delaware County, Ohio														79			
DATE FILED			GRANTORS			A P	GRANTEES			A P	DEED RECORD		TOWN OR TOWNSHIP				REMARKS
No.	Day	Yr.	SURNAME	GIVEN NAMES ABCDEFGHIJKL	GIVEN NAMES LMNOPQRSTUVWXYZ		Vol.	Page	R.		Tp.	Sec.	Lot	V. M. Survey	In Lot	Out Lot	
4	23	60	Culp	Ellen	Simon	Peter Loeffel	45	59	Norton					48	58	4 Lts	
6	15	61	do	Ellen	Simon	William Powell	46	330								3 A	
6	15	61	do	Ellen	Simon	Joseph Powell	0	46	332	Radnor	20	6	1	21			
6	6	64	do	Ellen	Simon	William W Glaze	50	484	Norton					57	56		
12	8	65	do	Eleanor	Simon	Peter Schultz	53	530	Norton					70	48	4 Lts	
5	14	66	do	Ellen	Simon	Charles High Sr	54	532	Norton					57	60	9 Lts	
11	25	69	do	Andrew S	Mary J	Rachel Bennett	61	122	Norton					48	70	4 Lts	
10	3	73	do		Maria Samuel	Thomas Jones	65	494	Scioto				5868				
3	25	79	do	Andrew	Sarah	William H Perkins	72	511					5499				
12	16	80	do	Andrew	Sarah	Charles F Burner	12	610					5447			3 Sur	
12	16	80	do	Andrew	Sarah	do	76	124					5869			3 Trs	
													5447				
													5449				

Note: Lists like this can also be generated using a tool from the Delaware County Recorder's Office. See <https://cotthosting.com/ohdelaware/HTML5Viewer/ImageViewer.aspx?OIB=true>. Select grantor or grantee, enter a surname, press "search." For example, some Culp as grantees . . .

No.	Day	Yr.	GRANTOR SURNAME	GRANTOR GIVEN NAMES	GRANTEE SURNAME	GRANTEE GIVEN NAMES	Vol.	Page	Town or Township	R.	Tp.	Sec.	Lot	V. M. Survey	In Lot	Out Lot	REMARKS
9	10	57	Culp		Simon	Henry Brown	0	41	339	Radnor	20	6	1	21			By Gdn
1	4	58	Custard	Anthony		Caleb Hill Jr	41	527	Thompson					1930			
4	5	60	Culp		Simon	Joseph Bottenfield	0	44	611	Radnor	20	6	1	20			
4	5	60	do		Simon	Jane King	44	612	Norton					48	82		12 Lts
6	15	61	do		Simon	William Osborn	W	46	328								3A
6	15	61	do		Simon	Henry Worline	W	46	328	Radnor	20	5	1	21			
6	15	61	do		Simon	J N Brown	0	46	330	Radnor	20	6	1	21			
3	29	64	Curtain	John		Lewis H Lee	W	50	164	E Del-L, H & Grace V Lee Add						1217	
1	31	65	Cushman		Mariah	Isaac Curren	W	51	590		20	6	1	28			
3	27	66	Culp		Simon	Peter Loeffel	W	54	289	Del				48	78		4 Lts
4	5	66	do		Simon II	Pete Schultz	54	356	Norton					48			

# John & Catherine Snyder - Clues

4/23/1860 transaction: sale of lots in the village of Norton -

Simon Culp }  
 Deed to }  
 Peter Loeffel }  
 Know all men by these presents that we  
 Simon Culp and Ellen Culp of the County  
 of Delaware this in consideration of the sum  
 of eight, four dollars and fifty Cents in hand  
 paid by Peter Loeffel of the same place have bargained & sold  
 and do hereby bargain sell and convey unto the said Peter  
 Loeffel his heirs and assigns forever the following premises  
 Situate in the County of Delaware in the state of Ohio and  
 in the town of Norton and bounded and described as  
 follows being the east half of In Lots Nos 48-58-59 & 70 as

designated on the plat of said town, being the same prem-  
 ises deced by sd Wm. Green to John King and killed by said  
 John King deceased to his wife Jane King and deced by  
 said Jane King to Simon Culp. To have and to hold  
 said premises with the appurtenances unto said Peter Loeffel  
 his heirs and assigns forever, and that said Simon Culp  
 for himself and heirs doth hereby covenant with the  
 said Peter Loeffel his heirs and assigns, that he is lawfully  
 seized of the premises aforesaid that the premises are free  
 and clear from all incumbrances whatsoever and that  
 he will forever warrant and defend the same with the  
 appurtenances unto the said Peter Loeffel his heirs and  
 assigns against the lawful claims of all persons whomsoever.  
 In testimony whereof the said Simon Culp and Ellen  
 Culp have hereunto set their hands and seals this fourteenth  
 day of November in the year of our Lord one thousand eight  
 hundred and fifty nine.  
 Signed, Sealed & acknowledged  
 in presence of  
 S. W. Cleveland  
 Margaret Culp  
 Simon Culp (Seal)  
 Ellen Culp (Seal)  
 The State of Ohio Delaware County is,  
 before me S. W. Cleveland a Justice of the Peace in and  
 for said County personally appeared the above named Simon  
 Culp and Ellen Culp his wife and acknowledged the signing  
 and sealing of the above conveyance to be their voluntary act  
 and deed and the said Ellen being at the same time  
 unmarried by me separate and apart from her said  
 husband, and the contents of the above instrument made  
 known to her by me she then declared that she did voluntar-  
 ily sign seal and acknowledge the same, and that she is  
 still satisfied therewith, this 14<sup>th</sup> day of November 1859.  
 S. W. Cleveland J. P.  
 Recd. Apr 23<sup>rd</sup> 1860, and recorded May 10<sup>th</sup> 1860 -  
 R. R. Gould Recorder

## John & Catherine Snyder - Clues

Transactions on 6/15/1861: The first is the purchase of land by Simon Culp. (west ½ of lot 21, section 1, twp 6 north rng 20 west in Radnor Twp) This is quite close to the village of Norton. See image 817 of <https://www.familysearch.org/ark:/61903/3:1:3Q9M-CSTC-VSTX?i=816&cat=708221> .

William Brown ) Know all men by these presents that we  
 and others ) William Brown & Lucetta his wife & James  
 and to ) N Brown & Sarah his wife & Martha Brown  
 Simon Culp ) in consideration of the sum of seventy five Dollars  
 paid by Simon Culp here and do hereby bargain  
 sell release and quit-claim unto said Simon Culp  
 and unto his heirs and assigns forever all their right title and estate  
 in the following premises in Radnor township Delaware County  
 Ohio to wit: situated in the south east corner of the west half  
 of Lot No 21 Section 1 Township 6 range 20 N, E. M. Survey in  
 Radnor Township in Delaware County containing one acre and  
 fourtenths purchase of land with a steen sawmill thereon  
 which land is held by lease given by Isaac Curren to James  
 Brown & Co. As long as used for Mill purposes, & the said Simon  
 Culp is, to have and to hold all their right and title and estate  
 legal and equitable in said premises unto their appointances  
 unto said Simon Culp his heirs and assigns forever  
 In witness whereof the said above Grantors both hereunto set  
 their hand and seal this twelfth day of June Anno Domini eighteen  
 hundred and fifty eight  
 Signed sealed and acknowledged  
 in presence of us,  
 Isaac Curren  
 Hudson Spalding

William Brown *(S)*  
 Lucetta M Brown *(S)*  
 J. N. Brown *(S)*  
 Sarah Brown *(S)*  
 Martha Brown *(S)*

The State of Ohio Delaware County ss.  
 Personally came before me Isaac Curren a Justice of the peace in and for said  
 County the signers and sealers of the above instrument and acknowledged the same  
 to be their voluntary act deed for the purposes therein expressed:  
 Intestimony whereof I have hereunto subscribed my name and  
 affixed my seal official on this day and year above written  
 Isaac Curren J. P.  
 Received for record June 16 1861, and recorded July 3<sup>rd</sup> 1861  
 A. R. Gould Recorder P. O.

## John & Catherine Snyder - Clues

The second transaction on this date starts at the bottom of the same page. It is the sale of property – the site of a mill in lot 21, section 1, twp 6, rng 20.

Simon Culp }  
 deed to }  
 Wm Powell }  
 Know all men by these presents, that we Simon Culp and Eleanor Culp wife of said Simon Culp of the County of Delaware Ohio, in consideration of the sum of Five hundred dollars in hand paid by William Powell of the

Simon Culp }  
 deed to }  
 Wm Powell & }  
 Joseph Powell }  
 Know all men by these presents that we Simon Culp and Ellen Culp wife of said Simon Culp of the County of Delaware Ohio in consideration of the sum of one thousand two hundred dollars in hand paid by William Powell & Joseph Powell of the same place, have bargained and sold and do hereby grant and convey unto the said William Powell & Joseph Powell their heirs and assigns forever the following premises situate in the Township of Radnor in the County of Delaware in the State of Ohio, Bounded and described as follows, in the South East corner of the west half of Lot No twenty one (21) Section one (1) Township six (6) Range twenty (20). Being the equal undivided  $\frac{1}{4}$  of one acre and fourteen rods of land with a Steam Saw Mill built thereon, Being the premises leased to J. S. Brown and Co. as long as it shall be occupied for mill privileges. To have and to hold all the said Simon Culp's right title and estate legal and equitable in said premises with the appurtenances unto said William Powell & Joseph Powell their heirs and assigns forever.  
 In testimony whereof the above named Simon Culp and Ellen Culp have hereunto set their hands and seals this third day of May in the year eighteen hundred and sixty one  
 Signed, Sealed & acknowledged }  
 in presence of }  
 Maggie Culp }  
 S. W. Cleveland }



## John & Catherine Snyder - Clues

The 6/6/1864 transaction is the sale of property to William Glaze (son in-law) in the village of Norton – parts of lots 56 & 57.

Simon Culp & wife }  
deed to }  
William W. Glaze }  
Know all men by these presents, that we Simon Culp, and Ellen Culp wife of the said Simon Culp of the County of Delaware Ohio, in consideration of the sum of twenty five dollars in hand paid by William W. Glaze of the same place, have bargained and sold, and do hereby grant and convey unto the said William W. Glaze his heirs and assigns forever, the following premises, situate in the Town of Norton in Delaware County and in the State of Ohio and bounded and described as follows. Beginning at the north west corner of Lot No 56, thence east to the north east corner of said lot 56, thence south on the east line of aforesaid Lot No 56, six feet to a stake thence east parallel with the line of Lot No 57 to the east line of said Lot 57, thence south forty four feet to a stake, thence west to the west line of Lot No 56, thence north fifty feet to the place of beginning: To have and to hold said premises with the appurtenances unto the said William W. Glaze his heirs and assigns forever, and the said Simon Culp for himself and heirs doth hereby covenant with the said William W. Glaze his heirs and assigns, that he is lawfully seized of the premises aforesaid, and that the premises are free and clear from all incumbrances whatsoever, and that he will forever warrant and defend the same with the appurtenances unto the said William W. Glaze his heirs and assigns against the lawful claims of all persons whomsoever. In testimony whereof

continued . . .

## John & Catherine Snyder - Clues

the said Simon Culp and Ellen Culp have hereunto set their hands  
and seals this twenty ninth day of April in the year of our Lord  
one thousand eight hundred and sixty four.

Signed, sealed & acknowledged  
in presence of S. H. Cleaveland  
James M. Coldren

Simon Culp (Seal)  
Ellen Culp (Seal)

The State of Ohio Delaware County ss.  
Before me S. H. Cleaveland a Justice of the Peace in and for said  
County personally appeared the within named Simon Culp  
and Ellen his wife, and acknowledged the signing and  
sealing the within conveyance to be their voluntary act and  
deed, and the said Ellen being at the same time examined  
by me separate and apart from her husband, and the contents  
of said instrument made known to her by me, she then de-  
clared that she did voluntarily sign seal and acknowledge the same  
and that she is still satisfied therewith, this 29<sup>th</sup> day of April  
A.D. 1864. S. H. Cleaveland J.P.

Recd. June 6, 1864, and recorded July 14, 1864.  
A. P. Gould Recorder

Transactions dated 12/8/1865 and 5/14/1866 are for the sale of additional lots in the village of Norton. See image 270 of <https://www.familysearch.org/ark:/61903/3:1:3Q9M-CSTC-LHZL?i=269&cat=708221> as well as image 596 of <https://www.familysearch.org/ark:/61903/3:1:3Q9M-CSTC-L468?i=595&cat=708221> .

## John & Catherine Snyder - Clues

For reference, the village of Norton is just a short distance south of the village of Waldo (~2 miles). See the map that follows. (<https://www.loc.gov/resource/g4083d.la000617/?r=0.356,0.158,0.135,0.081,0>)



# John & Catherine Snyder - Clues

An image from an 1866 atlas shows Norton in more detail. Reference a Union Co. site as follows! Access the 1866 atlas here <https://www.unioncountyohio.gov/atlas-es-county-plat-maps> . On image 17 of the atlas (page 14 in the atlas), find an image of the village of Norton and lots 56 & 57 and the structure associated with W. Glaze. Note that P. Glaze runs the thrasher.

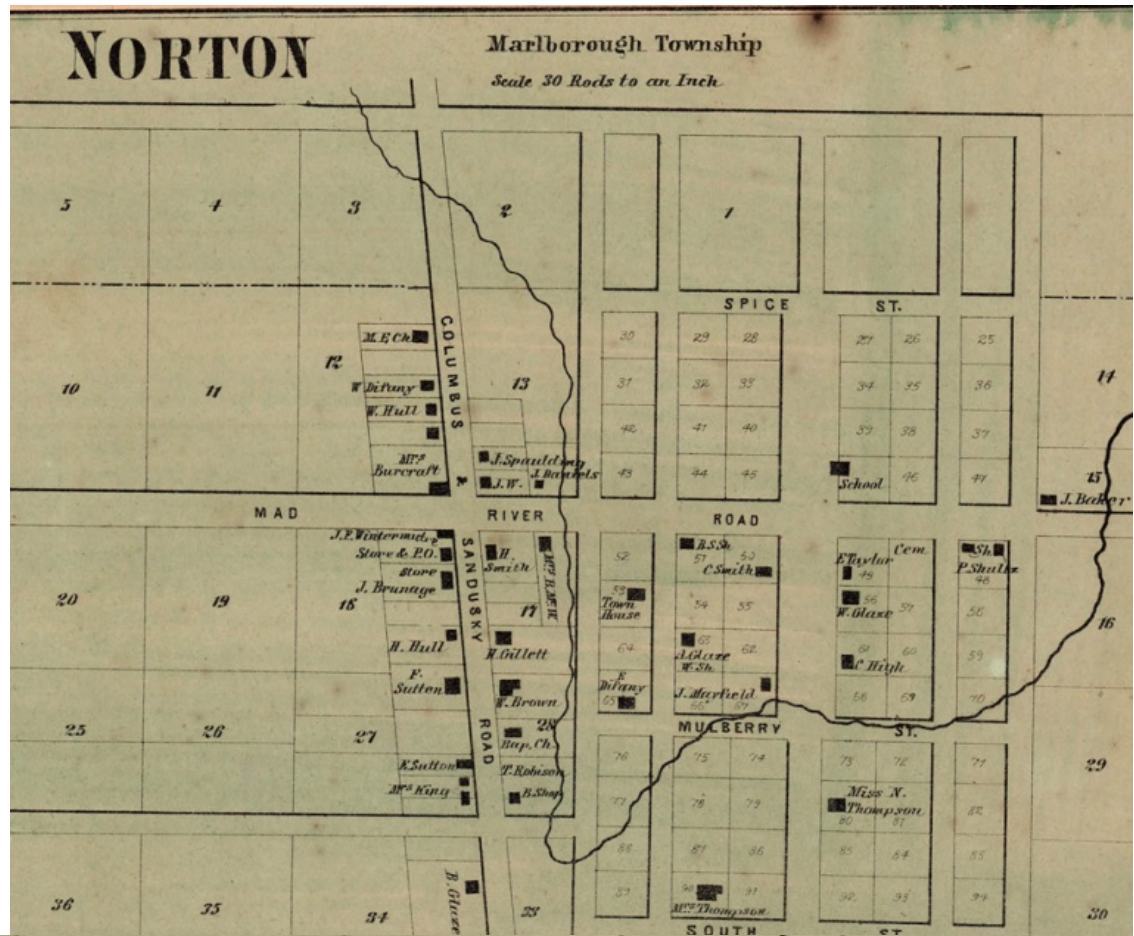

**NORTON ADVERTISING DIRECTORY**  
*J. F. Wintermute Dealer in Dry Goods Groceries &c.*  
*Tho<sup>s</sup> Robinson Blacksmith*  
*P. Glaze Prop<sup>r</sup> of Trashing Machine*

Pretty clearly Simon and Eleanor (Selanders) Culp were tied into people in the community of Norton, including the brothers William Glaze (1829-1914) and Benjamin Glaze (1833-1890), who married Simon and Eleanor's daughter Caroline Culp. Children inter-married and land was exchanged. No sign of Snyder folks, however.

# John & Catherine Snyder - Clues

## 1835 Male Residents

There is a reference text from the Delaware Co. Historical Society that shows male inhabitants of Delaware Co. in 1835. Searching for Culp, Snyder, Selanders, and Glaze yielded the following list. Other than names, no other information is provided.

William Glaze  
Samuel Snider  
George Snider  
Jacob Snider

William Glaze is already known from evidence presented above. It is not clear if the three Snider men are related to the John Snyder about whom I am seeking information. Superficially they do not seem to be related. See <https://delawareohio.pastperfectonline.com/library/8A33BABE-A07F-464A-B778-231807124575> and [http://ppolinks.com/delawareohio/fic2020\\_4\\_1\\_male\\_inhabitants.pdf](http://ppolinks.com/delawareohio/fic2020_4_1_male_inhabitants.pdf).

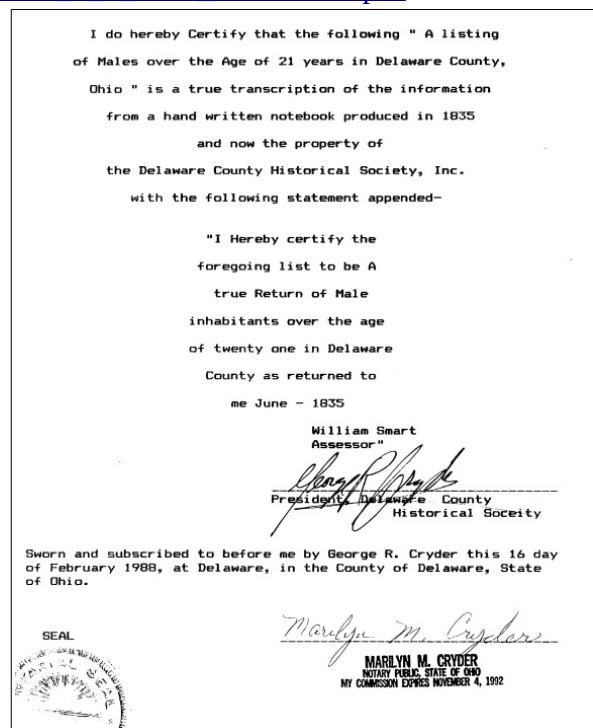
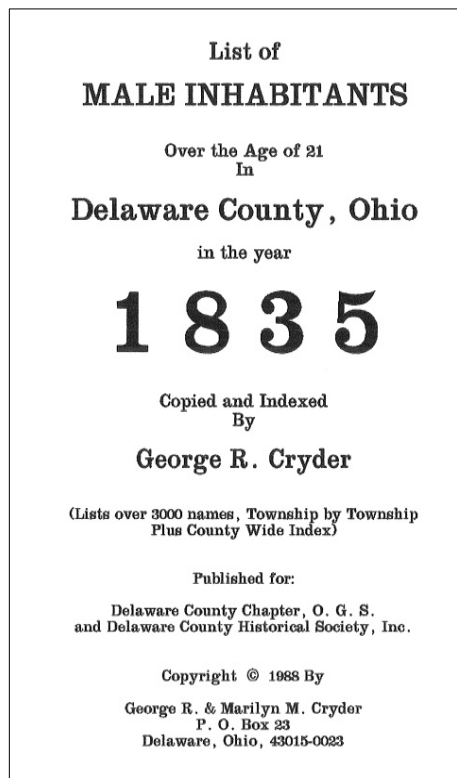

# John & Catherine Snyder - Clues

## US Military District Bounty Lands

It is possible that a Culp, Selanders, or Snyder person was originally granted bounty land for service in the Revolutionary War. The US Military District in OH is a possible suspect place based on the presence of these people in or near the district around 1850. Perhaps they acquired bounty land in the 1830s from someone else. I have not delved into sources about this land, except to identify where a person might look. Genealogical sources pertinent to the military district can be found at familysearch.org - [https://www.familysearch.org/en/wiki/United\\_States\\_Military\\_District\\_Genealogy](https://www.familysearch.org/en/wiki/United_States_Military_District_Genealogy) .

The US National Archives has some early bounty land information for the Military District. See <https://catalog.archives.gov/id/567388> .

Familysearch.org has images from a register of land warrants for the Military District of Ohio as follows: <https://www.familysearch.org/search/catalog/249409?availability=Family+History+Library> .

On the single roll of this microcopy is reproduced a register of bounty-land warrants, 1799-1805, which were surrendered for land in the Military District of Ohio. Under the Military Bounty Land Acts of July 9, 1788 (Journals of the Continental Congress, v. 34, p. 307, 308), and of March 3, 1803 (2 Stat. 236), the Federal Government granted public land to veterans and heirs of veterans of the Revolutionary War. Under an act of June 1, 1796 (1 Stat. 490), a U.S. Military District in Ohio was reserved solely for the use of these warrants.

After a veteran's application had been approved, he was issued a warrant entitling him to "locate" a specified number of acres on the public domain. He could himself present the warrant at a district land office and ask that a patent be issued for a particular tract; he could sell the warrant to someone else who might use it to obtain title to land; or under the scrips act warrants could be exchanged for land scrip, which in turn could be used to pay for public land.

The entries in the register are arranged chronologically. Each entry shows the name of the person who presented the warrant and therefore received a patent for the land, the name of the person who originally received the warrant for military service, his rank, and a legal description of the land in terms of lot, quarter section, township, and range. Most of the warrants were surrendered in groups of 4,000 acres by individuals who bought warrants from veterans or their heirs.

There are 311 images to be investigated here, and I have not done that work.

## John & Catherine Snyder - Clues

And then there is this reference as well. - <https://www.familysearch.org/search/catalog/267780?availability=Family+History+Library> . It includes important information about how the land warrants were issued. See image 8 of film 008423360 - <https://www.familysearch.org/ark:/61903/3:1:3Q9M-CS1K-FQRR?i=7&cat=267780> .

Originally the lands in the U.S. Military District of Ohio were to be distributed by January 1, 1800. By the end of 1802 about 14,000 warrants had been issued for 1,612,605 acres, of which 552,605 acres had not been located. To provide additional time to locate warrants, and also to grant warrants to soldiers who had made late applications or had not completed their claims, Congress passed the act of March 3, 1803, which was amended by the act of April 15, 1806. After 1806 Congress periodically extended the time limit necessary for registering and locating the warrants.

Until 1830 all U.S. Revolutionary War bounty land warrants, as distinct from Revolutionary War bounty land warrants issued by the States or through special acts of Congress, could be used to locate land only in the U.S. Military District of Ohio. By an act of May 30, 1830 (4 Stat. 423), scrip certificates were issued in exchange for unused warrants and could be used to purchase land in Ohio, Indiana, and Illinois. By an act of July 27, 1842 (5 Stat. 497), the scrip was honored for any land open in the public domain.

The warrants and related papers reproduced in this publication are arranged by date of act and thereunder in numerical sequence. The first series includes U.S. military bounty land warrants issued under the act of July 9, 1788, which are numbered 1-14220.

There are many images here to be reviewed, and I have not done the work.

## John & Catherine Snyder - Clues

The Ohio Genealogical Society also has a reference that lists some early land records for the US Military District. See

[https://ohiogensoc.mlasolutions.com/m5/catalog/\(S\(ijsy14g5uuhsivwowcmbt1t\)\)/Default.aspx?internal=1&installation=Default](https://ohiogensoc.mlasolutions.com/m5/catalog/(S(ijsy14g5uuhsivwowcmbt1t))/Default.aspx?internal=1&installation=Default) . I requested a “copy service request” form to see if there are entries for Culp or Snyder. The result was null for Culp, but three Snyder entries surfaced: one for a Henry Snider in Ross Co. consisting of 2 tracts of a total of 167 acres dated around 1800; one for Philip Snyder (!) in Scioto Co. consisting of 400 acres dated in 1800; one for J. Snyder consisting of the NE quarter of section 8 of Twp 3 Rng 14 (about 162 acres in Licking Co.(?)) dated Jan, 1828. None of these three appear relevant to the current search.

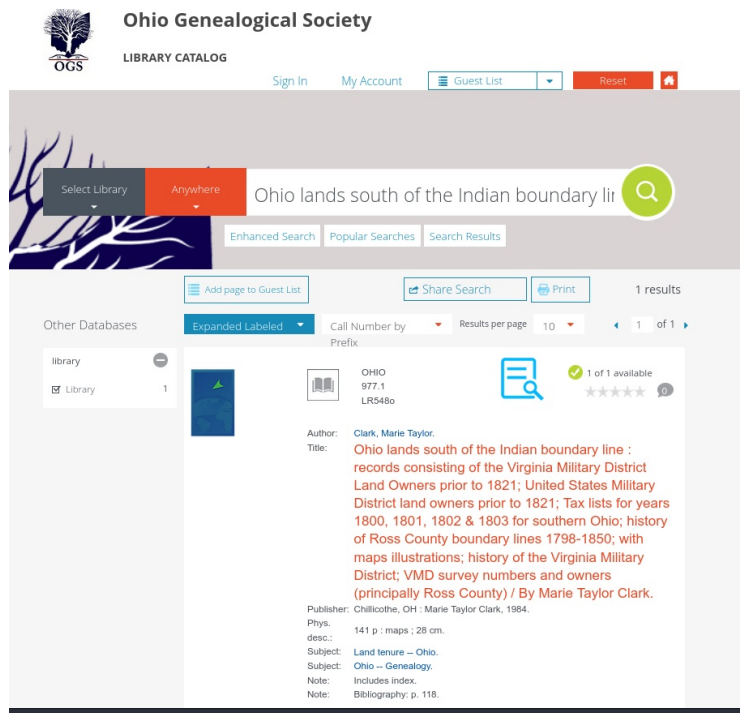

A search of <http://catalog.wrhs.org/collections/search> (Western Reserve Historical Society) turned up no new sources.

I contacted the CT State Library regarding “Connecticut State Library Stacks KF5675.A73 S6 ; Federal land series; a calendar of archival materials on the land patents issued by the United States Government, with subject, tract, and name indexes.

Smith, Clifford Neal.

Chicago, American Library Association 1972-<1986 >” to see if vol. 2 can be borrowed via inter-library loan.



# John & Catherine Snyder - Clues

## PA Hints

Looking for John Snyder and his wife Catherine with few clues may be a fool's errand. In the 1700s there were probably hundreds or thousands of people with the Snyder surname name, and the same can certainly be said of their given names. There is even one governor named Snyder from 1807-1817, and there is a county named Snyder, although it was not carved out from Union Co. until 1855.

Cumberland County is a natural place to start to look because of the evidence associated with the Selanders and Culp families that were neighbors to the Snyder family in OH in 1850. The following sections are an attempt to discover some possibly relevant information based on hints from perviously named sources that provide rough birth dates.

## Birth in Cumberland County?

There is the following baptismal record that caught my eye because of the date, the location, and the given name information. See "Pennsylvania Births and Christenings, 1709-1950", database, *FamilySearch* (<https://familysearch.org/ark:/61903/1:1:V2NP-3HV> : 15 February 2020), Johan Jacob Snyder, 1804.

Name: Johan Jacob Snyder

Sex: Male

Birth Date: 7 Jan 1804 [[Compare to 1850 census](#)]

Father's Name: Phillip Snyder

Father's Sex: Male

Event Type: Christening

Event Date: 29 Apr 1804

Event Place: New Kingstown, Cumberland, Pennsylvania, United States [[See later section "Geographically Based Summary."](#)]

Event Place (Original): Saint Stephen Evangelical Lutheran Church, New Kingstown, Cumberland, Pennsylvania, United States

Household	Role	Sex	Age	Birthplace
Phillip Snyder	Father	M		

Reference: Item 4

Digital Folder Number: 007717809

Microfilm Number: 496447

Originating System: ODM

Indexing Batch: C50482-1

If this record actually pertains to the John Snyder that I am seeking, then significant bits of information are (1) the location (New Kingstown) in Silver Spring Twp just to the northwest of Mechanicsburg, (2) the identity of a father named Phillip Snyder, (3) a specific Lutheran church, and (4) a specific birth date - 1/7/1804.

## John & Catherine Snyder - Clues

Examining the records for this church (St. Stephen's Evangelical Lutheran) in the book *Cumberland County Pennsylvania Church Records of the 18<sup>th</sup> Century* by F. Edward Wright, ISBN 978-0-7884-7691-4, pp. 65-70. led me to another intriguing family that included a first son Phillip, who may be the father named above. Here is a list if the births/baptisms for the family of Phillip Schneider and his wife Barbara (unknown surname).

- Phillip b.12/1774
- Johannes b. 6/1778
- Maria Magdalena b. 7/1784 (twin)
- Margaretha b. 9/1784 (twin)
- Anna Maria b. 9/1795
- Johannes b. 1/1797
- Elizabeth b. 10/1799
- Michael b.1801 (see below)

Witnesses along the way included these: Phillip Langsdorf, Susanna Emminger, Balthazar and Susanna Schneider, Wilhem Bohr, Maria Magdalena (?), Martin Langsdorf, Anna Margred, Johann Seiler and Anna Maria (Seiler?), George Bauer and Anna Maria (Bauer?). These associations may prove useful in future research. [Some of these names can be found in land tract information as well.]

The following reference for the same church yields the following list of Snyder/Schneider baptisms – reference = <https://www.familysearch.org/search/catalog/465669?availability=Family+History+Library>, images 108-161, pages 43-44 of the original document.

*SNYDER						
SCHNEIDER	BRN	DEC 1774	PHILLIPP	S*	PHILLIP SCHNEIDER AND BARBARA	00012-0
	CHR	JAN 1775				
SCHNEIDER	BRN	28 JUN 1778	JOHANNES	S*	PHILLIP SCHNEIDER AND BARBARA	00013-2
	CHR	JUL 1778				
SCHNEIDER	BRN	16 SEP 1784	MARGRETHA	D*	PHILLIP SCHNEIDER AND BARBARA	00015-6
	CHR	OCT 1784				

SCHNEIDER	BRN	16 SEP 1784	MARIA MAGDALENA	D*	PHILLIP SCHNEIDER AND BARBARA	00014-4
	CHR	OCT 1784				
SCHNEIDER	BRN	29 SEP 1795	ANNAMARIE	D*	PHILIP SCHNEIDER AND BARBARA	00080-6
	CHR	25 OCT 1795				
SCHNEIDER	BRN	22 FEB 1797	JOHANNES	S*	PHILIP SCHNEIDER AND BARBARA	00089-2
	CHR	7 MAY 1797				
SCHNEIDER	BRN	26 OCT 1799	ELISABETH	D*	PHILIP SCHNEIDER AND BARBARA	00113-6
	CHR	15 DEC 1799				
SCHNEIDER	BRN	17 APR 1801	JOHANNES	S*	JOHANNES SCHNEIDER AND A. MARIA	00135-5
	CHR	30 AUG 1801				
SCHNEIDER	BRN	24 NOV 1801	MICHAEL	S*	PHILIP SCHNEIDER AND BARBARA	00144-6
	CHR	21 MAR 1802				
SNYDER	BRN	7 JAN 1804	JOHAN JACOB	S*	PHILLIP SNYDER	00153-7
	CHR	29 APR 1804				

This adds one child (Michael) to the family above, and it shows the separate birth of Johann Jacob in 1804 as well as the birth of a Johannes in 1801, possibly to the second son of Phillip and Barbara.

## John & Catherine Snyder - Clues

Others have represented this family as shown in this tree -

<https://www.familysearch.org/tree/pedigree/landscape/L8X7-N3Y> .

The baptism for first son Phillip is recorded here as well. "Pennsylvania Births and Christenings, 1709-1950", database, *FamilySearch* (<https://familysearch.org/ark:/61903/1:1:V2NP-QND> : 15 February 2020), Phillip Schneider, 1775.

So, one line of investigation then might involve the proposal that Phillip (b.1774) is the father of the child Johann Jacob b. 1804 and noted above. This could be him in the 1800 census in Franklin Twp. - "United States Census, 1800," database with images, *FamilySearch* (<https://familysearch.org/ark:/61903/3:1:33S7-9R8K-9G4C?cc=1804228&wc=3V1X-CX6%3A1585149703%2C1585149702%2C1585149713> : 10 June 2015), Pennsylvania > Cumberland > Frankford > image 5 of 5; citing NARA microfilm publication M32, (Washington D.C.: National Archives and Records Administration, n.d.). Based on location (Frankford Twp) this may not be the same Phillip, however.

In what follows, I will focus on the name Phillip Snyder just to illustrate the kind of information that is available. Perhaps one day it turns out to be particularly relevant to my search for the origins of John and Catherine Snyder.

However, another less likely option to investigate is the family of Johannes Schneider (b. 1778). They appear to be having children in 1801. See the child named Johannes above born in 1801. Perhaps they had a son named John in about 1804.

## John & Catherine Snyder - Clues

### PA Direct Tax Lists 1798

Using the tax list information at ancestry.com (<https://www.ancestry.com/search/collections/2060/>) and searching for entries with the name Snyder in Cumberland County yielded the following list.

Name	County	Locality
Anthony Snider	Cumberland	
Anthony Snider	Cumberland	East Pennsborough
Balser Snider	Cumberland	Westpennsborough
Baltren Snider	Cumberland	Westpennsborough
Baltzer Snider	Cumberland	
Baltzer Snider	Cumberland	Westpennsborough
Christy Snider	Cumberland	Frankford
Christy Snider	Cumberland	Frankford
Christy Snider	Cumberland	Frankford
Christy Snider	Cumberland	Frankford
Conrad Snider	Cumberland	Allen
Conrad Snyder	Cumberland	
Conrad Snyder	Cumberland	
Conrad Snyder	Cumberland	Allen
David Snider	Cumberland	
David Snider	Cumberland	6th Division
David Snider	Cumberland	Mifflin
David Snider	Cumberland	Westpennsborough
David Snider	Cumberland	Westpennsborough
Geo Snider	Cumberland	Frankford
Geo Snider Junior	Cumberland	Frankford
George Snider	Cumberland	Carlisle
George Snider	Cumberland	Carlisle
George Snider	Cumberland	Frankford
George Snider	Cumberland	Frankford
George Snider	Cumberland	Frankford
George Snider Junior	Cumberland	Frankford
Henry Snider	Cumberland	Tyrone
Henry Snyder	Cumberland	
Henry Snyder	Cumberland	Allen
John Snyder	Cumberland	Shippenburg and South Hampton
Myer Snyder	Cumberland	Greenwood
Myers Snyder	Cumberland	Cumberland

## John & Catherine Snyder - Clues

Name	County	Locality
Nicholas Snider	Cumberland	Leboyne
Peter Snider	Cumberland	Tyrone
Philip Snider	Cumberland	(East Pennsboro)
Philip Snider	Cumberland	East Pennsborough
Philip Snider	Cumberland	East Pennsborough
Philip Snider	Cumberland	Frankford
Philip Snider	Cumberland	Frankford
Philip Snider	Cumberland	Tyrone
Phillip Snider	Cumberland	Frankford
Phillip Snider	Cumberland	Frankford
Snyder and Myer Snyder	Cumberland	Greenwood

A more compact view (pivot table) follows.

Name	(empty)	6th Divisi	Allen	Carisie	Cumberla	East Pen	Frankford	Greenwo	Leboyne	Mifflin	Shippen	Tyrone	Westpen	Total Result
Anthony Snider	1					1								2
Balser Snider													1	1
Baltren Snider													1	1
Baltzer Snider	1												1	2
Christy Snider							4							4
Conrad Snider			1											1
Conrad Snyder	2		1											3
David Snider	1	1								1			2	5
Geo Snider							1							1
Geo Snider Junior							1							1
George Snider				2			3							5
George Snider Junior							1							1
Henry Snider												1		1
Henry Snyder	1		1											2
John Snyder												1		1
Myer Snyder								1						1
Myers Snyder					1									1
Nicholas Snider										1				1
Peter Snider												1		1
Philip Snider	1					2	2					1		6
Phillip Snider							2							2
Snyder and Myer Snyder								1						1
<b>Total Result</b>	<b>7</b>	<b>1</b>	<b>3</b>	<b>2</b>	<b>1</b>	<b>3</b>	<b>14</b>	<b>2</b>	<b>1</b>	<b>1</b>	<b>1</b>	<b>1</b>	<b>3</b>	<b>44</b>

From this it is clear that there was a concentration of Snyder holdings in Frankford Twp with a secondary concentration in West Pennsboro, which could also be interpreted as being in roughly the same area. Possible family clusters could be centered on the following people: Balthazar Snyder, two people named Phillip Snyder, and a cluster around George Snyder. Perhaps the John Snyder that I am seeking information about is associated with one of these groups. See the map that follows in a later section for a spatial representation.

# John & Catherine Snyder - Clues

## East Pennsboro – Philip Snyder

Focusing just on Phillip Snyder taxable holdings as an example, here is the 1798 tax information provided. First for there is a description of a dwelling. There are lots of lights (230) in this dwelling! See <https://www.ancestry.com/discoveryui-content/view/326160:2060?tid=&pid=&queryId=540d2b28654c4e3479c5ff5b14f38343&phsrc=xly614&phstart=successSource>

*A List* or Description of each Dwelling-houfe, with the Out-houfes appurtenant thereto, and the Lot on which the fame are erected, not exceeding two Acres in any cafe, and exceeding in Value the Sum of One Hundred Dollars, which were owned, poffeffed, or occupied on the first day of October, 1798, in *East Pennsborough Township, Lumb. County* in the *3<sup>rd</sup> Settlement District, 6<sup>th</sup> Division* in the STATE OF PENNSYLVANIA.

Number of Returns.	NAME of the OCCUPANT.	NAME of the OWNER.	Dwelling Houfe.	Out-houfes appurtenant.	Dimensions or Area.	Materials of which built.	Number of Stoves.	Number of Windows.	Number of Lights.	Quantity of Land in each Lot.			Situation and adjoining PROPRIETORS.	Valuations of the affiance Affior.	Claims of Exemption (if any) and Circumstances thereof.
										Acres.	Perches.	Square feet.			
213	<i>Sively Jacob</i>		1	1	40 by 30	Wood	2	17	204	2	"	"	"	600	
214	<i>Silver Matthias</i>		1	1	26 " 22	"	2	11	109	2	"	"	"	500	
215	<i>Snyder Philip</i>		1		36 " 34	Stone	2	18	230	2	"	"	"	1000	

This appears to be another description of the dwelling. See <https://www.ancestry.com/discoveryui-content/view/325907:2060?tid=&pid=&queryId=540d2b28654c4e3479c5ff5b14f38343&phsrc=xly614&phstart=successSource>

214	<i>Snyder Matthias</i>	1	1	26 22	<i>Sq Log</i>	2	11	109			2			500	"	500	
215	<i>Snyder Philip</i>	1		36.34	<i>Stone</i>	2	18	230			2			1000	"	1000	

There is also a description of a 210 acre tract in East Pennsboro as follows. See <https://www.ancestry.com/discoveryui-content/view/326382:2060?tid=&pid=&queryId=540d2b28654c4e3479c5ff5b14f38343&phsrc=xly614&phstart=successSource>

170	<i>Snyder Philip</i>										210	"		<i>Philip Evers</i>	2310	
-----	----------------------	--	--	--	--	--	--	--	--	--	-----	---	--	---------------------	------	--

A safe conclusion is that in 1798, there is a Phillip Snyder living and farming in East Pennsboro in 1798 on 210 acres of land.

# John & Catherine Snyder - Clues

## Frankford – Phillip Snyder

Here are the entries for Snyder families. Based on the number of lights, the two major Snyder households belong to George Snyder and Phillip Snyder!

66	Shambaugh Geo	1	28 by 16	wood	1/2	4	29	2	"	"	"	166
67	Snyder Christy	1	24 by 22	ditto	2	3	36	2	"	"	"	187
68	Snyder George	1	35 by 20	ditto	2	12	18	2	"	"	"	268
69	Geo Snyder Junr	1	20 by 16	ditto	1/2	2	20	2	"	"	"	100 50
70	Shambaugh Chris	1	20 by 18	ditto	1/2	3	24	2	"	"	"	135
71	Leather Jacob	1	26 by 24	ditto	1/2	4	42	2	"	"	"	190
72	Shambaugh Philip	1	28 by 24	ditto	1/2	4	32	2	"	"	"	190
73	Sharp John	1	22 by 20	ditto	1/2	3	18	2	"	"	"	172
74	Snyder Philip	1	26 by 27	ditto	2	8	96	2	"	"	"	213

Here are the corresponding Snyder farms. George Snyder has the most valuable farm by far.

in any case, are above the Value of One Hundred Dollars.

Number of Returns.	NAME of the OCCUPANT.	NAME of the OWNER.	Number of Dwelling-Houses of a value not exceeding One Hundred Dollars.	Dimensions of Dwelling-Houses & Out-Houses.	Number and description of all other BUILDINGS.	Quantity of Land in each Lot.			Situation and adjoining PROPRIETORS.	Valuations of the estate Affdor.	Claims of Exemption (if any) and Circumstances thereof, and any other REMARKS on PROPERTY.
						Acres.	Poles.	Square feet.			
98	Vacant	Phine Henry	"	"	"	16	80	"	Mr. Parker	132	
99		Shambaugh Geo	"	"	Barn 30 x 14	98	"	"	John Clay	784	
100		Snyder Christy	"	"	Barn 50 by 20	98	"	"	Geo Snyder	588	
101		do	"	"	"	50	"	"	do	25	
102		Snyder Geo	"	"	2 Barns	296	"	"	Peter Wax	2378	
103	Hugh Glenn	do	1 Cabin	"	"	175	"	"	do	175	
104		Shambaugh Christy	1	"	Barn 48 x 20	90	"	"	Robt Patton	675	
105		Leather Jacob	"	"	Barn 45 x 20	117	"	"	Alexander Logan	819	
106		Shambaugh Philip	"	"	Barn 40 x 18	88	"	"	Jacob Sumner	704	
107		Sharp John	"	"	Barn 56 x 20	170	80	"	John Wallace	1875 50	
108		Snyder Philip	"	"	Barn & Hill house	120	"	"	James Armstrong	780	

Pretty clearly there is a second Phillip Snyder from the one in East Pennsboro. It is tempting to say that this one may be related to George Snyder, living in the same area on a larger farm.

## John & Catherine Snyder - Clues

It appears that Phillip's Frankford dwelling is a log structure. (Similar information is available for George Snyder.) See <https://www.ancestry.com/discoveryui-content/view/326521:2060?tid=&pid=&queryId=540d2b28654c4e3479c5ff5b14f38343&phsrc=xly614&phstart=successSource>

74	Snyder Phillip	Snyder Phillip	1	26	27	Log	2	8	96	1	2	213	"	213	"
															181

And, Phillip has a barn made of logs! See <https://www.ancestry.com/discoveryui-content/view/326667:2060?tid=&pid=&queryId=540d2b28654c4e3479c5ff5b14f38343&phsrc=xly614&phstart=successSource>

108	Snyder Phillip	Snyder Phillip										120		780	"	780	"

Barn of logs 56 ft by 20  
 Still House Log 20 ft by 18  
 Adjoining James Armstrong's



# John & Catherine Snyder - Clues

## PA Tax and Exoneration 1768-1801

To complement the previous section, I used other tax list information at ancestry.com ( <https://www.ancestry.com/search/collections/2497/> ) and searched for entries with the name Snyder in Cumberland County, yielding a list with 161 entries. Filtering this down to just the name Phillip Snyder produced a more manageable list of 20 entries as follows.

Year	Town or Ward
1778	East Pennsboro
1782	East Pennsboro
1782	East Pennsboro
1785	East Pennsboro
1785	East Pennsboro
1786	East Pennsboro
1786	East Pennsboro
1786	East Pennsboro
1787	East Pennsboro
1787	East Pennsboro
1788	East Pennsboro
1788	East Pennsboro
1789	East Pennsboro
1789	East Pennsboro
1787	West Pennsboro
1787	West Pennsboro
1788	West Pennsboro
1788	West Pennsboro
1789	West Pennsboro
1789	West Pennsboro

Summarized slightly differently . . .

Town or Ward	1778	1782	1785	1786	1787	1788	1789	Total Result
East Pennsboro	1	2	2	3	2	2	2	14
West Pennsboro					2	2	2	6
<b>Total Result</b>	<b>1</b>	<b>2</b>	<b>2</b>	<b>3</b>	<b>4</b>	<b>4</b>	<b>4</b>	<b>20</b>

This indicates that first (and the most) tax payments were in East Pennsboro, followed later by those in West Pennsboro. Here are some examples.

# John & Catherine Snyder - Clues

## East Pennsboro – Phillip Snyder

1778: See <https://www.ancestry.com/discoveryui-content/view/1057195:2497?tid=&pid=&queryId=d73921094e07043bd32e2370e368581a&phsrc=xly627&phstart=successSource> . 161 acres, one horse, one cow.

200 30	Snyder Phillip	2	154:0	9:30
	161 Acres Valued at \$1000		8:1:0	
	1 Horse 1 Cow			
50 16	Snyder Paul		10:0:0	10:0:0

1782: by this time, he had 150 acres, 2 horses and 4 cows! See <https://www.ancestry.com/discoveryui-content/view/1861047:2497?tid=&pid=&queryId=d73921094e07043bd32e2370e368581a&phsrc=xly627&phstart=successSource> .

150	Snyder Phillip	262	
	2 Horses	20	
	4 Cows	16	298

But in this record there are an additional 6 sheep. See <https://www.ancestry.com/discoveryui-content/view/1880255:2497?tid=&pid=&queryId=d73921094e07043bd32e2370e368581a&phsrc=xly627&phstart=successSource> .

150	Snyder Phillip	125	
	2 Horses	30	
	4 Cows	16	
	6 Sheep	2.5	173.5

## John & Catherine Snyder - Clues

1785: See [https://www.ancestry.com/discoveryui-content/view/1284095:2497?tid=&pid=&queryId=d73921094e07043bd32e2370e368581a&\\_phsrc=xly627&\\_phstart=successSource](https://www.ancestry.com/discoveryui-content/view/1284095:2497?tid=&pid=&queryId=d73921094e07043bd32e2370e368581a&_phsrc=xly627&_phstart=successSource).

N.º of acres	Eastpennsbro <sup>64</sup> <i>lates 1785</i>	Taxes	Total
135	<i>Saylor Matthias</i> 3 horses 2 Cows	270 24 8	302
150	<i>Snyder Philip</i> 3 horses 3 Cows	262-10 30 12	304-10

Another record shows the following. See

[https://www.ancestry.com/discoveryui-content/view/1893101:2497?tid=&pid=&queryId=d73921094e07043bd32e2370e368581a&\\_phsrc=xly627&\\_phstart=successSource](https://www.ancestry.com/discoveryui-content/view/1893101:2497?tid=&pid=&queryId=d73921094e07043bd32e2370e368581a&_phsrc=xly627&_phstart=successSource). I guess that the numbers indicate the amount of tax (pounds, shillings, pence?).

<i>Saylor Matthias</i>	1	5	2
<i>Snyder Philip</i>	1	5	5
<i>St. A.</i>	1	1	4

1786: See [https://www.ancestry.com/discoveryui-content/view/1292400:2497?tid=&pid=&queryId=d73921094e07043bd32e2370e368581a&\\_phsrc=xly627&\\_phstart=successSource](https://www.ancestry.com/discoveryui-content/view/1292400:2497?tid=&pid=&queryId=d73921094e07043bd32e2370e368581a&_phsrc=xly627&_phstart=successSource). In this year, Phillip has 3 horses and 3 cows. The acreage is the same (150 acres).

1787: See [https://www.ancestry.com/discoveryui-content/view/1313402:2497?tid=&pid=&queryId=d73921094e07043bd32e2370e368581a&\\_phsrc=xly627&\\_phstart=successSource](https://www.ancestry.com/discoveryui-content/view/1313402:2497?tid=&pid=&queryId=d73921094e07043bd32e2370e368581a&_phsrc=xly627&_phstart=successSource). Same acreage, 3 horses and 3 cows.

1788: See [https://www.ancestry.com/discoveryui-content/view/1331194:2497?tid=&pid=&queryId=d73921094e07043bd32e2370e368581a&\\_phsrc=xly627&\\_phstart=successSource](https://www.ancestry.com/discoveryui-content/view/1331194:2497?tid=&pid=&queryId=d73921094e07043bd32e2370e368581a&_phsrc=xly627&_phstart=successSource)

## John & Catherine Snyder - Clues

e . Everything is the same except for the addition of one horse. Note that there is a Jacob Snider in the area with a much smaller farm.

1789: See <https://www.ancestry.com/discoveryui-content/view/1351384:2497?tid=&pid=&queryId=d73921094e07043bd32e2370e368581a&phsrc=xly627&phstart=successSource> . By this time, Phillip has just 3 horses and 3 cows, but he has acquired 60 additional acres. Jacob Snyder does not appear this time. The acreage size is consistent with the 1798 tax information given previously. We are probably looking at the same family.

210	Snider Philip - - - - -	315	245
	3 Horses 3 Cows	33	348-

### West Pennsboro – Phillip Snyder

1787: See <https://www.ancestry.com/discoveryui-content/view/1320806:2497?tid=&pid=&queryId=d73921094e07043bd32e2370e368581a&phsrc=xly627&phstart=successSource> . 60 acres, 2 horses and 2 cows.

60	Snider Phillip - - - - -	60	10
	2 horses 2 cows	23	83
300	Simons William		

1788: See <https://www.ancestry.com/discoveryui-content/view/1337560:2497?tid=&pid=&queryId=d73921094e07043bd32e2370e368581a&phsrc=xly627&phstart=successSource> . No apparent change/

1789: See <https://www.ancestry.com/discoveryui-content/view/1359590:2497?tid=&pid=&queryId=d73921094e07043bd32e2370e368581a&phsrc=xly627&phstart=successSource> . In this year, Phillip is being taxed on just a horse and a cow – no land.

# John & Catherine Snyder - Clues

## PA Septennial Census 1779-1863

Searching this collection ([https://www.ancestry.com/search/collections/2702/?name= selander&count=50&name x=s ps&residence= cumberland-pennsylvania-usa 789](https://www.ancestry.com/search/collections/2702/?name=selander&count=50&name_x=s_ps&residence=cumberland-pennsylvania-usa_789) ) produced 30 records of families in Cumberland County, spread across the 1793 and the 1800 PA census. Here is a table of the results sorted by “residence place.”

Name	Residence Year	Residence Place
John Snider	1800	Allen, Cumberland, Pennsylvania
Geo Snider	1800	Carlisle, Cumberland, Pennsylvania
George Snider	1793	Carlisle, Cumberland, Pennsylvania
Anthony Snider	1800	East Pennsboro, Cumberland, Pennsylvania
John Snider	1800	East Pennsboro, Cumberland, Pennsylvania
Philip Snider	1793	East Pennsboro, Cumberland, Pennsylvania
Philip Snider	1800	East Pennsboro, Cumberland, Pennsylvania
Philip Snider Senior	1800	East Pennsboro, Cumberland, Pennsylvania
Christy Snider	1800	Frankford, Cumberland, Pennsylvania
George Snider Senior	1800	Frankford, Cumberland, Pennsylvania
John Snider	1800	Frankford, Cumberland, Pennsylvania
Philip Snider	1800	Frankford, Cumberland, Pennsylvania
John Snyder	1793	Greenwood, Cumberland, Pennsylvania
Christian Snider	1793	Middleton, Cumberland, Pennsylvania
Henry Snider	1800	Newton, Cumberland, Pennsylvania
John Snider	1793	Newville, Cumberland, Pennsylvania
John Snyder	1800	Rye, Cumberland, Pennsylvania
John Snider	1800	Shippensburg, Cumberland, Pennsylvania
Danl Snider	1800	Toboyne, Cumberland, Pennsylvania
Davd Snider	1800	Toboyne, Cumberland, Pennsylvania
George Snider	1800	Toboyne, Cumberland, Pennsylvania
Henry Snider	1800	Tyrone, Cumberland, Pennsylvania
John Snider	1800	Tyrone, Cumberland, Pennsylvania
Peter Snider	1800	Tyrone, Cumberland, Pennsylvania
Chrisley Snider	1793	West Pennsboro, Cumberland, Pennsylvania
David Snider	1800	West Pennsboro, Cumberland, Pennsylvania
George Snider	1793	West Pennsboro, Cumberland, Pennsylvania
Peter Snider	1793	West Pennsboro, Cumberland, Pennsylvania
Philip Snider	1793	West Pennsboro, Cumberland, Pennsylvania
Snider	1793	West Pennsboro, Cumberland, Pennsylvania

# John & Catherine Snyder - Clues

Here are other views to support analysis. First, people by date and place. Roughly there are twice as many families in 1800 compared to 1793. This could be due to maturation of family members as well as to immigration.

Residence	Residence Place	Anthony Snider	Chrisley Snider	Christian Snider	Christy Snider	Danl Snider	Davd Snider	David Snider	Geo Snider	George Snider	George Snider Senior	Henry Snider	John Snider	John Snyder	Peter Snider	Philip Snider	Phillip Snider Senior	Snider	Total Result
1793	Carlisle, Cumberland, Pennsylvania									1									1
	East Pennsboro, Cumberland, Pennsylvania															1			1
	Greenwood, Cumberland, Pennsylvania													1					1
	Middleton, Cumberland, Pennsylvania				1														1
	Newville, Cumberland, Pennsylvania												1						1
	West Pennsboro, Cumberland, Pennsylvania		1							1						1	1		5
1800	Allen, Cumberland, Pennsylvania													1					1
	Carlisle, Cumberland, Pennsylvania								1										1
	East Pennsboro, Cumberland, Pennsylvania	1											1				1		4
	Frankford, Cumberland, Pennsylvania					1					1		1				1		4
	Newton, Cumberland, Pennsylvania											1							1
	Rye, Cumberland, Pennsylvania													1					1
	Shippensburg, Cumberland, Pennsylvania												1		1				1
	Toboyne, Cumberland, Pennsylvania						1	1		1									3
	Tyrone, Cumberland, Pennsylvania											1	1			1			3
	West Pennsboro, Cumberland, Pennsylvania								1										1
<b>Total Result</b>		<b>1</b>	<b>1</b>	<b>1</b>	<b>1</b>	<b>1</b>	<b>1</b>	<b>1</b>	<b>1</b>	<b>1</b>	<b>3</b>	<b>1</b>	<b>2</b>	<b>6</b>	<b>2</b>	<b>2</b>	<b>4</b>	<b>1</b>	<b>30</b>

Next with a focus on locations by when and what people were there. The two clusters noted before are evident in West Pennsboro/Frankford and East Pennsboro. And, as noted before, there is a Phillip Snider in each cluster.

Name	Residence Year	Allen, Cumberland, Pennsylvania	Carlisle, Cumberland, Pennsylvania	East Pennsboro, Cumberland, Pennsylvania	Frankford, Cumberland, Pennsylvania	Greenwood, Cumberland, Pennsylvania	Middleton, Cumberland, Pennsylvania	Newton, Cumberland, Pennsylvania	Newville, Cumberland, Pennsylvania	Rye, Cumberland, Pennsylvania	Shippensburg, Cumberland, Pennsylvania	Toboyne, Cumberland, Pennsylvania	Tyrone, Cumberland, Pennsylvania	West Pennsboro, Cumberland, Pennsylvania	Total Result
Anthony Snider	1800				1										1
Chrisley Snider	1793														1
Christian Snider	1793						1								1
Christy Snider	1800					1									1
Danl Snider	1800												1		1
Davd Snider	1800												1		1
David Snider	1800													1	1
Geo Snider	1800		1												1
George Snider	1793		1												2
	1800												1		1
George Snider Senior	1800					1									1
Henry Snider	1800							1						1	2
John Snider	1793								1						1
	1800	1			1	1						1		1	5
John Snyder	1793						1								1
	1800									1					1
Peter Snider	1793													1	1
	1800													1	1
Philip Snider	1793				1										2
	1800				1	1									2
Phillip Snider Senior	1800				1										1
Snider	1793														1
<b>Total Result</b>		<b>1</b>	<b>2</b>	<b>5</b>	<b>4</b>	<b>1</b>	<b>1</b>	<b>1</b>	<b>1</b>	<b>1</b>	<b>1</b>	<b>3</b>	<b>3</b>	<b>6</b>	<b>30</b>

# John & Catherine Snyder - Clues

## Phillip Snyder Examples

Focusing just on Phillip Snyder families, here is some more specific information for illustration purposes.

### 1793 Phillip Snyder in East Pennsboro Twp

See [https://www.ancestry.com/discoveryui-content/view/804298:2702?tid=&pid=&queryId=662d92a35e870c2f77957f57d0c9db00&\\_phsrc=xly630&\\_phstart=successSource](https://www.ancestry.com/discoveryui-content/view/804298:2702?tid=&pid=&queryId=662d92a35e870c2f77957f57d0c9db00&_phsrc=xly630&_phstart=successSource)

. Phillip is shown as a farmer.

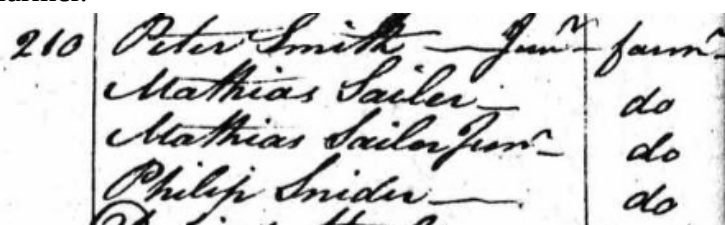

### 1793 Phillip Snyder in West Pennsboro Twp

See [https://www.ancestry.com/discoveryui-content/view/806798:2702?tid=&pid=&queryId=662d92a35e870c2f77957f57d0c9db00&\\_phsrc=xly630&\\_phScreenshot at 2023-04-24 13-50-28start=successSource](https://www.ancestry.com/discoveryui-content/view/806798:2702?tid=&pid=&queryId=662d92a35e870c2f77957f57d0c9db00&_phsrc=xly630&_phScreenshot%20at%202023-04-24%2013-50-28start=successSource)

. This Phillip (position 126) is a farmer as well. And, for what it is worth, a Simon Culp family is shown at position 149. Important information??



## John & Catherine Snyder - Clues

### 1800 Phillip Snyder in East Pennsboro Twp

See <https://www.ancestry.com/discoveryui-content/view/808519:2702?tid=&pid=&queryId=7b0690a22dbde11965bd55d783287144&phsrc=xly631&phstart=successSource>. There are two entries for Phillip Snyder. Both are shown as farmers. One (the “senior”) is listed next to John Snyder. And, again there is a Culp family nearby – Jacob Culp (86<sup>th</sup> “C” entry).

East Pennsboro Taxables	
406	Snyder Philip farmer 1833 Thompson
85	Ensmley John
86	Culp Jacob wag. maker

384	Snyder Philip sen farmer
385	Snyder John Do

### 1800 Phillip Snyder in Frankford Twp

See <https://www.ancestry.com/discoveryui-content/view/808700:2702?tid=&pid=&queryId=7b0690a22dbde11965bd55d783287144&phsrc=xly631&phstart=successSource>. This page shows four Snyder families for George, Christy, John, and Phillip. All are farming.

Frankford Taxables	
95	Sharp John Farmer
96	Shumbough Philip Do
97	Shumbough George Do.
98	Lansebaugh Christy Do.
99	Snyder Philip farmer
100	Snyder George sen Do.
101	Snyder Christy Do.
102	Snyder John Do.
119	Wilson Samuel farmer
120	Worst Jacob Do.
121	Worst Henry Do.
122	Wax Peter Do.
123	Wax Henry Do.
124	Wax Philip Do.
125	Willison Joseph Blmth
126	Wallace Pat. farmer



# John & Catherine Snyder - Clues

## 1790-1830 Federal Census Enumerations

This section is devoted to a review of Cumberland County census information for the time period 1790-1830. First there is a review of information from familysearch.org for Selanders and Culp families. A section for Snyder families follows.

### Selanders Families

See the separate document devoted to descendants of Christian Selanders for details. Valentine, Francis, and William are circled because of their familial relationships and because William is associated with John & Catherine Snyder in the 1850 OH census.

<b>John Solander</b> Sex: Unknown Principal United States Census, 1830	<b>Census</b> 1830 North Middleton Township, Cumberland, Pennsylvania, United States
<b>Francis Solander</b> Sex: Unknown Principal United States Census, 1830	<b>Census</b> 1830 Allen, Cumberland, Pennsylvania, United States
<b>Valentine Selander</b> Sex: Unknown Principal United States Census, 1810	<b>Census</b> 1810 East Pennsboro Township, Cumberland, Pennsylvania, United States
<b>Wm Solander</b> Sex: Unknown Principal United States Census, 1830	<b>Census</b> 1830 Silver Spring Meeting House, Hampden Township, Cumberland, Pennsylvania, United States

Plus, there is the 1830 record that shows entries for Valentine Selanders and Simon Culp next to each other.. - See "United States Census, 1830," database with images, *FamilySearch* (<https://familysearch.org/ark:/61903/3:1:33SQ-GYBQ-9DH3?cc=1803958&wc=35YC-LL2%3A1588474703%2C1588471902%2C1588476504> : 14 August 2015), Pennsylvania > Cumberland > Silver Spring > image 15 of 22; citing NARA microfilm publication M19, (Washington D.C.: National Archives and Records Administration, n.d.).

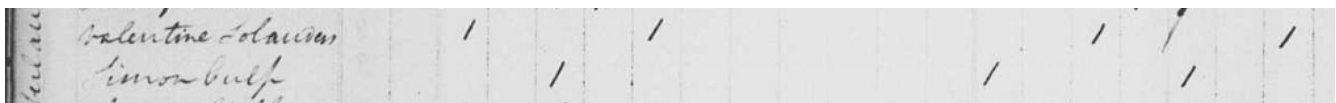

Here can be found information about the Silver Spring Meeting House mentioned with William Solander above: <http://www.silverspring.org/beliefs> . This happens to be the location of the marriage of Simon Culp to Ellen Selanders (William's sister) in 1828. The church is in Mechanicsburg, on the border between Silver Spring Twp and Hampden Twp.

# John & Catherine Snyder - Clues

## Culp Families

See the separate document about Culp families for details. The Simon Culp name is circled because of the association of that name with the family of John & Catherine Snyder in the 1850 OH census.

The 1830 entry is the one already mentioned in which the entry for Simon is next to that for Valentine Selanders. This Simon and his wife are in their 20s, with one young girl (under 5). Circumstantial evidence of a relationship. (Simon's wife, Ellen, is a daughter of Valentine.) Also worth noting is that Emminger families appear on this page. This is a name that appears in at least one of the baptismal records for the children of Phillip Snyder.

The entry in 1800 in Frankford Twp can not be the same Simon Culp because he was probably not born at the time. This may be a record of his purported father of the same name. This Simon Culp is between 27-45 and his wife may be older. They have a number of small children, four girls under 10, one of whom might be the Catherine that married John Snyder.

The 1810 entry may be for the elder Culp's family. If so, the family has added many children in the preceding decade. (boys: 4 under 10, 2 between 10-15; girls: 1 under 10, 3 between 10-15, and 1 between 16-25) The older girl could be the Catherine that I seek. Simon (b.~1801) and his younger brothers would easily fit as well.

<b>Simon Culp</b> United States Census, 1830	<b>Census</b> 1830 Silver Spring Township, Cumberland, Pennsylvania, United States
<b>Wm Culp</b> United States Census, 1830	<b>Census</b> 1830 Shippensburg, Cumberland, Pennsylvania, United States
<b>Simon Culp</b> United States Census, 1800	<b>Census</b> 1800 Frankford Township, Cumberland, Pennsylvania, United States
<b>Jacob Culp</b> United States Census, 1820	<b>Census</b> 1820 Middleton Township, Cumberland, Pennsylvania, United States
<b>Leah Culp</b> United States Census, 1830	<b>Census</b> 1830 Frankford Township, Cumberland, Pennsylvania, United States
<b>Jacob Culp</b> United States Census, 1820	<b>Census</b> 1820 Shippensburg, Cumberland, Pennsylvania, United States
<b>Simon Culp</b> United States Census, 1810	<b>Census</b> 1810 Mifflin Township, Cumberland, Pennsylvania, United States
<b>Jacob Culp</b> United States Census, 1830	<b>Census</b> 1830 Shippensburg Township, Cumberland, Pennsylvania, United States
<b>Craft Culp</b> United States Census, 1810	<b>Census</b> 1810 Frankford Township, Cumberland, Pennsylvania, United States
<b>Jacob Culp</b> United States Census, 1810	<b>Census</b> 1810 Shippensburg, Cumberland, Pennsylvania, United States
<b>David Culp</b> United States Census, 1820	<b>Census</b> 1820 Frankford Township, Cumberland, Pennsylvania, United States
<b>Craft Culp</b> United States Census, 1820	<b>Census</b> 1820 Frankford Township, Cumberland, Pennsylvania, United States

# John & Catherine Snyder - Clues

## Snyder Families

### 1790

The one entry that I found for Phillip Snyder identifies one such person in the western part of the county as follows. This is consistent with part of the 1793 census information presented above. (The Phillip Snyder in East Pennsboro is not found. Perhaps his family is a later arrival.)

Name: Philip Snider

Event Type: Census

Event Date: 1790

Event Place: Newton Township, Cumberland, Pennsylvania, United States

Event Place (Original): Hopewell, Newton, Tyborn, and Westpensboro, Cumberland, Pennsylvania, United States

Line Number: 18287

Page Number: 7

Affiliate Publication Number: M637

Affiliate Name: The U.S. National Archives and Records Administration (NARA)

Digital Folder Number: 005157140

Microfilm Number: 0568148

Image Number: 526

Citing this Record

"United States Census, 1790", database with images, *FamilySearch* (ark:/61903/1:1:XHKJ-L92 : Wed Mar 15 08:05:41 UTC 2023), Entry for Philip Snider, 1790.



1 male over 16, 1 male under 16, 3 females, no slaves or black folks.

# John & Catherine Snyder - Clues

## 1800

Families of possible interest are circled.

The Phillip Snyder entries are as expected based on the 1793 census and tax information from assorted years.

The one in Frankford Twp is between 27-45 years old, has a wife in the same range, and there are two sons (0-10 and 11-16) and six daughters (five under 10 and one between 11-16).

The one in East Pennsboro/Allen Twp is also between 27-45 years old, but his wife is younger (17-26). Also present are one young son and two young daughters, all under 10 years old. Probably this is the family of the Phillip Snyder b.1774 mentioned above in the baptismal records from St. Stephen's Church in New Kingstown. See

It is not clear how/if these two people of roughly the same generation are related.

<b>Henry Snider</b> United States Census, 1800	<b>Census</b> 1800 Cumberland, Pennsylvania, United States
<b>Peter Snider</b> United States Census, 1800	<b>Census</b> 1800 Cumberland, Pennsylvania, United States
<b>Henry Snider Jr</b> United States Census, 1800	<b>Census</b> 1800 Cumberland, Pennsylvania, United States
<b>George Snider</b> United States Census, 1800	<b>Census</b> 1800 Cumberland, Pennsylvania, United States
<b>Joh Snider</b> United States Census, 1800	<b>Census</b> 1800 Cumberland, Pennsylvania, United States
<b>Michl Snider</b> United States Census, 1800	<b>Census</b> 1800 Frankford Township, Cumberland, Pennsylvania, United States
<b>Conrod Snider</b> United States Census, 1800	<b>Census</b> 1800 Allen, Cumberland, Pennsylvania, United States
<b>Henry Snider</b> United States Census, 1800	<b>Census</b> 1800 Newton Township, Cumberland, Pennsylvania, United States
<b>George Snider</b> United States Census, 1800	<b>Census</b> 1800 Carlisle, Cumberland, Pennsylvania, United States
<b>Jno Snider</b> United States Census, 1800	<b>Census</b> 1800 Shippensburg, Cumberland, Pennsylvania, United States
<b>Phillip Snider</b> United States Census, 1800	<b>Census</b> 1800 Frankford Township, Cumberland, Pennsylvania, United States
<b>George Snider</b> United States Census, 1800	<b>Census</b> 1800 West Pennsboro Township, Cumberland, Pennsylvania, United States
<b>Geo Snider</b> United States Census, 1800	<b>Census</b> 1800 Frankford Township, Cumberland, Pennsylvania, United States
<b>David Snider</b> United States Census, 1800	<b>Census</b> 1800 West Pennsboro Township, Cumberland, Pennsylvania, United States
<b>Phillip Snider</b> United States Census, 1800	<b>Census</b> 1800 Allen, Cumberland, Pennsylvania, United States
<b>Cowrod Snider</b> United States Census, 1800	<b>Census</b> 1800 Frankford Township, Cumberland, Pennsylvania, United States
<b>Anthony Snider</b> United States Census, 1800	<b>Census</b> 1800 East Pennsboro Township, Cumberland, Pennsylvania, United States
<b>Jno Snider</b> United States Census, 1800	<b>Census</b> 1800 Frankford Township, Cumberland, Pennsylvania, United States

# John & Catherine Snyder - Clues

See <https://www.familysearch.org/ark:/61903/3:1:33SQ-GR8K-959V?i=11&cc=1804228&personaUrl=%2Fark%3A%2F61903%2F1%3A1%3AXHRD-2CM> for the record os Phillip Snyder in Allen/East Pennsboro Twp above.

## 1810

No entries are highlighted here since Phillip Snyder does not appear and since the John Snyder that I am seeking is probably too young (6 +/-) to have land.

<b>Nicholas Snyder</b> United States Census, 1810	<b>Census</b> 1810 Cumberland, Pennsylvania, United States
<b>John Snyder</b> United States Census, 1810	<b>Census</b> 1810 Cumberland, Pennsylvania, United States
<b>Conrad Snyder</b> United States Census, 1810	<b>Census</b> 1810 Frankford Township, Cumberland, Pennsylvania, United States
<b>Henry Snider</b> United States Census, 1810	<b>Census</b> 1810 Cumberland, Pennsylvania, United States
<b>Abraham Snider</b> United States Census, 1810	<b>Census</b> 1810 Cumberland, Pennsylvania, United States
<b>John Snider</b> United States Census, 1810	<b>Census</b> 1810 Cumberland, Pennsylvania, United States
<b>George Snider</b> United States Census, 1810	<b>Census</b> 1810 Cumberland, Pennsylvania, United States
<b>Neter Snider</b> United States Census, 1810	<b>Census</b> 1810 Cumberland, Pennsylvania, United States
<b>Mary Snider</b> United States Census, 1810	<b>Census</b> 1810 Cumberland, Pennsylvania, United States
<b>John Snider</b> United States Census, 1810	<b>Census</b> 1810 Cumberland, Pennsylvania, United States
<b>George Snelder</b> United States Census, 1810	<b>Census</b> 1810 Frankford Township, Cumberland, Pennsylvania, United States
<b>John Snader</b> United States Census, 1810	<b>Census</b> 1810 Frankford Township, Cumberland, Pennsylvania, United States
<b>Fanny Snelder</b> United States Census, 1810	<b>Census</b> 1810 Carlisle, Cumberland, Pennsylvania, United States
<b>Henry Snelder</b> United States Census, 1810	<b>Census</b> 1810 Newton Township, Cumberland, Pennsylvania, United States
<b>David Snider</b> United States Census, 1810	<b>Census</b> 1810 West Pennsboro Township, Cumberland, Pennsylvania, United States

# John & Catherine Snyder - Clues

## 1820

No entries are highlighted here since Phillip Snyder does not appear and since the John Snyder that I am seeking is probably too young (16 +/-) to have land.

<b>Lewis Snyder</b> United States Census, 1820	<b>Census</b> 1820 Churchtown, Cumberland, Pennsylvania, United States
<b>John Snyder</b> United States Census, 1820	<b>Census</b> 1820 Shippensburg Township, Cumberland, Pennsylvania, United States
<b>David Snyder</b> United States Census, 1820	<b>Census</b> 1820 Frankford Township, Cumberland, Pennsylvania, United States
<b>Jacob Snyder</b> United States Census, 1820	<b>Census</b> 1820 Frankford Township, Cumberland, Pennsylvania, United States
<b>John Snyder</b> United States Census, 1820	<b>Census</b> 1820 Allen, Monroe Township, Cumberland, Pennsylvania, United States
<b>John Snyder</b> United States Census, 1820	<b>Census</b> 1820 Allen, Monroe Township, Cumberland, Pennsylvania, United States
<b>John Snyder</b> United States Census, 1820	<b>Census</b> 1820 Frankford Township, Cumberland, Pennsylvania, United States
<b>David Snyder</b> United States Census, 1820	<b>Census</b> 1820 Allen, Monroe Township, Cumberland, Pennsylvania, United States
<b>Henry Snyder</b> United States Census, 1820	<b>Census</b> 1820 Dickinson Township, Cumberland, Pennsylvania, United States
<b>Henry Snyder</b> United States Census, 1820	<b>Census</b> 1820 Allen, Cumberland, Pennsylvania, United States
<b>Henry Snyder</b> United States Census, 1820	<b>Census</b> 1820 Frankford Township, Cumberland, Pennsylvania, United States
<b>Elizabeth Snyder</b> United States Census, 1820	<b>Census</b> 1820 West Pennsboro Township, Cumberland, Pennsylvania, United States
<b>Conrad Snyder</b> United States Census, 1820	<b>Census</b> 1820 Frankford Township, Cumberland, Pennsylvania, United States
<b>Henry Snyder</b> United States Census, 1820	<b>Census</b> 1820 Frankford Township, Cumberland, Pennsylvania, United States
<b>Henry Snyder</b> United States Census, 1820	<b>Census</b> 1820 Newton Township, Cumberland, Pennsylvania, United States
<b>John Snyder</b> United States Census, 1820	<b>Census</b> 1820 Allen, Monroe Township, Cumberland, Pennsylvania, United States
<b>Joseph Snyder</b> United States Census, 1820	<b>Census</b> 1820 Newton Township, Cumberland, Pennsylvania, United States
<b>George Snyder</b> United States Census, 1820	<b>Census</b> 1820 Middletown Township, Cumberland, Pennsylvania, United States

# John & Catherine Snyder - Clues

## 1830

Here are the results of a query for just John Snyder families. This is the first census in which the John Snyder that I am seeking would be expected to (maybe) have a residence and family of his own.

A few entries are selected circled based on proximity of other people of interest (e.g., Selanders, Culp, Phillip Snyder). These are just arbitrary and speculative selections. The only entries not selected are those for Centre County and South Middleton Twp.

There are six entries of potential interest based on this filter. Each is

<b>John Snyder</b> United States Census, 1830	<b>Census 1830</b> Union Township, Centre, Pennsylvania, United States
<b>John Snyder</b> United States Census, 1830	<b>Census 1830</b> Allen, Cumberland, Pennsylvania, United States
<b>John Snyder</b> United States Census, 1830	<b>Census 1830</b> West Pennsboro Township, Cumberland, Pennsylvania, United States
<b>John Snyder</b> United States Census, 1830	<b>Census 1830</b> Frankford Township, Cumberland, Pennsylvania, United States
<b>John Snyder</b> United States Census, 1830	<b>Census 1830</b> Frankford Township, Cumberland, Pennsylvania, United States
<b>John Snyder</b> United States Census, 1830	<b>Census 1830</b> South Middleton Township, Cumberland, Pennsylvania, United States
<b>John Snyder</b> United States Census, 1830	<b>Census 1830</b> Newton Township, Cumberland, Pennsylvania, United States
<b>John Snyder</b> United States Census, 1830	<b>Census 1830</b> Frankford Township, Cumberland, Pennsylvania, United States

examined below based on the assumption that in 1830 John and Catherine would be about 26 and 35, respectively, and they would have had no children based on the 1850 OH census.

- 1) Allen Twp: parents too old (?), one small child. See "United States Census, 1830," database with images, *FamilySearch* (<https://familysearch.org/ark:/61903/3:1:33SQ-GYBQ-98LH?cc=1803958&wc=35YC-LLJ%3A1588474703%2C1588471902%2C1588476505> : 14 August 2015), Pennsylvania > Cumberland > Allen > image 27 of 28; citing NARA microfilm publication M19, (Washington D.C.: National Archives and Records Administration, n.d.). Based on spatial association with Selanders and Culp data this is the most interesting John Snyder family of the lot, however.
- 2) West Pennsboro Twp: parents too old, way too many children. See "United States Census, 1830," database with images, *FamilySearch* (<https://familysearch.org/ark:/61903/3:1:33S7-9YBQ-9787?cc=1803958&wc=35YC-2KQ%3A1588474703%2C1588471902%2C1588477942> : 14 August 2015), Pennsylvania >

## John & Catherine Snyder - Clues

- Cumberland > West Pennsboro > image 19 of 20; citing NARA microfilm publication M19, (Washington D.C.: National Archives and Records Administration, n.d.).
- 3) Frankford Twp (1): parents too old, too many children. See "United States Census, 1830," database with images, *FamilySearch* (<https://familysearch.org/ark:/61903/3:1:33SQ-GYBQ-986K?cc=1803958&wc=35YC-LL6%3A1588474703%2C1588471902%2C1588477104> : 14 August 2015), Pennsylvania > Cumberland > Frankford > image 11 of 16; citing NARA microfilm publication M19, (Washington D.C.: National Archives and Records Administration, n.d.).
  - 4) Frankford Twp (2): This is a duplicate! - parents too old, too many children. See "United States Census, 1830," database with images, *FamilySearch* (<https://familysearch.org/ark:/61903/3:1:33SQ-GYBQ-986K?cc=1803958&wc=35YC-LL6%3A1588474703%2C1588471902%2C1588477104> : 14 August 2015), Pennsylvania > Cumberland > Frankford > image 11 of 16; citing NARA microfilm publication M19, (Washington D.C.: National Archives and Records Administration, n.d.).
  - 5) Newton Twp: Parents too old, too many children. See "United States Census, 1830," database with images, *FamilySearch* (<https://familysearch.org/ark:/61903/3:1:33SQ-GYBQ-94NZ?cc=1803958&wc=35YC-2K9%3A1588474703%2C1588471902%2C1588476501> : 14 August 2015), Pennsylvania > Cumberland > Newton > image 11 of 16; citing NARA microfilm publication M19, (Washington D.C.: National Archives and Records Administration, n.d.).
  - 6) Frankford Twp (3): Parents are about the right age, wife may be too young; two small boys. See "United States Census, 1830," database with images, *FamilySearch* (<https://familysearch.org/ark:/61903/3:1:33S7-9YBQ-9H2C?cc=1803958&wc=35YC-LL6%3A1588474703%2C1588471902%2C1588477104> : 14 August 2015), Pennsylvania > Cumberland > Frankford > image 9 of 16; citing NARA microfilm publication M19, (Washington D.C.: National Archives and Records Administration, n.d.).
  - 7) BTW, the Middleton Twp family looks like two families in one residence – an older one and a younger one. Many more children that would be expected.

A similar query for Jacob Snyder returned an empty set. Looking for Schneider/Snider also made no difference.

And, as another note, there is a Phillip Snyder in Union Twp, Centre County, to go along with the John Snyder in Centre County above. Phillip is in his 30s and his wife is in her 20s, and they have one small boy. Actually there are many Snyder families in Union Twp. The John Snyder one has four children, the man is in his 20s, but the woman in the family is in her 60s. Consequently, these families are eliminated from consideration.

If John and Catherine are married by 1830, they most likely do not appear in the Cumberland County census for 1830. There are many possible reasons for this – not married yet for example.



# John & Catherine Snyder - Clues

## Geographically Based PA Summary

### Fundamentals

In this section, I pursue the representation of the evidence in spatial terms to help draw the best conclusions possible. The evidence includes the following types of items.

- Locations of select Snyder families identified as “first families” by the Cumberland County Historical Society. See Historical Society of Cumberland Co. First Families: <https://www.historicalsociety.com/collections/first-families-of-cumberland-county/>.
- Locations of Snyder families (especially those associated with the name Phillip Snyder) based on census enumerations from 1790-1830.
- Locations for Selanders and Culp families as explained in the other documents devoted to those lines. These are mostly locations based on PA census enumerations and tax rolls.

For more information about Pennsylvania mapping resources see sites like . . .

- Penn State: <https://sites.psu.edu/mapsgislib/pennsylvania-early-county-maps-and-altases/>
- Pennsylvania Historical and Museum Commission: <http://www.phmc.state.pa.us/bah/dam/mg/mg11.htm>
- The earliest extant map of Cumberland Co. appears to be this 1858 map.: <https://www.loc.gov/resource/g3823c.la000733/?r=0.491%2C0.146%2C0.087%2C0.04%2C0>
- In many of the topics that follow, it helps to understand the organization of Cumber Co., PA, into townships. This organization was not static, and the following reference explains the evolution of the townships. See <http://pagenweb.org/~cumberland/towns.html> and <http://www.usgwarchives.net/maps/pa/county/cumber/usgs/>.

Briefly, the county is currently divided into 22 townships as shown here. According to the US Gen Web project referenced above, there were originally four townships - “Townships 1-6 were formed from the original **East Pennsborough Twp**; 7-9 from the original **Middleton Twp**; 10-15 from the original **West Pennsborough Twp**; 16-22 from the original **Hopewell Twp**.” Formation dates for the four “kernel townships” are 1745, 1810, 1745, and 1735, respectively. This is important because many of the sources used here date to times prior to the subdivision of the kernel townships.

The three largest cities (boroughs) in the county are **Shippensburg**, settled in 1733 and originally embedded in Hopewell Twp, **Carlisle**, settled in 1751 and embedded in Middleton Twp, and **Mechanicsburg**, settled in the early 1800s and straddling the boundary between Silver Spring and Allen Twps in the original East Pennsboro Twp.

Following is a copy of the 1858 map noted above, onto which I have drawn rough boundaries of the four original townships. I have also added tags (stars) to show locations of records associated with families



Township	Map #	Formed
East Pennsborough	1	1745
Hamden	2	1845
Lower Allen	3	1858
Upper Allen	4	1858
Silver Spring	5	1787
Monroe	6	1825
South Middleton	7	1810
North Middleton	8	1810
Middlesex	9	1859
West Pennsborough	10	1745
Dickinson	11	1785
Penn	12	1868
Cooke	13	1872
Upper Frankford	14	1929
Lower Frankford	15	1929
Hopewell	16	1735
Shippensburg	17	1783
Southampton	18	1783
South Newton	19	1929
North Newton	20	1929
Upper Mifflin	21	1892
Lower Mifflin	22	1892

# John & Catherine Snyder - Clues

that I regard as significant. There are obvious limitations reflecting limitations in the source records. For example, it may be hard to differentiate one Phillip Snyder from another, given that one Phillip Snyder father and his son had identical last names. Also, the fact that I have focused on the name Phillip Snyder based on a birth record that may or may not pertain to the John Snyder in whom I have an interest is an obvious limitation. Be that as it may, the tags cluster in two groups – one eastern and one western. Sections that follow examine the tags in each group.



Here is a list of the tags (stars) in the map above. Each refers to a fact described earlier in this document, and the cluster assignment is indicated by an E or a W.

cluster	tag	description
E	Star 01	Baptismal record of Johann Jacob Snyder from St. Stephen's Lutheran Church in New Kingstown.
	Star 04	Misc 18th century records for Phillip Snyder (tax 1793 & 1800 PA census) – East Pennsboro area
	Star 05	1830 Federal Census showing William Solander (Silver Spring Meeting House)
	Star 06	1830 Federal Census showing Francis Solander
	Star 07	1810 Federal Census showing Valentine Solander
	Star 08	1828 marriage of Simon Culp and Ellen Selanders
	Star 09	1830 Federal census showing Simon Culp and Valentine Selanders
	Star 13	1800 Federal Census showing Phillip Snyder; In the same area is a Jacob Culp (bag maker).
	Star 14	1830 Federal census showing John Snyder
W	Star 02	1800 Federal Census showing Phillip Snyder
	Star 03	Misc 18th century records for Phillip Snyder (tax 1793 & 1800 PA census) – Frankford Twp area.)A 1793 cens
	Star 10	1800 Federal Census showing Simon Culp
	Star 11	1810 Federal Census showing Simon Culp
	Star 12	1790 Federal Census showing Phillip Snyder
	Star 15	1830 Federal Census showing 3 John Snyder entries in Frankford Twp and 1 in West Pennsboro Twp

# John & Catherine Snyder - Clues

## Western Records Cluster

The tags associated with this group are . . .

**Star 02** - 1800 Federal Census showing Phillip Snyder

**Star 03** - Misc 18th century records for Phillip Snyder (tax 1793 & 1800 PA census) – Frankford Twp area.)

A 1793 census entry shows Simon Culp and Phillip Snyder in close proximity.

**Star 10** -1800 Federal Census showing Simon Culp

**Star 11** - 1810 Federal Census showing Simon Culp

**Star 12** - 1790 Federal Census showing Phillip Snyder

**Star 15** - 1830 Federal Census showing 3 John Snyder entries in Frankford Twp and 1 in West Pennsboro Twp

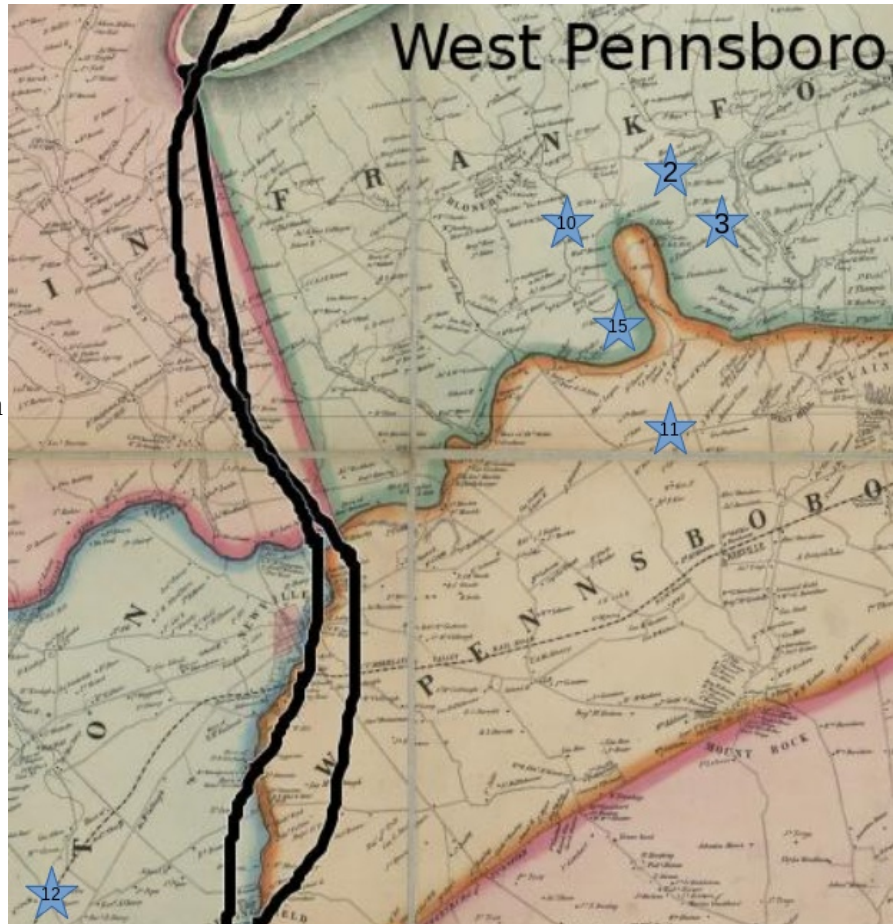

The instances of Simon Culp in the 1800 and 1810 census enumerations can not be for the Simon Culp who was a neighbor of John and Catherine Snyder in OH in 1850. They might apply to a relative of his who was one generation earlier (a father or uncle?).

As indicated earlier, a review of the 1830 census entries for John Snyder did not suggest that any of the four entries describe the family that I am seeking.

# John & Catherine Snyder - Clues

## Eastern Records Cluster

The eastern records are much more interesting. Towns of Mechanicsburg and New Kingstown are of some significance.

The tags associated with this group are . . .

**Star 01** - Baptismal record of Johann Jacob Snyder from St. Stephen's Lutheran Church in New Kingstown.

**Star 04** - Misc 18<sup>th</sup> century records for Phillip Snyder (tax, 1793 & 1800 PA census) – East Pennsboro Twp area.

**Star 05** -1830 Federal Census showing William Solander (Silver Spring Meeting House)

**Star 06** - 1830 Federal Census showing Francis Solander

**Star 07** - 1810 Federal Census showing Valentine Solander

**Star 08** - 1828 marriage of Simon Culp and Ellen Selanders at Presbyterian Church in Mechanicsburg.

**Star 09** - 1830 Federal census showing Simon Culp and Valentine Selanders

**Star 13** - 1800 Federal Census showing Phillip Snyder in same area as Jacob Culp (bag maker)

**Star 14** - 1830 Federal census showing John Snyder



The baptismal record (Star 1) is the basis of the speculation about the association of John Snyder (OH) with the Phillip Snyder family(ies) in Cumberland County. And, although the relation is truly speculative at this point, the geographic proximity to the other pieces of information make it very attractive.

Stars 4 and 13 represent multiple bits of information about the Phillip Snyder family that I believe lived just south of New Kingstown. This location of Star 3 fits with on-line information as well as a publication of the Cumberland County Historical Society – *First Families of Old Cumberland County: Vol. XVIII – Mechanicsburg and White Rocks*, by Eschenmann and Barner. Page 42 (and others) describe tracts of land associated with Phillip Snyder and Baltzer Snyder that lie just south of New Kingstown. Taken together

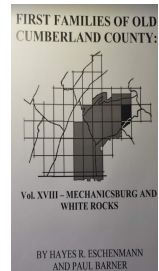

## John & Catherine Snyder - Clues

with the information presented earlier from St. Stephen's Lutheran Church in New Kingstown, there is a nice view of the Phillip Snyder families in the area – who the family members were and where they farmed. Here is an image of the part of the map that shows the tracts (MCH 40, 42, 120) owned by Phillip Snyder in the early 1800s. The distance between Mechanicsburg and New Kingstown is about 5 miles.

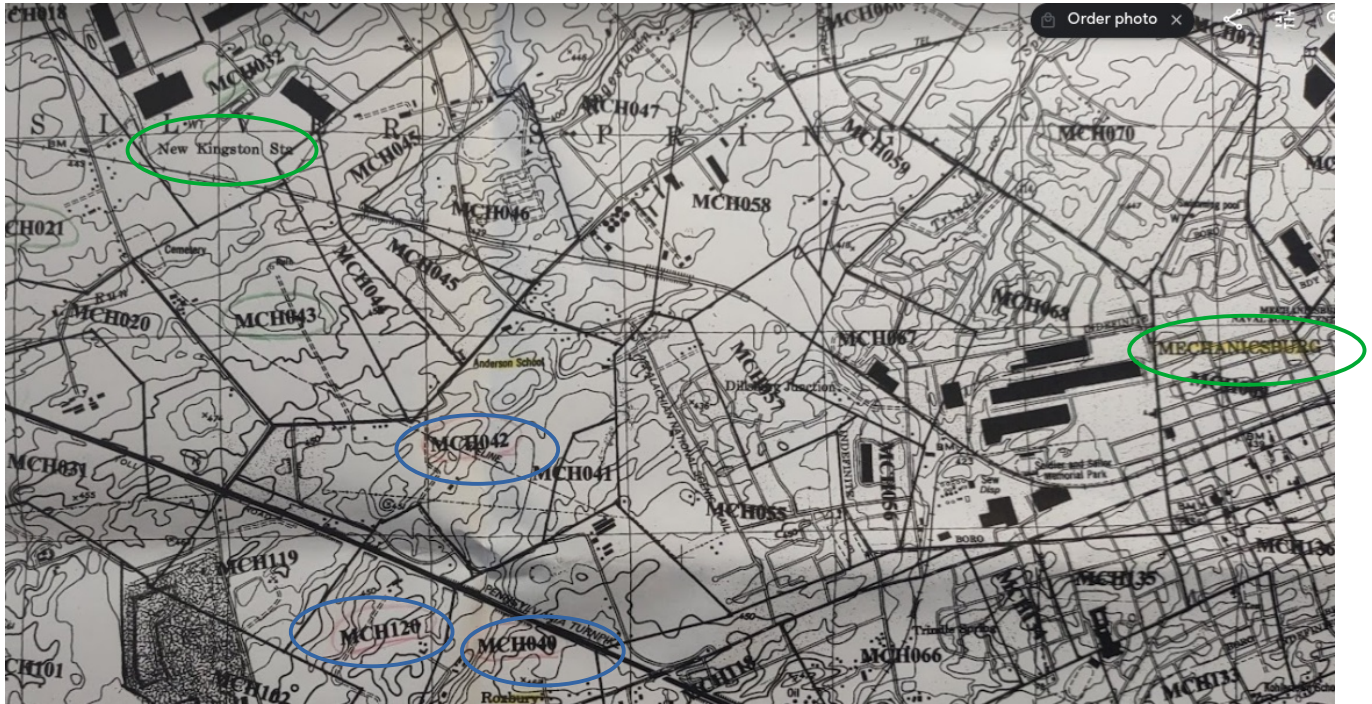

Three tags (Stars 5, 6, and 7) show rough locations associated with key males in the Solander/Selanders family that I have described in a separate document. Valentine and Francis are brothers, and William is the son of Valentine. William is also a neighbor of John Snyder and Simon Culp in OH in 1850. Their proximity to the Phillip Snyder and Simon Culp family is perhaps of significance. Star 5 is placed according to the Silver Spring Meeting House mentioned in the transcription of the 1830 census entry for William Selanders (Solander).

Star 8 indicates the location of the marriage of Simon Culp and Ellen Selanders in 1828, just before they moved to OH. Ellen is a daughter of Valentine Selanders (sister to William). These are neighbors of John and Catherine Snyder in OH in 1850. Simon is one of three brothers with whom I have established a genetic link to my mother. This is described in a separate document describing the Culp families.

Star 9 indicates the 1830 census entry for Simon Culp, which appears next to that for Valentine Selanders.

# John & Catherine Snyder - Clues

Lastly, Star 14 roughly locates an 1830 census entry for a John Snyder family that might be of interest. This is not clear, however.

## DNA Analysis

### Autosomal Matching

Using an approach similar to that used to find Culp connections at the time of about 1800, the following match was discovered. That has led to Sarah Snyder, who could be John Snyder's sister, which would explain the match.

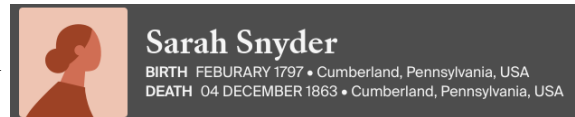

See <https://www.familysearch.org/tree/person/details/L8Q8-NWK> . The amount of matching DNA is 28cM, which is about right for a common ancestor living in about 1800. The bulk of the records associated with Sarah are geographically associated with Carlisle and just west of there (around Newville).

The match is at ancestry.com and a part of the tree there showing Sarah follows. See public tree <https://www.ancestry.com/family-tree/tree/49354441/family/pedigree?cfpid=20206413674> .

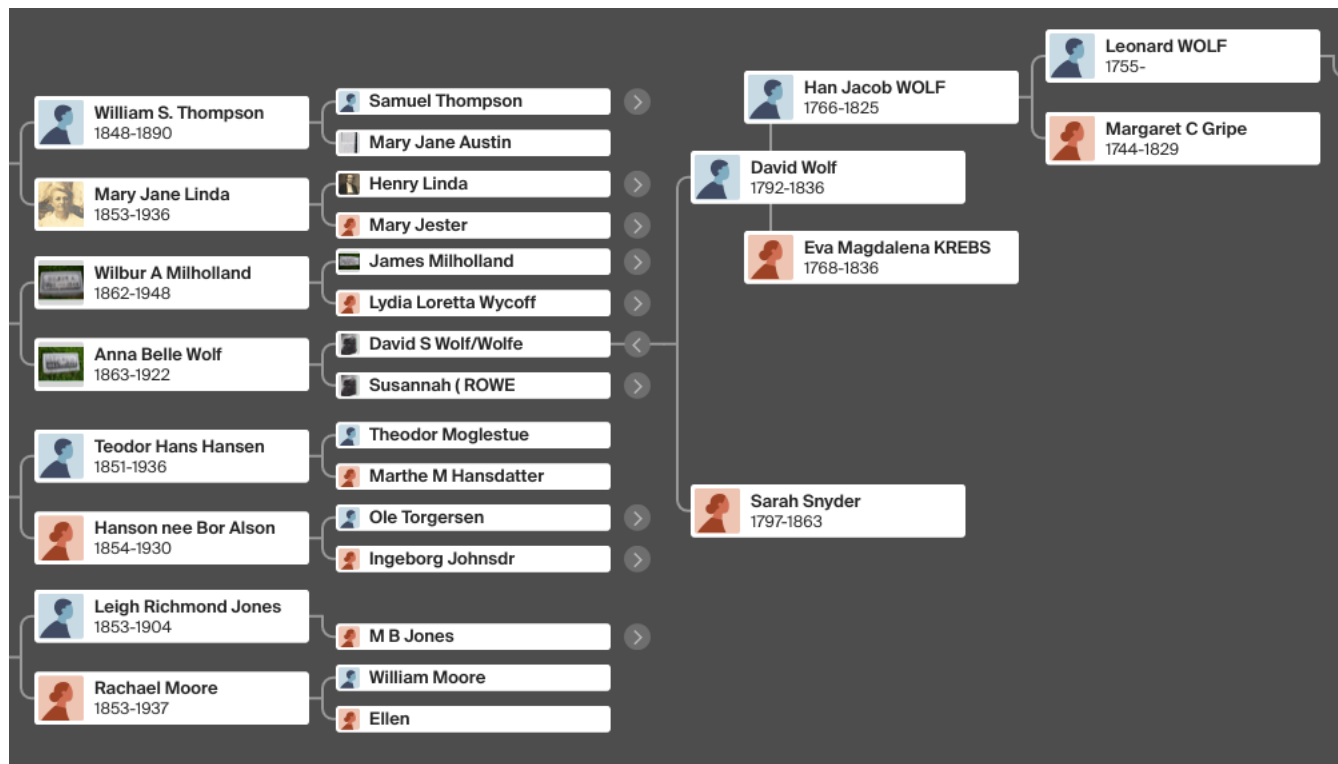

I have contacted the owner of the tree for details, if any exist.

# John & Catherine Snyder - Clues

## Mitochondrial DNA

As noted above, using the tree building facility at 23andme, I have constructed a tree based on autosomal matches for my mother. By inspection of descendants of Catherine Snyder along maternal lines, I have determined that her haplogroup is T2F1. This may be useful at some point.

## Conclusions

The fate of John and Catherine Snyder after 1850 has been so far impossible to determine. Perhaps there are records that would help understand their fates and the nature of their ancestors. I will continue to look with the help of a contacts in OH.

DNA evidence has provided a significant link of my mother to Simon Culp (b.~1801) and his brothers through her great grandmother Susannah Snyder (daughter of John and Catherine). This most likely argues in favor of Catherine being a sister of the Culp brothers. More information about the Culp family might prove/disprove the proposed nature of the relationship evidenced by the DNA matching.

Also, the possible connection to Sarah Snyder through DNA matching may prove to be very useful.

For now, however, even though built on circumstantial (spatial proximity) evidence, the best solution seems to be that John Snyder (b.1804 according to the 1850 census) is a son of Phillip Snyder (b.1774). And, his wife, Catherine, is a sister of the brothers Simon, Andrew, and Samuel Culp.

I have contacted the Cumberland County Historical Society to help find a marriage record for John and Catherine as well as a birth record for daughter Susannah. They may have additional information that I will pursue. Topics of particular interest are the New Kingstown area:

<https://ldsgenealogy.com/PA/New-Kingstown.htm> ; the Silver Spring Meeting House:  
<https://pennsylvania.hometownlocator.com/maps/feature-map.ftc,2,fid,1187693,n,silver%20spring%20meeting%20house.cfm> .

A bit of good luck would be welcome as well!

Here is a story that I keep in my head to keep all the information together. It may be totally fictitious. -

*The elder Phillip Snyder in the east settled near New Kingstown. His wife's name was Barbara. They may be connected somehow with the western Phillip and George Snyder clan. The western clan may have had an association with a Simon Culp who could be the father of Simon Culp (b.~1801).*

*The eastern elder Phillip had a family whose members were baptized in the Lutheran church in New Kingstown, near where the family had various tracts of land. The first son was also named Phillip, and his son Johann Jacob born in 1804 could be the person who appears as John Snyder in the 1850 OH census.*

# John & Catherine Snyder - Clues

Nearby to the Snyder family (within 5-10 miles) can be found families associated with Valentine Selanders. And a younger Simon Culp is clearly associated with these families. Perhaps a sister of Simon's named Catherine married John Snyder. Many of these families can be found in OH in 1850. There may be an association with Mennonite or Church of the Brethren Churches.

And, here is a speculative family tree that summarizes all of the suspicions raised in this document. It may be nonsense, but it fits what little information exists.

## A Speculative Family Tree

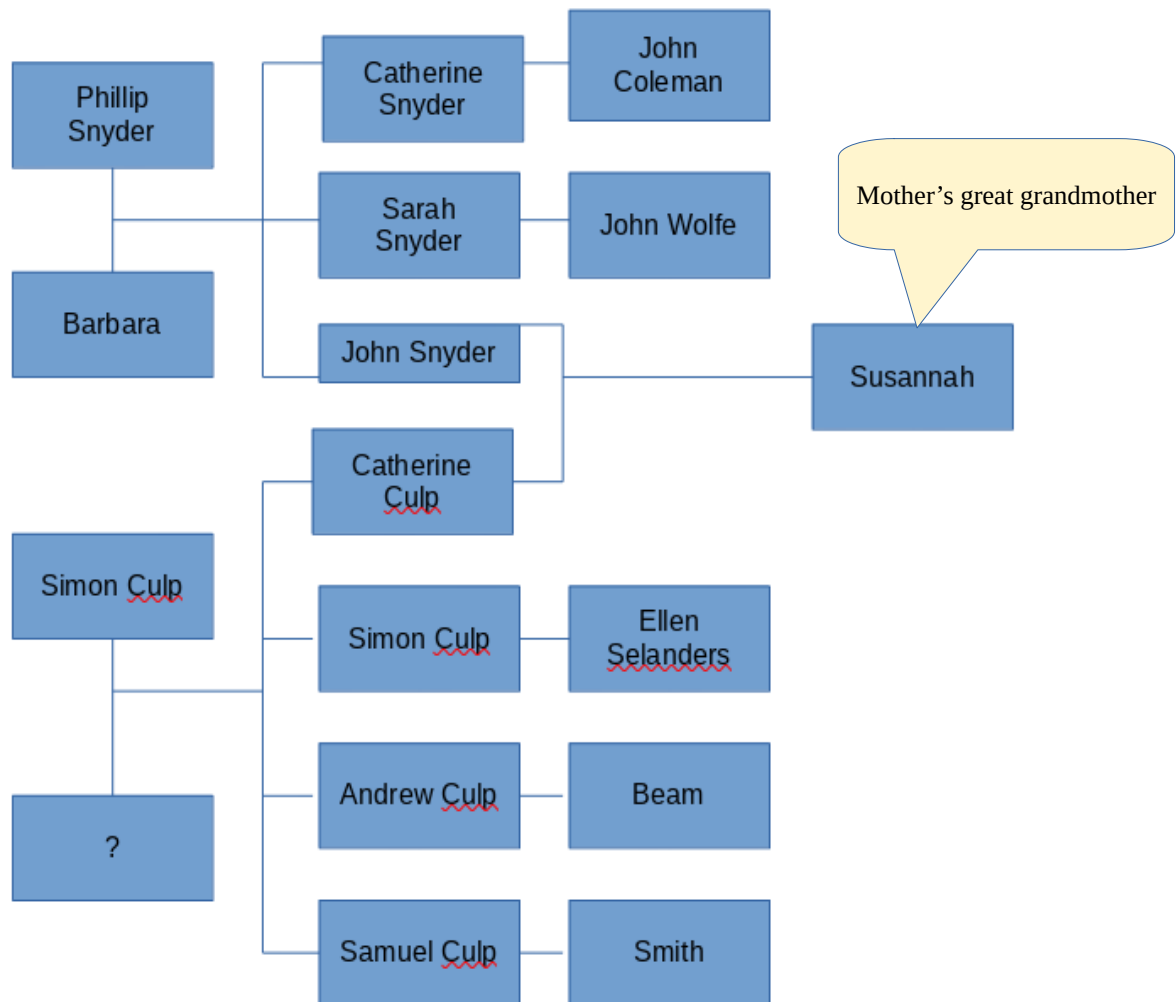



# John & Catherine Snyder - Clues

A proposed migration route - Cumberland Co., PA, via the National Road (~1833) to Columbus, OH ,  
Then north to Waldo (then in Delaware Co., OH) via road or Scioto River

## References:

- <https://prairierootsresearch.com/migration-routes-the-national-road/>
- 1840 OH map: <https://hdl.loc.gov/loc.gmd/g4080.ct011786>
- The Settlement of the Old Northwest: Ethnic Pluralism in a Featureless Plain, Author(s): Robert P. Swierenga, Source: Journal of the Early Republic , Spring, 1989, Vol. 9, No. 1 (Spring, 1989), pp. 73-105, Published by: University of Pennsylvania Press on behalf of the Society for Historians of the Early American Republic; Stable URL: <https://www.jstor.org/stable/3123525>

“But soon southern Pennsylvania became the beehive of Ohio's midsection. By 1850, over 200,000 Pennsylvanians, mainly Germans and Scotch-Irish, had swarmed into Ohio, where they comprised 43 percent of all migrants. This was twice as many as any other state and three times those of New Englanders. The Pennsylvania influence in Ohio was even greater before 1850, since many of the Ohio-born were children of Pennsylvania migrants.”

- page 80 in the journal previously cited, article by Swierenga.

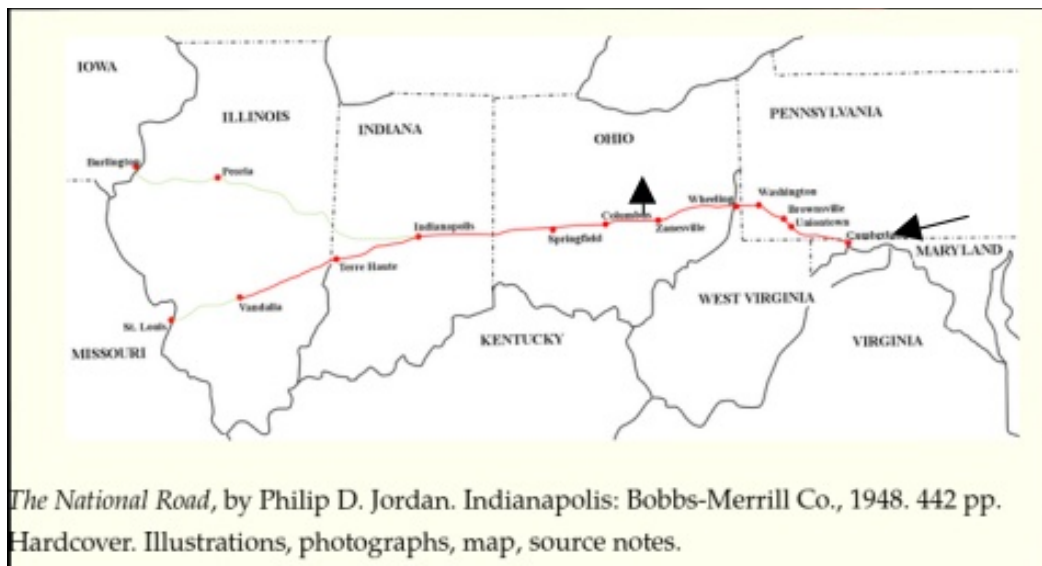

# John & Catherine Snyder - Clues

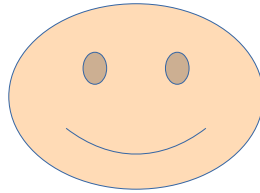

# Simon Culp and Ellen Selanders of PA, OH, KS

## Table of Contents

1 Introduction.....	4
2 Simon Culp (1801?-1893).....	6
2.1 Birth (1801 - PA).....	6
2.2 Marriage (1828 - PA) to Ellen Selanders (1806-1903).....	6
2.3 Children.....	6
2.3.1 Rachel (1829-1903) & Simon Burgraff.....	6
2.3.2 Caroline (1831-1920) & Bennet Glaze.....	7
2.3.3 John Valentine (1835-1918) & Julia Delozier.....	7
2.3.4 Malinda (1838-1920) & William Powell.....	7
2.3.5 Margaret (1839-1890) & William Patton.....	9
2.3.6 Mary Jane (1844-1893) & Philip Weiser.....	9
2.4 Census Records.....	9
2.4.1 1830 (PA - Silver Spring Twp, Cumberland Co., PA).....	9
2.4.2 1840 (OH).....	9
2.4.3 1850 (OH).....	10
2.4.4 1860 (OH).....	11
2.4.5 1870 (OH).....	11
2.4.6 1880 (KS).....	12
2.4.7 1900 (OH).....	12
2.5 Death (1893 - KS).....	12
3 Other Culp Families in OH.....	13
3.1 Andrew Culp (1809-1890).....	13
3.1.1 Birth (1809 - PA).....	13
3.1.2 Census Records and Marriage(s).....	13
3.1.2.1 First Marriage (1830-33) to Leah Beam.....	13
3.1.2.2 1840 census (PA).....	13
3.1.2.3 1850 census (PA).....	13
3.1.2.4 1860 census (OH).....	14
3.1.2.5 1870 Census (OH).....	14
3.1.2.6 Second Marriage (1871) to Sarah Bradford.....	15
3.1.2.7 1880 Census (KS).....	15
3.1.3 Death (1890 - KS).....	16
3.1.4 Children.....	16
3.1.4.1 Catherine Sophia (1834-1909) & Michael Hoke.....	16
3.1.4.2 Frances (1835-1919) & John Phillipy.....	16
3.1.4.3 John B. (1838-1928) & Catherine/Margaret Strine.....	17
3.1.4.4 Mariah (1840-1920) & Jacob Smith.....	17
3.1.4.5 Samuel (1842-1864).....	17
3.1.4.6 Andrew Simon Culp (1847-1922) & Mary Jane Boger (1848-1894).....	18
3.1.4.7 George (1851-1917) & Edna Algare/Algier/Elgar?.....	19
3.1.4.8 Sarah Phonetta (1853-1932) & Edward Robinson.....	19

# Simon Culp and Ellen Selanders of PA, OH, KS

3.2 Samuel Culp (1808-1881).....	20
3.2.1 Birth (1808-1809 - PA).....	20
3.2.2 Marriage (1840? - MD).....	20
3.2.3 Census Enumerations.....	20
3.2.3.1 1850 census (MD).....	20
3.2.3.2 1860 census (OH).....	21
3.2.3.3 1870 census (OH).....	21
3.2.3.4 1880 Census (IN).....	21
3.2.4 Children.....	22
3.2.4.1 Andrew Sherman Culp (1842-1902) & Sarah Ann Mattix.....	22
3.2.4.2 Mary (1844-1914) & Adam Boger.....	23
3.2.4.3 Ann (1849-1851?).....	23
3.2.4.4 Margaret (1857-1943) & John Mattix/William James.....	23
3.2.4.5 Leah (1859-1888).....	23
3.2.4.6 Charles E. (1863-1906) & Charlotte Gilbert.....	23
3.2.5 Death (1881 - IN).....	24
3.3 Jacob Culp (b.~1829 in Baden).....	25
3.4 Kate Culp (b.~1799 Baden).....	25
3.5 Peter Culp (b.1791 PA) and Susannah Braucher (b.1798).....	25
3.6 Anthony H. Culp (1814-1892) and Susanna Bixler (1821-1900).....	25
4 Misc. Leads.....	26
4.1 DNA.....	26
4.1.1 Example Ancestry.com Matches.....	28
4.1.1.1 SK (Simon Culp descendant)*.....	28
4.1.1.2 TS (Samuel Culp Descendant)*.....	28
4.1.1.3 DC (Andrew Culp Descendant)*.....	28
4.1.2 Example 23andme Matches.....	29
4.1.2.1 SH.....	29
4.1.2.2 MC*.....	29
4.1.2.3 HW*.....	29
4.1.3 Example familytreedna Matches.....	30
4.1.3.1 TS (Samuel Culp descendant)*.....	30
4.2 Pennsylvania Clues.....	31
4.2.1 Intriguing Snyder Birth/Baptismal Record.....	32
4.2.2 Cumberland Co. PA Tax Records.....	32
4.2.3 Review of Census Records.....	34
4.2.3.1 1800-1820 Census Enumerations.....	34
1800.....	34
1810.....	36
1820.....	39
4.2.3.2 1830 Census Enumerations.....	40
4.2.4 PA Church and Town Records.....	43
4.2.5 Pennsylvania Land Warrants & Applications.....	46
4.2.6 Anabaptist Records.....	47

## Simon Culp and Ellen Selanders of PA, OH, KS

4.2.6.1 Church of the Brethren Records.....	47
4.2.6.2 Mennonite Records.....	47
4.2.7 Possible Ancestors of Simon Culp (b. ~1801).....	48
4.2.7.1 Dielman Kolb (b.~1648).....	48
4.2.7.2 Kaspar Kolb (b.~1708).....	50
5 Conclusions.....	51

# Simon Culp and Ellen Selanders of PA, OH, KS

## 1 Introduction

By doing the research described below I hope to obtain some clues about the identity of the parents in the Snyder family shown in the 1850 Marion Co., OH, census – the Snyder family of John, Catherine, Susannah, Elizabeth, and George. This research starts with the family of Simon Culp and Ellen Selanders also shown in the 1850 Marion Co., OH, census. It expands to include other Culp families in the vicinity, some of which I believe are related to Simon Culp. In particular, one theory that emerges from this work is that Simon and two other Culp families living nearby (namely Andrew and Samuel) are brothers. Furthermore, I present some DNA evidence that Catherine Snyder is likely tied to the Culp family. There are other more complicated scenarios to explain the DNA matches, but the simplest explanation is that Catherine and Simon share a parent, i.e., they are siblings.

Here are images from the 1850 census that show Snyder, Culp, and Selanders families. See <https://www.familysearch.org/ark:/61903/1:1:MXQL-MKH> . Proposed relationships are labeled.

Ellen Culp is a sister to William Selanders.

Catherine Snyder is a sister to Simon Culp.

Name	Age	Sex	Occupation	Color
William Selanders	12	F		Pa
Ann	15	F		Pa
Samuel	17	M	Selander	Pa
Russell	1	F		Pa
Katy	11	F		Pa
Valentine	10	M		C
Francis	7	F		C
Sarah	2	F		C
John Snyder	16	M	Snyder	Pa
Catherine	15	F		Pa
Susannah	12	F		Pa
Elizabeth	10	F		C
George	18	M		C
Walter	6	F		C

  

Name	Age	Sex	Occupation	Color
Simon Culp	16	M	Carpenter	Pa
Ellen	15	F		Pa
Sarah	21	F		Pa
Catherine	18	F		Pa
Valentine	15	M		Pa
Andrew	13	F		C
Margaret	8	F		C
Indy	2	F		C
Stephen	22	M	Carpenter	Pa

I suspect that these three families migrated from PA and that they knew each other prior to the move. I also believe that many of the Culp families described here were members of the Church of the Brethren, which I believe is an Anabaptist group. If you follow some of the links pertaining to burials, you will see why I have come to this conclusion.

## Simon Culp and Ellen Selanders of PA, OH, KS

Following is a sketch that shows migration paths that the evidence supports for the proposed three brothers (Simon, Andrew, and Samuel). Everyone started in PA and passed through OH.

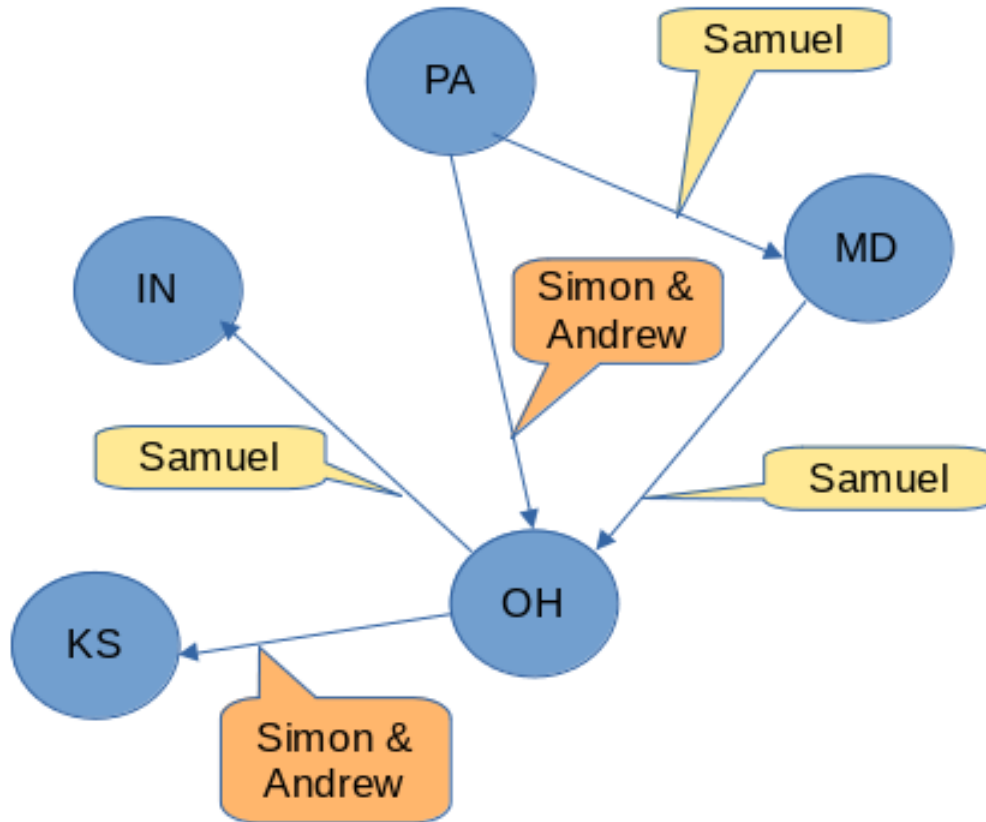

Now to the details, starting with Simon Culp and his family with Ellen Selanders.

# Simon Culp and Ellen Selanders of PA, OH, KS

## 2 Simon Culp (1801?-1893)

This is the Simon Culp whose family lived near the Selanders and Snyder families in Marion Co., OH, according to the 1850 census. I suspect that all three families had common ties to PA based on information this and other census records.

### 2.1 Birth (1801 - PA)

Indirectly estimated from various sources.

### 2.2 Marriage (1828 - PA) to Ellen Selanders (1806-1903)

This event is actually documented. They were married on March 20, 1828 in Silver Spring Presbyterian Church in Cumberland Co., PA.

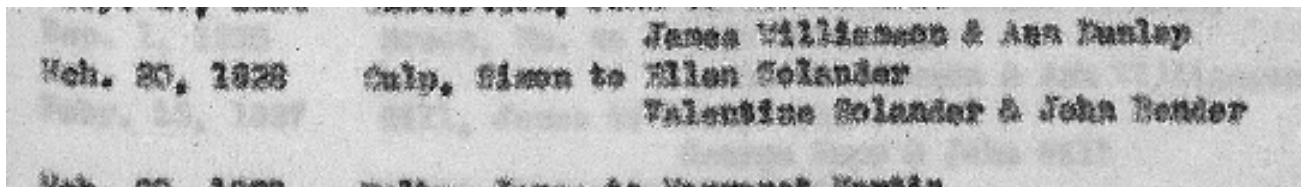
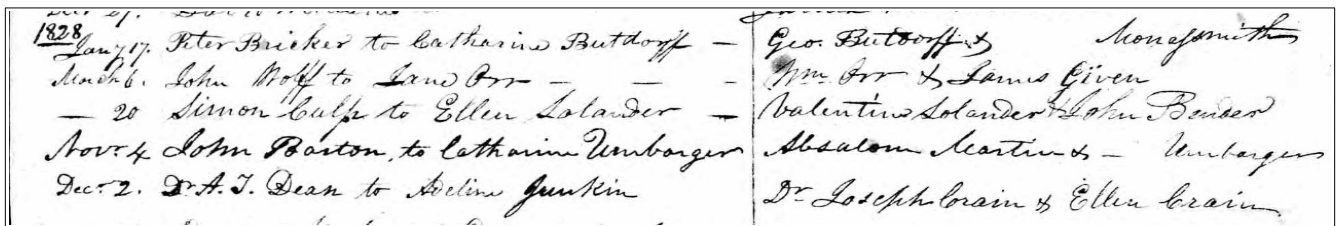

See <https://www.ancestry.com/search/collections/2451> image 72 (Pennsylvania and New Jersey, U.S., Church and Town Record, 1669-2013).

### 2.3 Children

#### 2.3.1 Rachel (1829-1903) & Simon Burgraff

Probably named after her grandmother Rachel Selanders. Married Simon Burgraff in Marion Co., OH, 1/9/1851. They had four children before Simon died in 1863. Rachel subsequently married Robert J. Bennett 9/24/1866 in Delaware Co., OH, after children are assigned (temporarily?) to Silas Cleveland as guardian in 1865. Rachel & Robert had at least one child before Robert died in 1870. By 1880,



## Simon Culp and Ellen Selanders of PA, OH, KS

Rachel and (5) children by both marriages are in Labette Co., KS. See

<https://familysearch.org/ark:/61903/1:1:MF5Q-3LR> .

Burgroff, John	7/24	Son	✓	✓	✓
Bennett Rachel	7/52	Mother	✓	✓	House Keeping
Burgroff Dora	7/26	Sister	✓	✓	✓
— Laura	7/17	Sister	✓	✓	✓
Bennett Ella	7/12	1/6 Sister	✓	✓	✓
— Alice	7/9	1/6 Sister	✓	✓	✓

### 2.3.2 Caroline (1831-1920) & Bennet Glaze

Caroline was born about 1832 in PA. See

<https://www.familysearch.org/tree/person/details/KVV8-HRF> for more detailed information.

She married Bennett/Benjamin? Glaze (1833-1890) in Marion Co., OH, 1/28/1855. They may have had nine children. In 1870 they are in Marlboro Twp, Delaware Co., OH, with six of the earliest children. Caroline died in Marion Co., OH, 11/21/1920. See

<https://familysearch.org/ark:/61903/1:1:X8GD-G5J> . At some point at least her husband was in Anderson Co, Kansas, since that is where he died 5/9/1890.



### 2.3.3 John Valentine (1835-1918) & Julia Delozier

See <https://www.familysearch.org/tree/person/details/LL9H-6PM> for more information. John's middle name was probably a tribute to his grandfather Valentine Selanders. John was in the Civil War. (4th Regiment, Ohio Infantry (3 months, 1861) :Ancestry.com. *U.S., Veterans Administration Master Index, 1917-1940* [database on-line]. Lehi, UT, USA: Ancestry.com Operations, Inc., 2019. ) He seems to have relocated to KS, where he married Julia Ann Delozier (2/8/1874) from MO. They may have had five children, and they farmed in OK. See for example <https://familysearch.org/ark:/61903/1:1:ML75-TP8> . He was buried in Rogers Co, OK, in 1918.

### 2.3.4 Malinda (1838-1920) & William Powell

Perhaps named after her Aunt Malinda Selanders. Malinda married William Powell in Marion Co., OH, 4/8/1855. They had 8 children. - In 1870 they were in Anderson Co., KS, however, later in that decade they were in Delaware Co., OH. The 1870 census (<https://familysearch.org/ark:/61903/1:1:MCJX-T11>) may also show that they were accompanied by brother John Culp. The 1880 census shows them

## Simon Culp and Ellen Selanders of PA, OH, KS

back in Delaware Co., OH - <https://familysearch.org/ark:/61903/1:1:M8MW-XZ6> . Ultimately, Malinda was buried in Marion Co., OH, 4/24/1920 -

<https://www.findagrave.com/memorial/31153688/malinda-powell> .

Here is an obit that has much relevant info about Malinda & her mother Ellen.



Not many of our readers are aware that Mrs. Malinda Powell who resides four miles west of Richwood, is a distant relative of Robert Bruce King of Scotland, but this is a fact. In the above illustration which was made from a photograph taken by W. A. Biddle of Richwood, during the fall of 1903, may be seen Mrs. Eleanor Selanders Culp, mother of Mrs. Powell. Mrs. Culp, who died the same year the photo was taken at the age of 97 years, was the great great granddaughter of Robert Bruce. She is the oldest of the group representing the five generations. She was born in Cumberland county, Penn., June 22, 1806. She was married to Simon Culp, March 16, 1827, and they had several children the fourth of which is Mrs. Malinda Culp Powell. Mrs. Powell was born in Marion county, Ohio, March 6, 1838, and was married to William Powell. They had ten children, the second of which is Mrs. Florence Powell McPherson. The next youngest in the illustration is Mrs. Maggie Malinda Hildreth, now the wife of James Hildreth. She was born near Prospect, Dec. 31, 1878, where she now resides. Eva May Hildreth is of the fifth generation. She is a very pretty little girl of three sum-

mers. Besides being the mother of seven children, Mrs. Culp has 53 grand children, and 60 great grand children, and four great great grandchildren. She resided in Kansas for a number of years, her husband dying there at the age of 90 years. She came all alone to Richwood, where she continued to reside with her daughter, Mrs. Powell. Mrs. Culp was always a great Christian worker and loved to read the daily papers and was well posted on current events of the day. Mrs. Powell and her husband moved to this vicinity about thirteen years ago from Marion county. They lived for years on the west bank of the Scioto river a short distance southwest of Prospect at Powell's mill. Mr. Powell erected the dam across the Scioto and built the mill at which place he sawed lumber and ground feed for the farmers in that vicinity for years. After they sold their farm and mill on the Scioto they moved on the farm on which Mrs. Powell now resides, four miles west of Richwood. Mrs. Powell said to the Gazette a few days ago that when they left the Scioto river they greatly missed the roar of the dam and for a time were exceedingly lonesome and homesick.

## Simon Culp and Ellen Selanders of PA, OH, KS

### 2.3.5 Margaret (1839-1890) & William Patton

Margaret was born in Delaware Co., OH, 8/20/1839) and married William Harrison Patton in Marion Co., OH, 10/28/1865. They had four children. At the time of the 1870 census, they were in Franklin Co., KS. (<https://familysearch.org/ark:/61903/1:1:MCJ2-F2K> ) They were still in KS at the time of the 1880 census. (<https://familysearch.org/ark:/61903/1:1:MFPN-PDK> ) She was buried in Anderson Co., KS, Kansas 4/2/1890. (<https://www.findagrave.com/memorial/89899457/margaret-r-patton> )

### 2.3.6 Mary Jane (1844-1893) & Philip Weiser

Mary Jane was born in Marion Co., OH, 11/24/1844. She married Philip Weiser (1845-1899) in Marion Co. 4/21/1866. They had eleven children and stayed in OH, unlike many of her siblings. Mary Jane was buried in Waldo, Marion Co., OH, 2/15/1893 (Wyatt Cemetery). (<https://www.findagrave.com/memorial/35175519/mary-jane-weiser> )

## 2.4 Census Records

### 2.4.1 1830 (PA - Silver Spring Twp, Cumberland Co., PA)

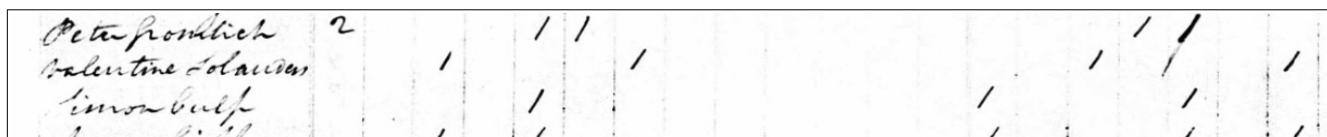

Year: 1830; Census Place: Silver Spring, Cumberland, Pennsylvania; Series: M19; Roll: 150; Page: 99; Family History Library Film: 0020624 (image 15)

Notice that the Selanders family is right next to that of Simon Culp!

See . . . "United States Census, 1830," database with images, *FamilySearch*

(<https://familysearch.org/ark:/61903/1:1:XHPR-J7Y> : 20 February 2021), Simon Culp, Silver Spring, Cumberland, Pennsylvania, United States; citing 99, NARA microfilm publication M19, (Washington D.C.: National Archives and Records Administration, n.d.), roll 150; FHL microfilm 20,624.

### 2.4.2 1840 (OH)

I believe that this is the family in Marlborough Twp, Delaware Co., OH. See "United States Census, 1840," database with images, *FamilySearch* (<https://www.familysearch.org/ark:/61903/1:1:XHYV-Z94> : 30 September 2021), Simon Culp, Delaware, Ohio, United States; citing p. 252, NARA microfilm publication , (Washington D.C.: National Archives and Records Administration, n.d.), roll ; FHL microfilm .

# Simon Culp and Ellen Selanders of PA, OH, KS

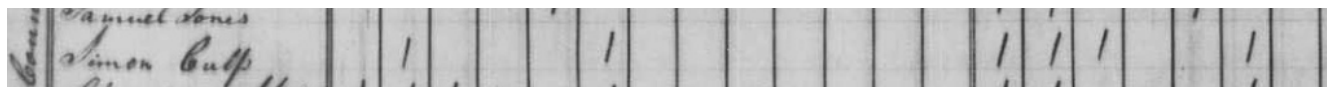

The right number of people with the right ages are present.

Note: The fact that this record is associated with Delaware Co. is not surprising. The county boundaries between Marion & Delaware Counties changed in about 1848. Among other things, parts of Marlborough Twp in Delaware Co. became part of Marion County. Morrow Co. was also formed from parts of both counties. See <https://www.mapofus.org/iframe/oh-maps.htm>. On left below is the 1840 situation. 1850 is on the right.

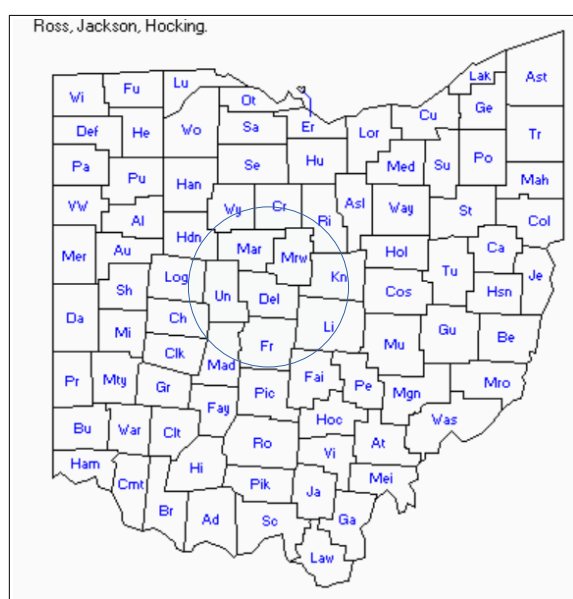
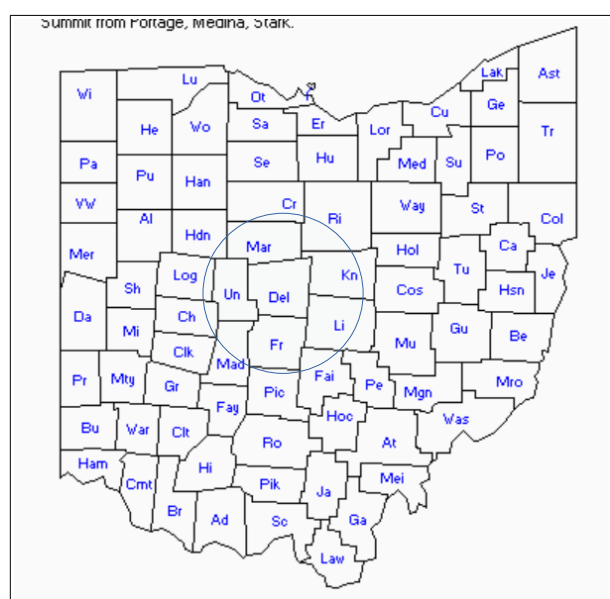

## 2.4.3 1850 (OH)

See "United States Census, 1850," database with images, *FamilySearch* (<https://www.familysearch.org/ark:/61903/1:1:MXQL-MKH> : 21 December 2020), Simon Culp, Waldo, Marion, Ohio, United States; citing family , NARA microfilm publication (Washington, D.C.: National Archives and Records Administration, n.d.).

## Simon Culp and Ellen Selanders of PA, OH, KS

Simon Culp	19 M	Farmer	300	Pa	1
Ellen	19 F			Pa	
Rachel	21 F			Pa	
Caroline	18 F			Pa	
Valentine	15 M			Pa	1
Melinda	13 F			O	1
Margaret	9 F			O	1
Mary	4 F			O	
Spencer Munch	22 M	Carpenter		Pa	

### 2.4.4 1860 (OH)

The 1860 census shows them in Delaware County, OH. See "United States Census, 1860", database with images, FamilySearch (<https://familysearch.org/ark:/61903/1:1:MCL2-XMT> : 18 February 2021), Simon Culp, 1860. They are living next to William Glaze, perhaps a relative of their son in law, Bennet/Benjamin Glaze, who is living nearby with their daughter Caroline. See <https://familysearch.org/ark:/61903/1:1:M6KY-CBW> .

952	960	Simon Culp	62 M	Farmer	✓	600	"		
		Ellen	54 F				"		
		Margaret	19 F				O		
		Mary	13 F				"		1
955	969	Wm Glaze	30 M	Carpenter	✓	300	100	"	
		Elizabeth	21 F					"	
		John	3 M					"	
		George	1 M					"	
		Elizabeth Rhodes	9 F					"	

### 2.4.5 1870 (OH)

The 1870 census (<https://familysearch.org/ark:/61903/1:1:M6L3-N9K> ) shows Ellen (b.1809) and Simon (b. 1803) with one John Glaze (b.1849), a relative of Simon by marriage of daughter Caroline into the Glaze family. They are in Waldo Twp, Marion Co., OH.



# Simon Culp and Ellen Selanders of PA, OH, KS

## 3 Other Culp Families in OH

In this section I investigate the other families/people with the surname Culp who appear in the OH census records in and near Marion Co., OH, from 1850-1880. The goal is to find candidates who might be related to Simon Culp. At a first glance it appears to me that Andrew and Samuel are good candidates to be brothers or cousins to Simon Culp (above).

### 3.1 Andrew Culp (1809-1890)

Andrew is sometimes identified as Andrew Z. Culp. At least one researcher claims that Andrew is a brother to the Simon Culp who appears in the 1850 OH census in Waldo Twp. See <https://www.familysearch.org/tree/person/details/L2RK-GT9> .

#### 3.1.1 Birth (1809 - PA)

The findagrave entry for Andrew indicates a birth date of 4/13/1809 in PA. See <https://www.findagrave.com/memorial/34111069/andrew-z-culp> .

#### 3.1.2 Census Records and Marriage(s)

##### 3.1.2.1 First Marriage (1830-33) to Leah Beam

Andrew married Leah Beam according to other researchers. The marriage to Leah must have taken place in PA some time around 1830-3, but I have not seen a record of the event.

##### 3.1.2.2 1840 census (PA)

See "United States Census, 1840," database with images, *FamilySearch* (<https://www.familysearch.org/ark:/61903/1:1:XHRT-V4Z> : 8 December 2020), Andrew Culp, Peters Township, Franklin, Pennsylvania, United States; citing p. 318, NARA microfilm publication , (Washington D.C.: National Archives and Records Administration, n.d.), roll ; FHL microfilm . This indicates that they had four children at the time. One male (in his 20s) is also present. Perhaps this is a brother of Andrew or Leah – or a farm hand.

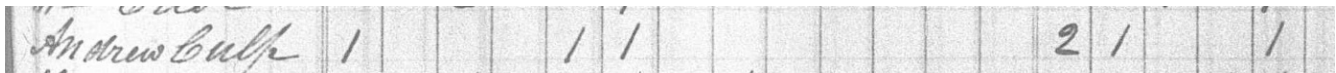

##### 3.1.2.3 1850 census (PA)

See <https://familysearch.org/ark:/61903/1:1:M4HX-61B> . They are in Montgomery Twp, Franklin Co., PA.

## Simon Culp and Ellen Selanders of PA, OH, KS

7		Mary B	2	"					
8	363	394	Andrew Culp	41	M		Hammer		
9			Leah	35	f				
10			Katharine S	15	f				
11			Francis	14	f				
12			Mary B	11	M				
13			Mariah	9	f				1
14			Samuel	5	M				1
15			Andrew S	3	M				1

### 3.1.2.4 1860 census (OH)

"United States Census, 1860", database with images, *FamilySearch* (<https://familysearch.org/ark:/61903/1:1:MCGN-K4L> : 18 February 2021), Lelhil Culp in entry for Andrew Culp, 1860. And <https://www.familysearch.org/ark:/61903/1:1:MCGN-K42> . The scribe did not get Leah's name right on the form, and the transcriber misinterpreted Andrew's age, which should be interpreted as 52 at the time of the census. They are living next to the family of Mary (b.1806) and Henry (b.1800) Strine, all from PA. This surname is mentioned elsewhere in this document and in the separate one about the descendants of Christian Selanders. Both families were recent immigrants to OH based on birth dates of their children, and the ages of the parents are quite similar.

7	Andrew Culp	39	M	Hammer	1,400	400	Hammer		
	Lelhil	45	f				00		
	John	21	M	Hammer			00		1
	Simon	13	M				00		1
	George	9	M				00		1
	Sarah	7	f				00		1

### 3.1.2.5 1870 Census (OH)

Leah dies in about 1870, and Andrew marries a second time. Second wife = Sarah Ebersole Bradford m.1871 (1830-1912).

Here is Andrew with his two youngest children in 1870 in Union Co., OH, before the second marriage. See <https://familysearch.org/ark:/61903/1:1:M6L1-WZD> .



## Simon Culp and Ellen Selanders of PA, OH, KS

138	Culp Andrew	61	M	W	Farmer	4000	61	Pennsylvania					
	George	19	M	W	Works on Farm			Pennsylvania					
	Sarah	16	F	W	Keeps house			Pennsylvania					

### 3.1.2.6 Second Marriage (1871) to Sarah Bradford

The second marriage took place in Hancock Co., OH. See "Ohio, County Marriages, 1789-2016", database with images, *FamilySearch* (<https://www.familysearch.org/ark:/61903/1:1:X8FC-XD3> : 29 September 2021), Andrew Culp and Sarah Bradford, 1871.

<p><b>GRANTED.</b> No 22 July 28<sup>th</sup> A. D. 1871</p> <p><b>MARRIAGE LICENSE</b></p> <p>Was this day granted to Andrew Culp and Sarah Bradford G. C. Baird Probate Judge.</p>	<p><b>AFFIDAVIT.</b></p> <p>STATE OF OHIO, } HANCOCK COUNTY, ss. }</p> <p>Personally came _____ applying for LICENSE for _____ to be married to _____ who being sworn, says that the said _____ is over the age of twenty-one years, and is unmarried, that the said _____ is over the age of eighteen years, and is unmarried, resides in Hancock County, and that they are not nearer akin than first cousins, and he knows of no legal impediment to said marriage.</p> <p>Sworn to and subscribed before me, this _____ day of _____ A. D. 18____</p> <p>Probate Judge.</p>	<p><b>RETURN.</b></p> <p>STATE OF OHIO, } HANCOCK COUNTY, ss. }</p> <p>I Certify, that on the 5<sup>th</sup> day of July A. D. 1871 Andrew Culp and Sarah Bradford were legally joined in marriage by me, a Minister L. H. Dickey M. G.</p>
--	---	---

### 3.1.2.7 1880 Census (KS)

By the time of the 1880 census, Andrew is in Labette Co., KS. See <https://familysearch.org/ark:/61903/1:1:MF5Q-3M6> . Labette Co. is about 90 miles south of Anderson Co., where his probable brother Simon was living at the time.

## Simon Culp and Ellen Selanders of PA, OH, KS

87	Culp, Andrew	W	M	71		1	Farmer
	Sarah	W	F	51	Wife	1	Keeping house
	Bradford O.M.	W	M	18	Step-son	1	Works on farm

### 3.1.3 Death (1890 - KS)

Andrew (d.2/12/1890 with burial in Crawford Co., KS) . See . . .

<https://www.findagrave.com/memorial/34111069/andrew-z-culp> .

Sarah (7/15/1912 with burial in Michigan) [https://www.findagrave.com/memorial/41829208/sarah-bradford\\_culp](https://www.findagrave.com/memorial/41829208/sarah-bradford_culp) (lived near/with her daughter Susan Alta Bradford Maurer in MI after Andrew's death).

### 3.1.4 Children

Information about the children from the marriage with Leah Beam (1815-1870) follows.

#### 3.1.4.1 Catherine Sophia (1834-1909) & Michael Hoke

Catherine married Michael Hoke in PA some time before 1856, when their first child was born. They had five children according to <https://www.familysearch.org/tree/person/details/LWM9-DH4> . They made the trip to Labette Co., KS, which is where they are still living in 1900. See <https://familysearch.org/ark:/61903/1:1:MMTY-L1N> . She died there in 1909. See <https://www.findagrave.com/memorial/229873321/catherine-hoke> .

#### 3.1.4.2 Frances (1835-1919) & John Phillipy

Married late in life to Alva W Scofield in Livingston Co., MI, in May 1907. The record shows birth place of Franklin Co., PA, and names of parents. See Michigan Department of Community Health, Division of Vital Records and Health Statistics; Lansing, MI, USA; Michigan, Marriage Records, 1867-1952; Film: 92; Film Description: 1907 Ionia-1907 Montcalm .

Prior to that she was married to William Whitney. And prior to that she was married in PA to John Phillipy. The earliest marriage produced three children – two born in PA, one born in OH.

See <https://www.familysearch.org/tree/person/details/L2RJ-8RL> for more information.

Francis appears to have died in Morrow Co., OH, in 1919. See <https://familysearch.org/ark:/61903/1:1:QVN3-74TS> .

## Simon Culp and Ellen Selanders of PA, OH, KS

### 3.1.4.3 **John B. (1838-1928) & Catherine/Margaret Strine**

John (born 6/7/1838 in Franklyn Co., PA) married Catherine Strine in 1861 in Marion O., OH, probably from the same family noted above. See <https://www.familysearch.org/tree/person/details/LCRS-H36> for more information. He may have married Catherine's sister Margaret a few years later. By 1870, they are in Morrow Co., OH, apparently childless (except for children from Margaret's first marriage) and with many Phillipy neighbors. (See Frances above.)

### 3.1.4.4 **Mariah (1840-1920) & Jacob Smith**

Mariah married Jacob Smith in PA. They had eleven children, one in PA, the rest in Marion Co., OH. For information see <https://www.familysearch.org/tree/person/details/LR4H-FMX>. Jacob died in Marion Co., OH, in 1907, and Mariah died in 1920 in Carroll Co., TN, presumably near a child.

### 3.1.4.5 **Samuel (1842-1864)**

Some information for Samuel can be found at <https://www.familysearch.org/tree/person/details/L2RP-RPW>. There is an indication that Samuel was buried in Washington, DC, 2/9/1864, which makes me think that he was died during the Civil War.

Enlistment: See National Archives and Records Administration (NARA); Washington, D.C.; *Consolidated Lists of Civil War Draft Registration Records (Provost Marshal General's Bureau; Consolidated Enrollment Lists, 1863-1865)*; Record Group: 110, *Records of the Provost Marshal General's Bureau (Civil War)*; Collection Name: *Consolidated Enrollment Lists, 1863-1865 (Civil War Union Draft Records)*; NAI: 4213514; Archive Volume Number: 1 of 3.

	Detail	Source
Name:	Samuel Culp	
Birth Year:	abt 1842	
Place of Birth:	Pennsylvania	
Age on 1 July 1863:	21	
Race:	White	
Marital Status:	Unmarried (Single)	
Residence:	Waldo, Ohio	
Congressional District:	8th	
Class:	1	

Served in Washington, D.C., where he died of smallpox 2/9/1864 (just about three months after enlisting). Buried at Arlington Cemetery.

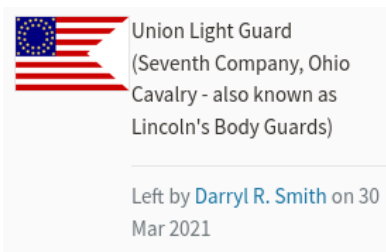

## Simon Culp and Ellen Selanders of PA, OH, KS

### 3.1.4.6 Andrew Simon Culp (1847-1922) & Mary Jane Boger (1848-1894)

For more complete information, see <https://www.familysearch.org/tree/person/details/LWM9-DBF> .

Born January, 1847 in PA. Young marriage in 1866 OK'd via note from Andrew. See <https://familysearch.org/ark:/61903/1:1:ZZPP-X8ZM> . Two children: Milton Monroe Culp (1871-1930) and Miles Dennis Culp (1879-1938).

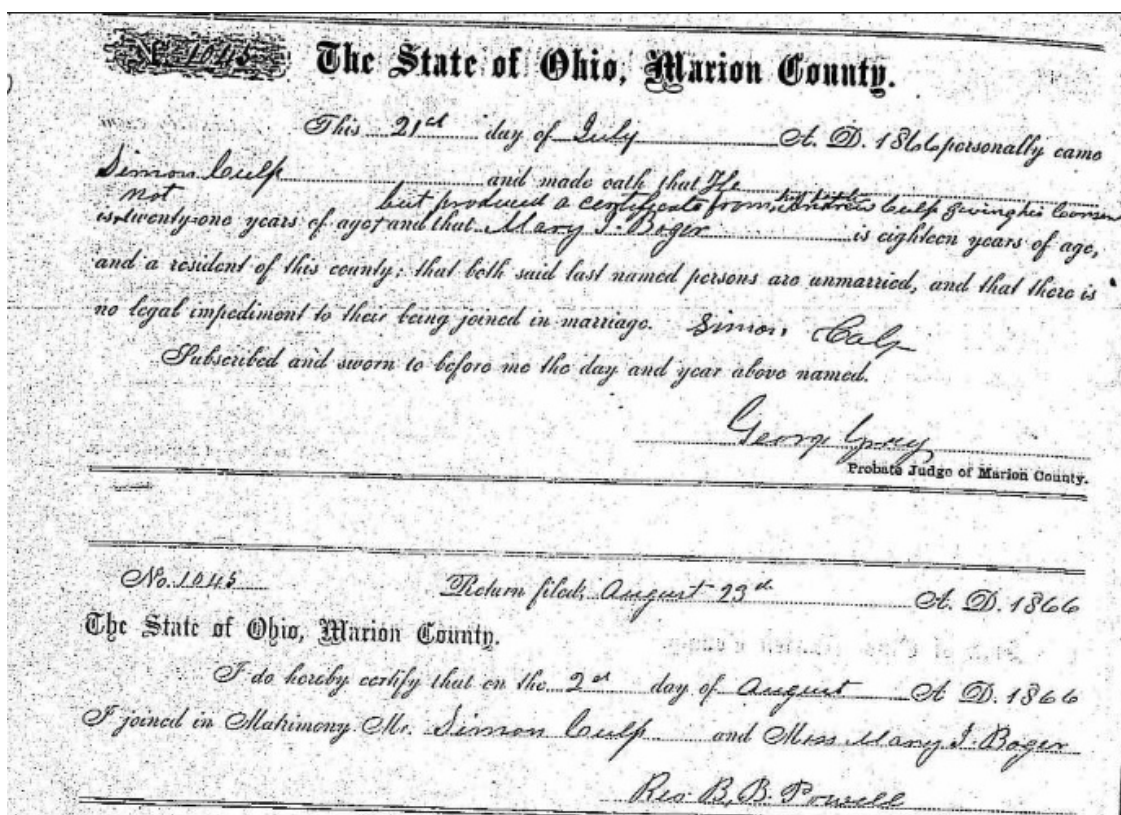

See <https://www.familysearch.org/tree/person/details/LWM9-DBF>

1870 census: "United States Census, 1870", database with images, FamilySearch (<https://www.familysearch.org/ark:/61903/1:1:M6L3-5BD> : 29 May 2021), A Simon Culp, 1870.

1880 Census: "United States Census, 1880," database with images, FamilySearch (<https://www.familysearch.org/ark:/61903/1:1:M89T-4RD> : 14 January 2022), Simon Culp, Waldo, Marion, Ohio, United States; citing enumeration district , sheet , NARA microfilm publication T9 (Washington, D.C.: National Archives and Records Administration, n.d.), FHL microfilm .

Buried in Warren Co., OH, 1922 - <https://www.findagrave.com/memorial/61663755/andrew-s-culp> .  
Death certificate here - <https://familysearch.org/ark:/61903/1:1:X85X-B46> . Signed by son Milton M.

## Simon Culp and Ellen Selanders of PA, OH, KS

Mary Jane was buried in Marion Co., OH, in 1894. See <https://www.findagrave.com/memorial/198302174/mary-jane-culp> .

### **3.1.4.7 George (1851-1917) & Edna Algare/Algier/Elgar?**

Information about George is sparse at <https://www.familysearch.org/tree/person/details/L2RP-RTC> . Burial information (<https://www.findagrave.com/memorial/78483320/george-culp> ) indicates more specific information. George was born in PA. He was married in 1870 - "Ohio, County Marriages, 1789-2016", database with images, *FamilySearch* (<https://www.familysearch.org/ark:/61903/1:1:XZ66-TMN> : 29 September 2021), George Culp and Edna J. Algier, 1870. He and his wife had at least one child (Howard), and they seem to have lived in Delaware Co., OH.

### **3.1.4.8 Sarah Phonetta (1853-1932) & Edward Robinson**

See <https://www.familysearch.org/tree/person/details/LKGR-FRG> for more information. She was married in 1870 in Union Co., OH. In 1900 Sara and her family were in Wyandot Co., OH - <https://familysearch.org/ark:/61903/1:1:MMXT-4JR> . This shows that she has had four children, all of whom are still living at the time. In 1920 she was widowed and with a daughter in NY: "United States Census, 1920", database with images, *FamilySearch* (<https://www.familysearch.org/ark:/61903/1:1:MJL3-3XT> : 2 February 2021), Sarah P Robinson, 1920.

Her death date is estimated to be 1933 in Wyandot Co., OH. See <https://www.findagrave.com/memorial/209218013/sarah-p-robinson> .

# Simon Culp and Ellen Selanders of PA, OH, KS

## 3.2 Samuel Culp (1808-1881)

Remarkably, someone has provided a picture at familysearch. See . . . <https://www.familysearch.org/tree/person/details/KPW4-L9W>



### 3.2.1 Birth (1808-1809 - PA)

Samuel's birth year inferred from various indirect sources is 1808-1809, and the place is Pennsylvania. One person shows an exact date of 12/15/1808, another asserts 12/15/1809.

### 3.2.2 Marriage (1840? - MD)

Some time around 1840 Samuel marries Mary/Maria (Smith?) who was born in MD. She was about 13 years younger than he. The marriage date of 1840 is based on the age of their first child, Andrew. One entry at ancestry.com shows quite a bit of information about Mary: <https://www.ancestry.com/family-tree/person/tree/49332547/person/20204947560/facts> .

### 3.2.3 Census Enumerations

#### 3.2.3.1 1850 census (MD)

"United States Census, 1850," database with images, *FamilySearch* (<https://www.familysearch.org/ark:/61903/1:1:MD4L-22V> : 22 December 2020), Samuel Culp, Washington, Maryland, United States; citing family , NARA microfilm publication (Washington, D.C.: National Archives and Records Administration, n.d.). This shows Samuel with a young wife and children in Washington Co., MD. Washington Co. is just south of Franklin Co., PA, so he is probably within 30 miles of Andrew Culp. This is circumstantial evidence that the two men could have known each other, and perhaps they are related as brothers or cousins. (The name of Samuel's first child does not hurt this theory.)

337	Samuel Culp	41	ill.	Harriet	Pa	✓
	Ellen Culp	28	71		MD	
	Andrew Culp	8	ill.		MD	
	Ellen A. Culp	5	71		MD	
	Sam Culp	10	12		MD	

# Simon Culp and Ellen Selanders of PA, OH, KS

## 3.2.3.2 1860 census (OH)

Waldo Twp, Marion Co., OH: "United States Census, 1860", database with images, FamilySearch (<https://familysearch.org/ark:/61903/1:1:MCGN-KWP> : 18 February 2021), Samuel Culp, 1860.

Samuel Culp	51	M	Farmer	1500	360	Prussia	
Maria	39	F				Maryland	
Andrew	18	M	son			Ohio	1
May	15	F				Ohio	
Margaret	11	F				Ohio	
Leah	1	F				Ohio	

## 3.2.3.3 1870 census (OH)

Year: 1870; Census Place: Scioto, Delaware, Ohio; Roll: M593\_1196; Page: 483B

([https://www.ancestry.com/discoveryui-content/view/39605480:7163?tid=&pid=&queryId=79a96b926f5329d070615126ff63c3f1&\\_phsrc=iQl14&\\_phstart=successSource](https://www.ancestry.com/discoveryui-content/view/39605480:7163?tid=&pid=&queryId=79a96b926f5329d070615126ff63c3f1&_phsrc=iQl14&_phstart=successSource) )

This happens to be the same town/county in which George Culp (son of Andrew) lived.

Culp Samuel	62	M	Farmer	2500	450	Prussia	
Maria	48	F	Prussia			Maryland	
Margaret	15	F				Ohio	
Leah	11	F				Ohio	
Charles	6	M				Ohio	

## 3.2.3.4 1880 Census (IN)

This is probably the family in White Co., IN, in 1880. - "United States Census, 1880," database with images, FamilySearch (<https://www.familysearch.org/ark:/61903/1:1:MHSY-B1D> : 14 January 2022), Samuel Cliep, Cass Township, White, Indiana, United States; citing enumeration district , sheet , NARA microfilm publication T9 (Washington, D.C.: National Archives and Records Administration, n.d.), FHL microfilm .

Culp Samuel	w	46	78	Farmer	
Mariah	w	54	Wife	Keeping House	
Margaret	w	22	Daughter		
Leah	w	21	Daughter		
Charles	w	16	Son	Farm laborer	

# Simon Culp and Ellen Selanders of PA, OH, KS

## 3.2.4 Children

### 3.2.4.1 **Andrew Sherman Culp (1842-1902) & Sarah Ann Mattix**

Son of Samuel Culp & Mariah Smith. See

<https://www.familysearch.org/tree/person/details/LH64-6XZ> . Andrew S. was in White Co., IN. in 1880: <https://familysearch.org/ark:/61903/1:1:MHSB-739> .

There is a very interesting/revealing life history article at family search. -

“The Gospel Messenger 04-12-1902 p 238

Death of Elder Andrew S. Culp.

Eld. A. S. Culp died at his home near Auburn, Nemaha Co., Nebr., Feb. 16, 1902. Pneumonia and heart trouble ended his life at the age of fifty-nine years, nine months and fifteen days. He was born in Washington County, Maryland, May 1, 1842. He moved from there in 1854. Married Sarah A. Mattix, of White County, Ind , Dec. 18, 1865. A year later he went to Marion County, Ohio. He united with the Brethren church in 186g. He moved to the Monticello church, Ind-, in 1873. He was called to the ministry March, 1873, advanced to second degree in 1875. He was ordained elder in 1881, moved to Harrison County. Ind., in 1891, then to Kentucky as missionary in October, 1894. He served the Lord faithfully there until July 23, 1900, when the Good Spirit directed him to go to the little scattered flock in and around Glen Rock.

I shall never forget how glad we all were to have him and his wife, two sons, two daughters and their husbands, cast their lots with us. Such good, pious members as Brother and Sister Culp and their family (who are members) are helpful to any community and always in demand. But his stay with us was so transient. Oh, that he could have stayed with us longer! He was such a wise counselor, so kind and so energetic in the cause of the Master. The church had prospered under his care. We all felt as if we could not give him up, but were member the Lord giveth and the Lord taketh away, and blessed be his name, He knoweth all things and doeth all things well, and we must be submissive to God's will.

Bro. Culp leaves a sorrowing wife, four sons, two daughters, two sisters and one brother, a minister, to mourn their loss, but we know that our great loss is his eternal gain. Feb. 14 he was anointed with oil in the name of the Lord, thus complying with the last requirements we have recorded in God's perfect plan of salvation. Services at the Baptist Highland church, conducted by Bro. H H. Ross, our home minister. His remains were laid to rest in the cemetery near by the church, where he had preached his last sermon nearly two weeks before, Miriam A, Maxey. ”





## Simon Culp and Ellen Selanders of PA, OH, KS

### 3.2.4.2 *Mary (1844-1914) & Adam Boger*

Mary was born in 1844 in MD according to <https://www.familysearch.org/tree/person/details/LH64-DT6> . She married in 1866 in Morrow Co., OH, to Adam Boger (Boyer?). In 1870 they were in Delaware Co., OH, with one child named Samuel. See "United States Census, 1870", database with images, *FamilySearch* (<https://www.familysearch.org/ark:/61903/1:1:M6KY-N98> : 29 May 2021), Mary A Boger in entry for Adam Boger, 1870. By 1910, they were in White Co., IN. See "United States Census, 1910," database with images, *FamilySearch* (<https://familysearch.org/ark:/61903/1:1:MKRD-1PT> : accessed 10 March 2023), Mary A Boger in household of Adam Boger, Cass, White, Indiana, United States; citing enumeration district (ED) ED 208, sheet 5A, family 70, NARA microfilm publication T624 (Washington D.C.: National Archives and Records Administration, 1982), roll 389; FHL microfilm 1,374,402. . Adam died in 1914 and Mary in 1925. See <https://www.findagrave.com/memorial/228804208/mary-ann-boger> . She is buried in a cemetery not far from where her mother is buried.

### 3.2.4.3 *Ann (1849-1851?)*

It appears that Ann died as an infant in MD.

### 3.2.4.4 *Margaret (1857-1943) & John Mattix/William James*

Margaret was born 7/10/1857 in OH according to <https://www.familysearch.org/tree/person/sources/KF2Y-PP3> . Margaret married into the Mattix family (as did her brother Andrew above). The marriage was 4/20/1881 in White Co., IN, to John Mattix. However, John did not live long after that, and Margaret married William James on 6/6/1886 in White Co. Margaret had two children with John and two with William: Joseph Mattix, John Mattix, Ella James, Otta(?) James. Here she is in the 1900 census: <https://familysearch.org/ark:/61903/1:1:M99G-N6M> . She lived a long life and died in White Co., IN - <https://www.findagrave.com/memorial/67090787/margaret-james> .

### 3.2.4.5 *Leah (1859-1888)*

Leah has a fairly short life that started in OH and ended in IN. Here is her grave in White Co., IN. <https://www.findagrave.com/memorial/208694670/leah-s-culp>

### 3.2.4.6 *Charles E. (1863-1906) & Charlotte Gilbert*

See <https://www.familysearch.org/tree/person/details/LH64-6WD> . Born 12/7/1863 in Marion Co., OH. Charles was married in IL 6/10/1889 to Charlotte Gilbert.

1 Charles E. Culp	1 6. 6. Culp	1 26 years	1 Samuel Culp	1 Charlotte Gilbert	1 25 years	1 James Gilbert	1 26. 11. 1889	1 26. 11. 1889
2	2 Rev. George M. ...	2 wife	2 ...	2	2 Wife	2 Allen Gresh	2	2
3	3 Teacher	3 Ohio	3 Street	3 Mt. Morris	3 Ohio	3 Frisb	3	3

## Simon Culp and Ellen Selanders of PA, OH, KS

He and Charlotte had six children – all born in various places in OH. It seems that Charles was a minister. Here is the family in 1900 in Dayton, OH - <https://familysearch.org/ark:/61903/1:1:MM6W-SWM> .

Name	Relationship	Sex	Age	Birth Date	Birth Place	Occupation	Education	Other
Culp, Chas E.	Head	M	21	1864 35	Pa	0	0	minister
Lottie	Wife	F	21	1865 34	Pa	0	0	"Baker"
Howard G.	Son	M	7	1890 9	Pa	0	0	at school
Jas Ernest	Son	M	7	1892 7	Pa	0	0	
David N.	Son	M	7	1895 5	Pa	0	0	
Albert R.	Son	M	7	1897 3	Pa	0	0	
Mabel M.	Daughter	F	7	1900 3/2	Pa	0	0	labor.

Charles died in 1906, possibly of cancer. See "Ohio, County Death Records, 1840-2001," database with images, *FamilySearch* (<https://familysearch.org/ark:/61903/1:1:F62K-2J9> : 1 March 2021), Chas. E. Culp, 24 May 1906; citing Death, Dayton, Montgomery, Ohio, United States, source ID v 6 p 37, County courthouses, Ohio; FHL microfilm 1,030,828. Charlotte (and perhaps Charles as well) is buried in Dayton, OH: <https://www.findagrave.com/memorial/139339346/charlotte-culp> .

### 3.2.5 Death (1881 - IN)

One researcher asserts that he died 1/22/1881 in White Co., IN. (And his father is listed as Simon (1785-1860).) This is supported by the fact that wife Maria/Mariah was buried 9/21/1898 in White Co., Indiana. See <https://www.findagrave.com/memorial/29820014/mariah-dean-culp> . The headstone indicates that her birth was 12/30/1822.

# Simon Culp and Ellen Selanders of PA, OH, KS

## 3.3 Jacob Culp (b.~1829 in Baden)

Both he and his wife are from Baden/Wurtemberg. Probably not relevant to this search. Lived in Marion Twp.

1870 census: see "United States Census, 1870", database with images, *FamilySearch* (<https://www.familysearch.org/ark:/61903/1:1:M6LS-YXJ> : 29 May 2021), Jacob Culp, 1870.

## 3.4 Kate Culp (b.~1799 Baden)

Appears in the household of Christian Sager in the 1870 Marion Co., OH, census. Both are from Baden and somehow related – perhaps through a missing wife of Christian. See "United States Census, 1870", database with images, *FamilySearch* (<https://www.familysearch.org/ark:/61903/1:1:M6L3-6ZY> : 29 May 2021), Kate Culp in entry for Christian Sager, 1870.

## 3.5 Peter Culp (b.1791 PA) and Susannah Braucher (b.1798)

Apparently born in Bucks Co., PA, 4/2/1791. Son of Peter Kolb (b.1765 in Berks Co., PA). Lived in Pickaway, Co., OH. Original name was probably Kolb. I don't see a connection to the other Culp people described above (yet?).

- 1817 marriage: <https://familysearch.org/ark:/61903/1:1:XDPOQ-CHD>
- 1850 census: <https://familysearch.org/ark:/61903/1:1:MXQB-SQW>
- 1860 census: <https://familysearch.org/ark:/61903/1:1:MCGS-RZQ>
- 1864 death: See <https://www.findagrave.com/memorial/51286909/peter-culp> and <https://familysearch.org/ark:/61903/1:1:QVKG-LQZW>
- 1870 census: shows wife with daughter in Marion Co., OH. - <https://familysearch.org/ark:/61903/1:1:M6L3-K9L>
- 1871 death: wife - <https://www.findagrave.com/memorial/51287030/susannah-magdalene-culp>

Father . . . <https://www.findagrave.com/memorial/63271203/peter-kolb>; Grandfather . . . <https://www.findagrave.com/memorial/233038121/johann-conrad-kolb>

## 3.6 Anthony H. Culp (1814-1892) and Susanna Bixler (1821-1900)

These folks lived in Columbiana Co., OH. The reason that I mention them is that they had a son named Simon Culp, who lived in Elkhart Co., IN. See

<https://www.familysearch.org/tree/person/details/9NRC-B49> . Although they appear to have been from PA, they do not appear to be directly related to the Culp folks that I am researching.

# Simon Culp and Ellen Selanders of PA, OH, KS

## 4 Misc. Leads

### 4.1 DNA

DNA matches with my mother at more than one company have provided the final clues that convinced me that Catherine Snyder was a Culp descendant and very possibly might be a sister to the three Culp brothers (Simon, Andrew, and Samuel) whose families are described above. Catherine's birth date (est. to be in the mid 1790s) means that she was likely an older sister. Following are example matches that I have found to support this proposal.

The matches of significance are rather distant, and that is consistent with the distance back in time to the most recent common ancestors who are estimated to be named Culp based on conventional family tree research. Most of these matches that I believe are significant involve about 30 cM of autosomal DNA. Using the shared cM project tool at DNAPainter is instructive. See <https://dnainter.com/tools/sharedcmv4> with 30 cM entered.

Using this estimating tool, leads me to believe that the most likely relationship between my mother and the matching people presented here is approximately 4C1R, but you can see the range of possibilities in the chart that follows.

**Filter**  
Enter the total number of cM for your match here:  
    
or enter %  
Then any relationships that fit will stand out below  
[Click here for a shareable link to the cM amount above](#)

**Most distant common ancestors**  
Assuming no [pedigree collapse](#) or [endogamy](#), and that you're related in just one way, the **furthest** back you might need to go to find common ancestors for a match of 30cM is **8th-Great-Grandparent level** or generation 11 on your pedigree chart.  
*The connection could be closer. However, it could date much further back to beyond the genealogical timeframe.*

**Relationship probabilities (based on stats from [The DNA Geek](#))**  
New: [View these relationships in a tree](#)

<b>54%</b>	6C 6C1R 5C 6C2R 4C1R 5C1R 7C Half 3C2R 4C2R 5C2R 7C1R 3C3R 4C3R 5C3R 8C or more distant
<b>17%</b>	Half 3C 3C1R Half 2C2R 2C3R
<b>17%</b>	4C Half 3C1R 3C2R
<b>9%</b>	3C Half 2C1R 2C2R Half 1C3R
<b>3%</b>	Half 2C 2C1R Half 1C2R 1C3R

[Click on any relationship to view a histogram](#)  
[Read more about cousin relationships](#)

# Simon Culp and Ellen Selanders of PA, OH, KS

Click on any relationship to view a histogram  
Read more about cousin relationships

Culp? (1775+/-)										GGGG Aunt / Uncle			
Catherine Culp? (1795)										GGG Aunt / Uncle			
Susanna Snyder (1832)										Great-Great-Aunt / Uncle			
Sam Loy (1859)										Great-Aunt / Uncle			
Marian Loy (1900)										Parent			
Mother (1920)										Child			
Other Relationships										Other Relationships			
Half GG-Aunt / Uncle 203 103 - 284	Half 1C2R 125 16 - 269	Half Great-Aunt / Uncle 431 184 - 668	Half 2C1R 66 0 - 190	Half 1C1R 224 62 - 469	Half Aunt / Uncle 871 492 - 1315	Half Sibling 1759 1160 - 2436	Sibling 2613 1613 - 3488	1C 866 396 - 1397	2C 229 41 - 592	3C 73 0 - 234	4C 35 0 - 139	5C 25 0 - 117	6C2R 13 0 - 45
Half 3C1R 37 0 - 139	Half 2C1R 66 0 - 190	Half 1C1R 224 62 - 469	Half Niece / Nephew 871 492 - 1315	Niece / Nephew 1740 1201 - 2282	Child 3487 2376 - 3720	1C1R 433 102 - 980	2C1R 122 14 - 353	3C1R 48 0 - 192	4C1R 28 0 - 126	5C1R 21 0 - 80	7C 14 0 - 57		
Half 3C2R 27 0 - 78	Half 2C2R 48 0 - 144	Half 1C2R 125 16 - 269	Half Great-Niece / Nephew 431 184 - 668	Great-Niece / Nephew 850 330 - 1467	Grandchild 1754 984 - 2462	1C2R 221 33 - 471	2C2R 71 0 - 244	3C2R 36 0 - 166	4C2R 22 0 - 93	5C2R 18 0 - 65	7C1R 12 0 - 50		
Half 3C3R	Half 2C3R	Half 1C3R 60 0 - 120	Half GG-Niece / Nephew 208 103 - 284	Great-Great-Niece / Nephew 420 186 - 713	Great-Grandchild 887 485 - 1486	1C3R 117 25 - 238	2C3R 51 0 - 154	3C3R 27 0 - 98	4C3R 19 0 - 60	5C3R 13 0 - 30	8C 11 0 - 42		

Typical match that follows falls in this area.

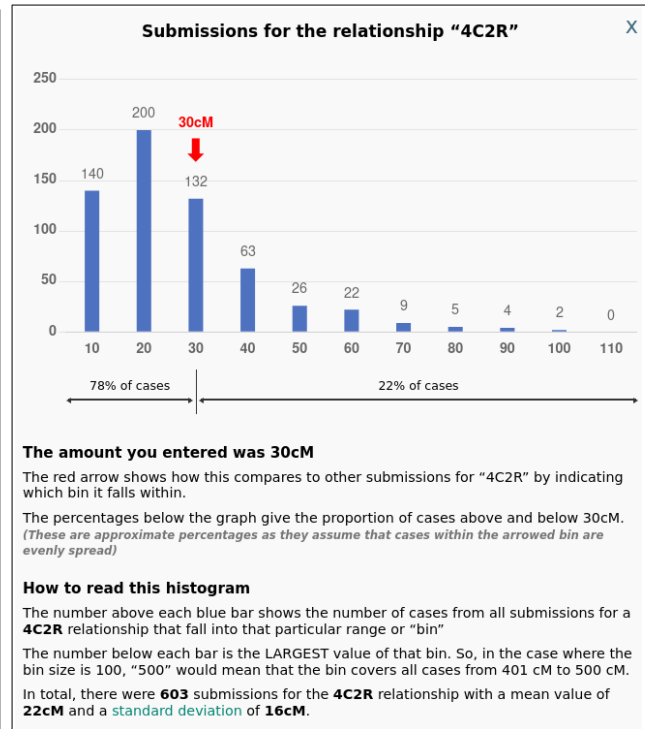
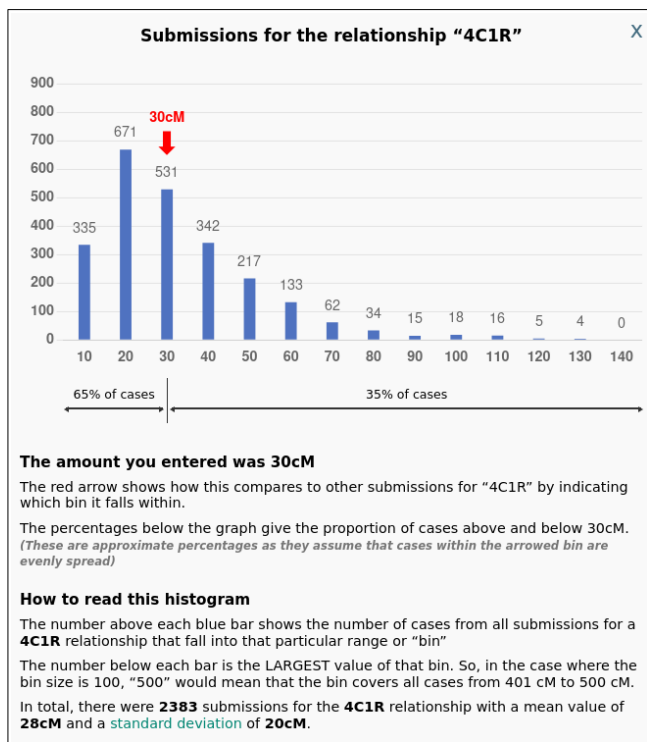

# Simon Culp and Ellen Selanders of PA, OH, KS

## 4.1.1 Example Ancestry.com Matches

These matches demonstrate connections to each Culp brother.

### 4.1.1.1 SK (Simon Culp descendant)\*

4th cousin 1x removed  
34 cM | < 1% shared DNA  
Maternal side ⓘ

Public linked tree  
500 People

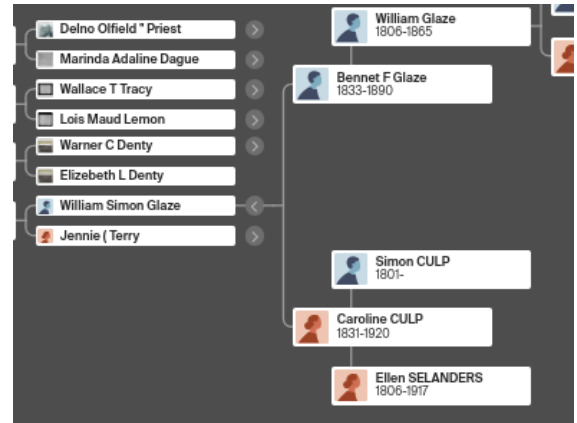

### 4.1.1.2 TS (Samuel Culp Descendant)\*

4th – 6th Cousin  
22 cM | < 1% shared DNA  
Parent 1's side

Public linked tree  
997 People

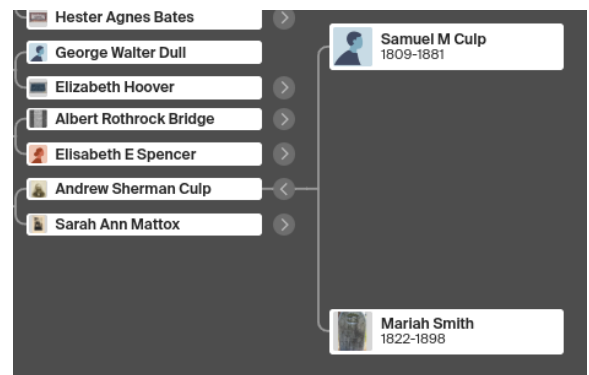

### 4.1.1.3 DC (Andrew Culp Descendant)\*

4th – 6th Cousin  
25 cM | < 1% shared DNA  
Parent 1's side

Public linked tree  
2,749 People

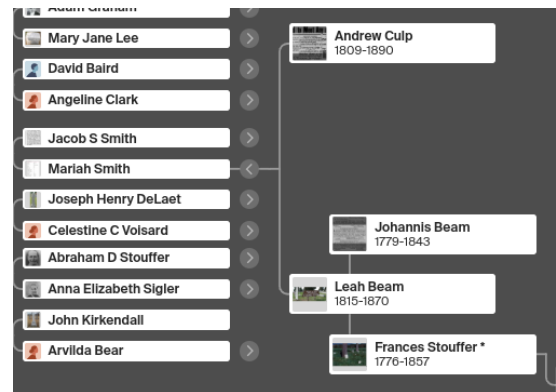

# Simon Culp and Ellen Selanders of PA, OH, KS

## 4.1.2 Example 23andme Matches

These are matches without trees. They just list surnames that include Culp. They must be contacted to see if they have trees. This was done in mid-March, 2023.

### 4.1.2.1 SH

4th Cousin (31 cM)  
0.42% DNA shared, 1 segments

---

### 4.1.2.2 MC\*

4th Cousin (25 cM)  
0.34% DNA shared, 1 segments

---

### 4.1.2.3 HW\*

4th Cousin (25 cM)  
0.33% DNA shared, 2 segments  
Invitation sent

# Simon Culp and Ellen Selanders of PA, OH, KS

## 4.1.3 Example familytreedna Matches

### 4.1.3.1 TS (Samuel Culp descendant)\*

This person is found at ancestry.com as well.

Ancestral Surnames | [View Details](#)

Bridge, Culp, Gilbert, Hart, Harlow, Jones,  
Phillips, Strickland, Zimmerman

Haplogroup

Y-DNA:  R-FTC3...  
mtDNA:  N/A

Relationship Range

3rd Cousin - 5th Cousin  
[Link on Family Tree](#)

Shared DNA

27 cM

Longest Block

27 cM

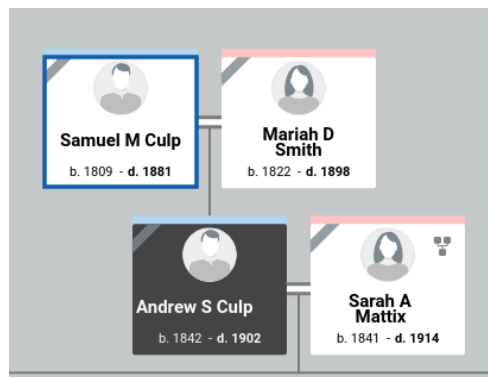



# Simon Culp and Ellen Selanders of PA, OH, KS

## 4.2 Pennsylvania Clues

So far, it has been established that William Selanders (b.1806) and Simon Culp (b.1801) lived near each other in Cumberland County, PA. Also, DNA evidence shows that there is a link between Simon Culp and his brothers and a descendant of Susanna Snyder. The most likely common link is one generation before that of Simon Culp and Catherine Snyder. In other words, my proposal is that Catherine and Simon were brother and sister, and less likely first cousins.

These facts regarding locational proximity and shared DNA make it possible to eliminate some research possibilities, and they point to the reasonableness of looking for evidence of the link between Simon Culp and Catherine Snyder. That means going back to PA records to try to establish relationships prior to migration of the families to OH. The following sections explore relevant PA evidence.

The analysis that follows in this section is based on proven associations and the one speculative baptismal record that may pertain to John Snyder. However, it is important to remember that some of what follows may in the end not be relevant to finding the ancestors of John and Catherine Snyder. It does, however, serve the purpose of defining some concrete proposals that could be confirmed or rejected as more research is done.

# Simon Culp and Ellen Selanders of PA, OH, KS

## 4.2.1 Intriguing Snyder Birth/Baptismal Record

Earlier in this document and in a separate document devoted to Selanders families, I have outlined the many important aspects of the Culp and Selanders families. Relationships among Snyder families are more numerous and difficult to research, however there is one intriguing birth/baptismal record that seems worth remembering. It may not be about the John Snyder of interest here, but it could be, and it is worth remembering because it points to a person of interest – Phillip Snyder – and a location – New Kingston in Silver Spring Twp, Cumberland Co., PA.

Name: Johan Jacob Snyder

Sex: Male

Christening Date: 29 Apr 1804

Christening Place: New Kingstown, Cumberland, Pennsylvania, United States

Christening Place (Original): Saint Stephen Evangelical Lutheran Church, New Kingstown, Cumberland, Pennsylvania, United States

Birth Date: 7 Jan 1804

Father's Name: Phillip Snyder

Father's Sex: Male

Event Type: Christening

Household	Role	Sex	Age	Birthplace
Phillip Snyder	Father	M		

Reference: Item 4

Digital Folder Number: 007717809

Microfilm Number: 496447

Originating System: ODM

Indexing Batch: C50482-1

Citing this Record

"Pennsylvania Births and Christenings, 1709-1950", database, *FamilySearch*

(<https://familysearch.org/ark:/61903/1:1:V2NP-3HV> : 15 February 2020), Johan Jacob Snyder, 1804.

## 4.2.2 Cumberland Co. PA Tax Records

Here is a summary of Cumberland County tax records from 1798 showing surnames and locales. The purpose is to show proximity of people with surnames of interest. Similar information for Franklin and York counties was considered, but this is the most interesting set of information since all three surnames of interest are present. The people that I expect to be present in these roles are the parents of John and Catherine Snyder, Simon Culp and his brothers, and William Selanders and his siblings (i.e., Christian Selanders).

# Simon Culp and Ellen Selanders of PA, OH, KS

The table shows 51 instances of tax record entries by locality (township) and taxed individual for people with the three surnames of interest.

From this table, I see the following locations of most interest because of the presence of multiple surnames of interest.

- Cumberland Co. (no twp identified)
- East Pennsboro Twp (Silver Spring Twp had not been separated at this time)
- Frankford Twp

These define areas where the families of interest may have interacted. Stars indicate people of interest. (Another researcher has suggested that Simon Culp's father was also named Simon.)

The source of the information is "All Pennsylvania, U.S., U.S. Direct Tax Lists, 1798" as provided at ancestry.com. This is also accessible with more difficulty as film # 008252652 at

Locality	Name	Count - County
(empty)	Anthony Snider	1
	Baltzer Snider	1
	Christ Sallander	1
	Conrad Snyder	2
	David Snider	1
	Henry Snyder	1
	Jacob Culp	1
	Philip Snider	1
21 Collection	Simon Culp	1
6th Division	David Snider	1
Allen	Conrad Snider	1
	Conrad Snyder	1
	Henry Snyder	1
Carlisle	George Snider	2
Cumberland	Myers Snyder	1
	Simon Kulp	1
East Pennsboro	Anthony Snider	1
	Jacob Culp	1
	Philip Snider	2
Frankford	Christy Snider	4
	Geo Snider	1
	Geo Snider Junior	1
	George Snider	3
	George Snider Junior	1
	Philip Snider	2
	Phillip Snider	2
	Simon Kulp	1
Greenwood	Myer Snyder	1
	Snyder and Myer Snyder	1
Leboyne	Nicholas Snider	1
Middleton	Chrisr Salinder	1
Mifflin	David Snider	1
Shippensburg	John Snyder	1
Tyrone	Henry Snider	1
	Peter Snider	1
	Philip Snider	1
Westpennsboro	Balsler Snider	1
	Baltren Snider	1
	Baltzer Snider	1
	David Snider	2
<b>Total Result</b>		<b>51</b>

<https://www.familysearch.org/ark:/61903/3:1:3Q9M-CSPR-1QRX-Z?i=3&cat=290639> .

# Simon Culp and Ellen Selanders of PA, OH, KS

## 4.2.3 Review of Census Records

### 4.2.3.1 1800-1820 Census Enumerations

If you assume that Simon Culp, John Snyder and the sons of Valentine Selanders were born in Cumberland Co., PA, then it might be possible to find their fathers in the 1800, 1810, and 1820 census enumeration.

#### 1800

In 1800, I find Christian Selanders (the elder) in Middleton Twp. This is probably the right family because Christian (the younger) is married in 1801 in Carlisle, which is juxtaposed next to Middleton Twp. See "United States Census, 1800," database with images, *FamilySearch* (<https://familysearch.org/ark:/61903/1:1:XHRD-P4N> : accessed 22 March 2023), Christr Sellander, Middleton, Cumberland, Pennsylvania, United States; citing p. 81, NARA microfilm publication M32, (Washington D.C.: National Archives and Records Administration, n.d.), roll 38; FHL microfilm 363,341. Christian, wife, 5 boys, and 3 girls.



Christian (elder) also appears in the 1800 list of “taxables.” See Ancestry.com. *Pennsylvania, U.S., Septennial Census, 1779-1863* [database on-line]. Provo, UT, USA: Ancestry.com Operations, Inc., 2012. - Original data:Septennial Census Returns, 1779–1863. Box 1026, microfilm, 14 rolls. Records of the House of Representatives. Records of the General Assembly, Record Group 7. Pennsylvania Historical and Museum Commission, Harrisburg, PA.

One Culp family is found in the 1800 census in Cumberland Co., PA. - the family of Simon Culp in Frankford Twp. Present are Simon (over 25 years old), his wife (over 25 years old), 2 boys, and 2 girls. See "United States Census, 1800," database with images, *FamilySearch* (<https://familysearch.org/ark:/61903/1:1:XHRD-GRT> : accessed 22 March 2023), Simon Culp, Frankford, Cumberland, Pennsylvania, United States; citing p. 103, NARA microfilm publication M32, (Washington D.C.: National Archives and Records Administration, n.d.), roll 38; FHL microfilm 363,341. (BTW, four other Culp families are found in Franklin Co., PA.- Those of Peter, Christopher, Mathias, and a second Christopher.)

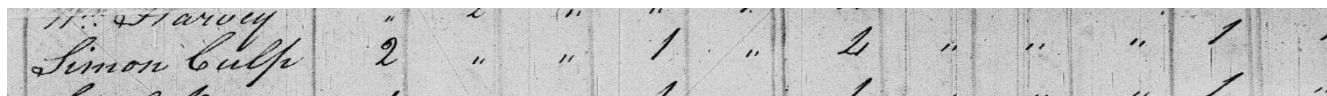

There are two Phillip Snyder families present in 1800 – one in Allen Twp and one in Frankfort Twp.

## Simon Culp and Ellen Selanders of PA, OH, KS

Here is the information about the Allen Twp Phillip. This looks like a young family to me – one small boy, 2 girls, Phillip and young wife. See "United States Census, 1800," database with images, *FamilySearch* (<https://familysearch.org/ark:/61903/1:1:XHRD-2CM> : accessed 22 March 2023), Phillip Snider, Allen, Cumberland, Pennsylvania, United States; citing p. 64, NARA microfilm publication M32, (Washington D.C.: National Archives and Records Administration, n.d.), roll 38; FHL microfilm 363,341.

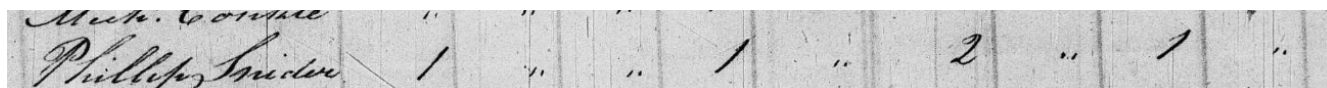

Here is the information about the other Phillip Snyder family in Frankford Twp. This is a much larger family – 2 boys, 6 girls, Phillip and wife! It is also the closer Snyder family to the Simon Culp family, but it is the farther one from the Christian Selanders family. See "United States Census, 1800," database with images, *FamilySearch* (<https://familysearch.org/ark:/61903/1:1:XHRD-GTC> : accessed 22 March 2023), Phillip Snider, Frankford, Cumberland, Pennsylvania, United States; citing p. 104, NARA microfilm publication M32, (Washington D.C.: National Archives and Records Administration, n.d.), roll 38; FHL microfilm 363,341.

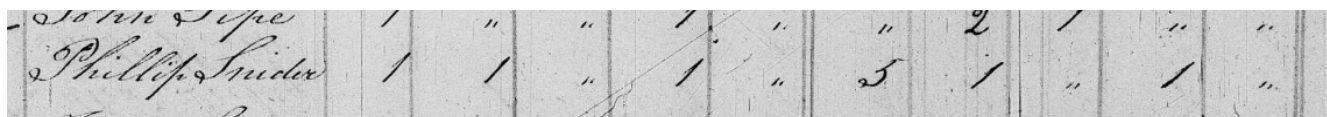

The Allen Twp family is closer to New Kingston, where John Jacob Snyder was born. See the intriguing baptismal record noted above. Whether either family is the true family into which the John Snyder who migrated to Marion Co., OH, is born in 1804 is yet to be proven.

## Simon Culp and Ellen Selanders of PA, OH, KS

### 1810

In 1810, both the elder and younger Christian Selanders were dead. However, brothers Francis and Valentine are reasonable targets.

Valentine's family is recorded here - "United States Census, 1810," database with images, *FamilySearch* (<https://familysearch.org/ark:/61903/3:1:33SQ-GYB4-VY6?cc=1803765&wc=QZZZ-9YS%3A1588180803%2C1588181502%2C1588181506> : 1 December 2015), Pennsylvania > Cumberland > East Pennsboro > image 3 of 10; citing NARA microfilm publication M252, (Washington D.C.: National Archives and Records Administration, n.d.).

Present are Valentine, his wife, 2 daughters, and one son.

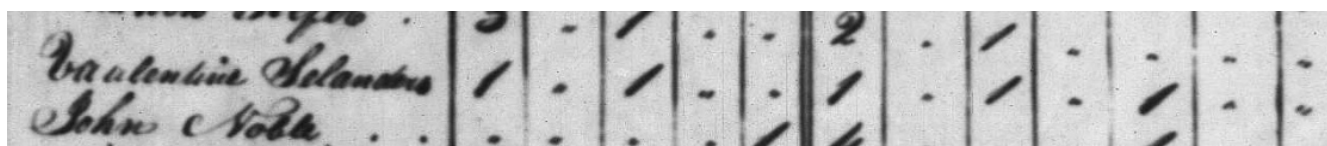

Francis did not marry until 11/29/1814. See . This may explain why I have not found him in the 1810 census. That is, he may not have had a residence of his own. See image 223 of . . . "Historical Society of Pennsylvania; Philadelphia, Pennsylvania; Historic Pennsylvania Church and Town Records; Reel: 401; Ancestry.com. Pennsylvania and New Jersey, U.S., Church and Town Records, 1669-2013 [database on-line]. Lehi, UT, USA: Ancestry.com Operations, Inc., 2011. ”.

Brally, Jane  
Married 29 Nov 1814 by Rev. R.  
Wilson, Francis Selander &  
Jane Brally

Next is Simon Culp (and the possible birth family of Simon, Samuel, Andrew, and Catherine(?)) -

In Mifflin Twp, Cumberland Co., PA, the follow was recorded. See image 79 . . . "United States Census, 1810", database with images, *FamilySearch* (ark:/61903/1:1:XH2K-TWV : Mon Mar 13 03:49:32 UTC 2023), Entry for Simon Culp, 1810. or Year: 1810; Census Place: Mifflin, Cumberland, Pennsylvania; Roll: 48; Page: 72; Image: Pam252\_48-0075; FHL Roll: 0193674 ; Ancestry.com. 1810 United States Federal Census [database on-line]. Lehi, UT, USA: Ancestry.com Operations, Inc., 2010. Images reproduced by FamilySearch.

## Simon Culp and Ellen Selanders of PA, OH, KS

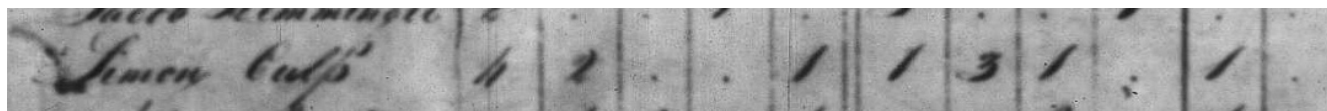

This is a really large family consisting of . . .

- Free White Persons - Males - Under 10: 4
- Free White Persons - Males - 10 thru 15: 2
- Free White Persons - Males - 45 and over: 1
- Free White Persons - Females - Under 10: 1
- Free White Persons - Females - 10 thru 15: 3
- Free White Persons - Females - 16 thru 25: 1
- Free White Persons - Females - 45 and over: 1

It would be very useful to know the names of all the children! One may be Simon (jr.) at age 9, and one may be an older sister Catherine at age about 15. This is all feasible, but unproven.

Phillip Snyder does not appear in the 1810 census in Cumberland Co. However, many other instances (12) of Phillip Snyder appear in PA. The most interesting one is that in Antrim Twp, Franklin Co., PA. This location is about 12 miles from where Andrew Culp was living a couple of decades later. BTW, it appears that this Phillip died later in 1810. His will indicates that he did have sons named Phillip and John.

See . . . "United States Census, 1810", database with images, *FamilySearch* (ark:/61903/1:1:XH27-63P : Mon Mar 20 13:12:45 UTC 2023), Entry for Philip Snyder, 1810. or "Year: 1810; Census Place: Antrim, Franklin, Pennsylvania; Roll: 54; Page: 865 1/2; Image: Pam252\_54-0262; FHL Roll: 0193680 Ancestry.com. 1810 United States Federal Census [database on-line]. Lehi, UT, USA: Ancestry.com Operations, Inc., 2010. Images reproduced by FamilySearch. "

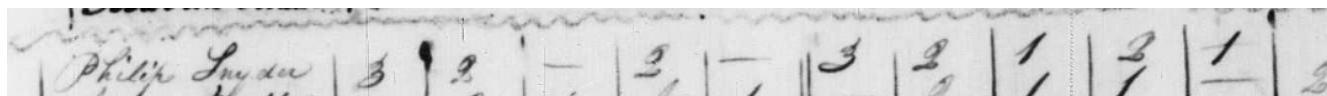

Again, this is a really large family consisting of . . .

- Free White Persons - Males - Under 10: 3
- Free White Persons - Males - 10 thru 15: 2

## Simon Culp and Ellen Selanders of PA, OH, KS

- Free White Persons - Males - 26 thru 44: 2
- Free White Persons - Females - Under 10: 3
- Free White Persons - Females - 10 thru 15: 2
- Free White Persons - Females - 16 thru 25: 1
- Free White Persons - Females - 26 thru 44: 2

Perhaps a 6 year old John Snyder is one of the children. (Speculation.) BTW, I do not find this family at this location in the 1800 census.

Here is a reference to Phillip's will - "Will Books, 1784-1905; Author: Franklin County (Pennsylvania). Register of Wills; Probate Place: Franklin, Pennsylvania Source Information Ancestry.com. Pennsylvania, U.S., Wills and Probate Records, 1683-1993 [database on-line]. Lehi, UT, USA: Ancestry.com Operations, Inc., 2015. "



# Simon Culp and Ellen Selanders of PA, OH, KS

**1820**

## Valentine Selanders

Probably this is Valentine & his family in Pennsboro Twp, Cumberland Co., PA. - "United States Census, 1820", database with images, *FamilySearch* (ark:/61903/1:1:XHL4-GGF : Tue Mar 14 23:09:54 UTC 2023), Entry for Valentine Slanders, 1820. or 1820 U S Census; Census Place: East Pennsboro, Cumberland, Pennsylvania; Page: 66; NARA Roll: M33\_102; Image: 28 ; Ancestry.com. 1820 United States Federal Census [database on-line]. Provo, UT, USA: Ancestry.com Operations, Inc., 2010. Images reproduced by FamilySearch.

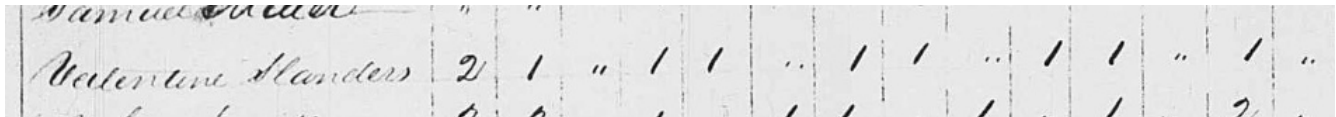

- Free White Persons - Males - Under 10: 2
- Free White Persons - Males - 10 thru 15: 1
- Free White Persons - Males - 16 thru 25: 1
- Free White Persons - Males - 26 thru 44: 1
- Free White Persons - Females - Under 10: 1
- Free White Persons - Females - 10 thru 15: 1
- Free White Persons - Females - 26 thru 44: 1
- Free White Persons - Females - 45 and over: 1

## Simon Culp

I have been unable to find a record for Simon Culp in the 1820 federal census in PA.

## Phillip Snyder

Likewise, I have been unable to find Phillip Snyder in the 1820 federal census in either Franklin or Cumberland Co. in PA.

# Simon Culp and Ellen Selanders of PA, OH, KS

## 4.2.3.2 1830 Census Enumerations

Since we know that Simon, John, and William were located close to each other in 1850 OH, perhaps they were also close together in 1830 PA, just before they migrated to OH. If that is the case, the 1830 census might reflect this. Each of these people is probably married by this date, so it makes sense to switch from looking for the families of their suspected parents to looking for their own families.

I believe that what follows strengthens the relationship between Simon Culp and Valentine Selanders, and it provides some interesting possibly useful facts to help identify John Snyder. However, the latter issue still requires more information – like a marriage record for John Snyder and Catherine (Culp?).

### Valentine Selanders

In the 1830 census in Silver Spring Twp, Cumberland Co., PA, Valentine's family is listed next to that of Simon Culp's (the younger Simon Culp).

See . . . *Year: 1830; Census Place: Silver Spring, Cumberland, Pennsylvania; Series: M19; Roll: 150; Page: 99; Family History Library Film: 0020624 Source Information Ancestry.com. 1830 United States Federal Census [database on-line]. Provo, UT, USA: Ancestry.com Operations, Inc., 2010. Images reproduced by FamilySearch. Or "United States Census, 1830," database with images, FamilySearch (<https://familysearch.org/ark:/61903/3:1:33SQ-GYBQ-9DH3?cc=1803958&wc=35YC-LL2%3A1588474703%2C1588471902%2C1588476504> : 14 August 2015), Pennsylvania > Cumberland > Silver Spring > image 15 of 22; citing NARA microfilm publication M19, (Washington D.C.: National Archives and Records Administration, n.d.).*

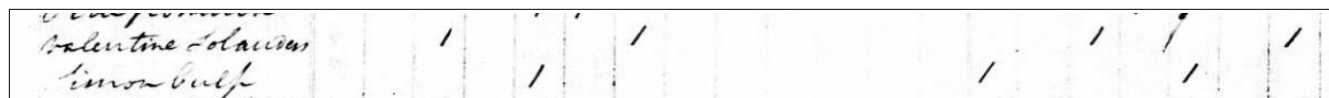

- Free White Persons - Males - 10 thru 14: 1
- Free White Persons - Males - 40 thru 49: 1
- Free White Persons - Females - 10 thru 14: 1
- Free White Persons - Females - 40 thru 49: 1

# Simon Culp and Ellen Selanders of PA, OH, KS

## Francis Selanders

Francis and family are in Allen Twp, Cumberland Co., PA. See . . . Year: 1830; Census Place: Allen, Cumberland, Pennsylvania; Series: M19; Roll: 150; Page: 103; Family History Library Film: 0020624; Ancestry.com. 1830 United States Federal Census [database on-line]. Provo, UT, USA: Ancestry.com Operations, Inc., 2010. Images reproduced by FamilySearch. Or "United States Census, 1830," database with images, *FamilySearch* (<https://familysearch.org/ark:/61903/3:1:33S7-9YBQ-9C69?cc=1803958&wc=35YC-LLJ%3A1588474703%2C1588471902%2C1588476505> : 14 August 2015), Pennsylvania > Cumberland > Allen > image 1 of 28; citing NARA microfilm publication M19, (Washington D.C.: National Archives and Records Administration, n.d.).

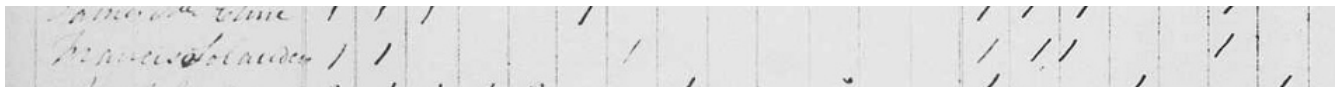

- Free White Persons - Males - Under 5: 1
- Free White Persons - Males - 5 thru 9: 1
- Free White Persons - Males - 40 thru 49: 1
- Free White Persons - Females - Under 5: 1
- Free White Persons - Females - 5 thru 9: 1
- Free White Persons - Females - 10 thru 14: 1
- Free White Persons - Females - 30 thru 39: 1

## Simon Culp

See the section above for Valentine Selander.

# Simon Culp and Ellen Selanders of PA, OH, KS

## John Snyder

There are no Snyder households shown in the 1830 census in Silver Spring Twp. However, there are numerous John Snyder household in other townships.

First, however, the same Phillip Snyder household that was found in 1810 in Franklin Co. seems to be present. See . . .

"United States Census, 1830," database with images, *FamilySearch*

(<https://familysearch.org/ark:/61903/1:1:XH57-2GG> : 20 February 2021), Philip Snider, Antrim, Franklin, Pennsylvania, United States; citing 382, NARA microfilm publication M19, (Washington D.C.: National Archives and Records Administration, n.d.), roll 151; FHL microfilm 20,625.

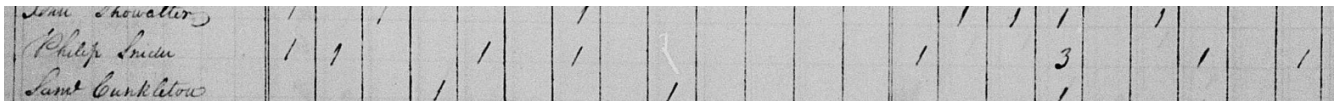

There is one male present who is the right age to be John Snyder. Perhaps he is unmarried at this point and living in his father's house.

Here is a list of the seven John Snyder households in Cumberland Co. where the head of household is in the right age range to possibly be the John Snyder that I have an interest in. None fit well.

Probably too old.	<b>John Snyder</b> United States Census, 1830	<b>Census</b> 1830 Allen, Cumberland, Pennsylvania, United States
Probably too old.	<b>John Snyder</b> United States Census, 1830	<b>Census</b> 1830 West Pennsboro Township, Cumberland, Pennsylvania, United States
Definitely too old.	<b>John Snyder</b> United States Census, 1830	<b>Census</b> 1830 Frankford Township, Cumberland, Pennsylvania, United States
Unlikely due to number of children: 1 boy, 2 girls, & older woman in 50s	<b>John Snyder</b> United States Census, 1830	<b>Census</b> 1830 Frankford Township, Cumberland, Pennsylvania, United States
Probably too old.	<b>John Snyder</b> United States Census, 1830	<b>Census</b> 1830 Newton Township, Cumberland, Pennsylvania, United States
Possible, but count of children suspect	<b>John Snyder</b> United States Census, 1830	<b>Census</b> 1830 Frankford Township, Cumberland, Pennsylvania, United States
Definitely too old.	<b>John Snyder</b> United States Census, 1830	<b>Census</b> 1830 South Middleton Township, Cumberland, Pennsylvania, United States

# Simon Culp and Ellen Selanders of PA, OH, KS

## 4.2.4 PA Church and Town Records

In this section, I present the results of a survey of information made available at ancestry.com of “*All Pennsylvania and New Jersey, U.S., Church and Town Records.*”

Here are the results of a search for records involving “Culp”.

([https://www.ancestry.com/search/collections/2451/?name=simon\\_culp&event=cumberland-pennsylvania-usa\\_789&birth=1805\\_cumberland-pennsylvania-usa\\_789&count=50&name\\_x=s](https://www.ancestry.com/search/collections/2451/?name=simon_culp&event=cumberland-pennsylvania-usa_789&birth=1805_cumberland-pennsylvania-usa_789&count=50&name_x=s))

There is just one “find” of interest – that being the record of the marriage of Simon Culp and Ellen Selanders. Note the location (Silver Spring Twp) and the presence of Ellen’s brother Valentine. I am not sure of the significance of the other witness named John Bender(?).

Name	Simon Culp
Event Type	Marriage
Marriage Date	20 Mar 1828
Marriage Place	Mechanicsburg, Cumberland, Pennsylvania, USA
Denomination	Presbyterian
Organization Name	Silver Spring Presbyterian Church
Spouse	Ellen Salander

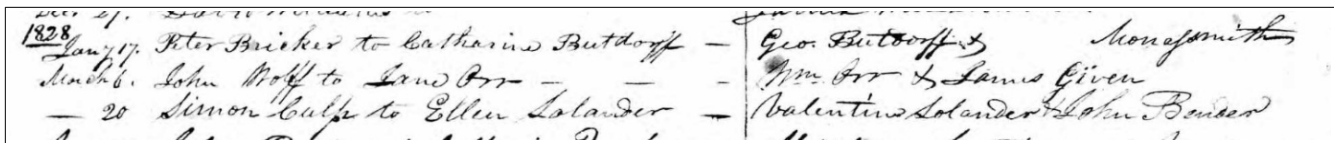

## Simon Culp and Ellen Selanders of PA, OH, KS

Running a similar query for “Selanders” entries centered on 1828 yields a list of 15 events as shown below.

First, note that all events took place in Cumberland County – usually Carlisle or Mechanicsburg, the two largest towns in eastern Cumberland Co.

There are multiple entries for the marriage of Christian to Elizabeth Wunderlick in 1801. The 1806 marriage of Elizabeth Selanders pertains to a sister of the Selanders brothers. The 1814 marriage of Francis Selanders to Jane Brally is recorded. There is the 1816 marriage of sister Catherine to James Mulhall. The 1826 marriage of Daniel Selanders pertains to a son of Christian. Ellen’s marriage in 1828 to Simon Culp is present. Valentine’s marriage is not present for some reason, but the 1832 baptism of a daughter (Rachel) is recorded. The 1843 entries for William Selander pertains to a child of Francis.

Christian Selander	Marriage	27 Oct 1801	Cumberland, Pennsylvania	Elizabeth	
William Selander	Marriage	9 Dec 1843	Cumberland, Pennsylvania	Lucetta	
Christian Selander	Marriage	27 Oct 1801	Carlisle, Cumberland, Pennsylvania	Elizabeth	
William Selander	Marriage	9 Dec 1843	Carlisle, Cumberland, Pennsylvania	Lucetta	
Christian Selander	Marriage	27 Oct 1801	Carlisle, Cumberland, Pennsylvania	Elizabeth	
Ellen Salander	Marriage	20 Mar 1828	Mechanicsburg, Cumberland, Pennsylvania	Simon	
Daniel Solanders	Marriage	21 Dec 1826	Cumberland, Pennsylvania	Mary	
Daniel Solanders	Marriage	21 Dec 1826	Carlisle, Cumberland, Pennsylvania	Mary	
Francis Solander	Marriage	29 Nov 1814	Carlisle, Cumberland, Pennsylvania	Jane	
Cath Solander	Marriage	22 Feb 1816	Mechanicsburg, Cumberland, Pennsylvania	James	
Elizabeth Salander	Marriage	4 Sep 1806	Carlisle, Cumberland, Pennsylvania	Frederick	
Catharine Solander	Marriage	22 Feb 1816	Cumberland, Pennsylvania	James	
Francis Solander	Marriage	29 Nov 1814	Mechanicsburg, Cumberland, Pennsylvania	Jane	
Mrs Elizabeth Salander	Marriage	4 Sep 1806	Carlisle, Cumberland, Pennsylvania	Frederick	
Francis Solander	Marriage	29 Nov 1814	Carlisle, Cumberland, Pennsylvania	Jane	
Rachel Solander	Baptism	13 Sep 1832	Mechanicsburg, Cumberland, Pennsylvania	Rachel	

## Simon Culp and Ellen Selanders of PA, OH, KS

Searching for events involving John Snyder centered within 5 years of 1827 yields the following list. This particular query was chosen because it spans a period of time between when John would have been about 18 and when his daughter Susanna was born.

The first two entries (for 1831) come from a Methodist attendance record in which a wife is not identified. The church is the Allison United Methodist Church.

Name	Event Type	Event Date	Event Place	Relatives
John L Snyder	Residence	23 Mar 1823	Carlisle, Cumberland, Pennsylvania	
John L Snyder	Residence	1823-1833	Carlisle, Cumberland, Pennsylvania	
John Snider	Marriage	7 Jun 1832	Cumberland, Pennsylvania	Mary
John Snider	Marriage	7 Jun 1832	Carlisle, Cumberland, Pennsylvania	Mary

The next two entries record a marriage in Carlisle to Mary Heyser/Huyser on 6/7/1832, both from Frankford Twp. It is not clear if this is a significant find.

Handwritten church record snippet showing a marriage entry for John Snider and Miss Mary Heyser. The text reads: "Snider, John Married 7 June 1832 by Rev. W. J. Ebaugh, John Snider to Miss Mary Heyser both of Frankford Twp".

Note: I have looked through a copy of the book entitled *Cumberland County Pennsylvania Church Records of the 18<sup>th</sup> Century*, by F. Edward Wright, ISBN 978-1-58549-279-4. There was nothing new in this reference, except for the following note that may help explain why records have been so sparse. (Remember that Silver Spring Twp is proven to be of special interest based on the 1830 census notes above.

“ Silver’s Spring

This congregation was also formed in 1734. No records of Silver’s Spring have survived for the 18<sup>th</sup> century.”

# Simon Culp and Ellen Selanders of PA, OH, KS

## 4.2.5 Pennsylvania Land Warrants & Applications

A quick search of this source at ancestry.com yielded the following. It is not clear how Mathias Culp might be related to Simon Culp. The mention of the Juniata River may be useful at some point.

**Name** Mathias Culp  
**Warrant Date** 8 Sep 1762  
**Warrant Place** Cumberland

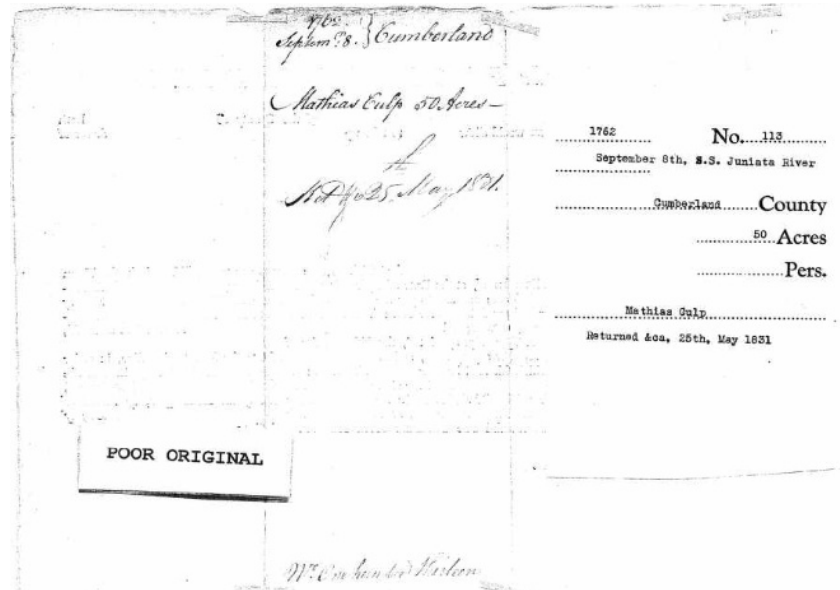

A similar search for early Snyder records yielded 620 records, 22 that were clearly for Cumberland Co. The given names associated with these 22 are . . . Christian, Frederick, Christopher, George, David, Ballser (Balthasar?), and Joshua. Right now I don't know how assess the significance of any of these.

Name	Warrant Date	Warrant Place
Christian Snyder	22 Apr 1762	Juniata, Cumberland
Frederick Snyder	31 May 1762	Tyrone, Cumberland
Frederick Snyder	10 Sep 1762	Troff Creek, Cumberland
Frederick Snyder	1 Jun 1763	Cumberland
Frederick Snyder	1 Jun 1763	Cumberland
Christian Snyder	1 Jun 1763	Cumberland
Christian Snyder	1 Jun 1763	Cumberland
Christian Snyder	23 Jul 1765	Raystown Branch of Juniata, Cumberland
Christopher Snyder	9 Mar 1787	Greenwood, Cumberland
George Snyder	5 May 1794	Cumberland
George Snyder	12 Jun 1794	Cumberland
David Snyder Esquire	26 Feb 1806	Frankford, Cumberland
Ballser Snyder	13 Feb 1767	Cumberland
David Snyder Esquire	26 Feb 1805	Cumberland
Christian Snyder	31 May 1762	Cumberland
Fredk Snyder	19 Sep 1762	Cumberland
Frederick Snider	10 Jul 1765	Near Raystown Creek, Cumberland
Joshua Snider	5 Jul 1834	South Middleton, Cumberland
Joshua Snider	5 Jul 1834	Dickinson, Cumberland
Christ Snider	9 Mar 1787	Cumberland
Joshua Snider	5 Jul 1834	Cumberland
Joshua Snider	5 Jul 1834	Cumberland
John Snyder	30 Nov 1820	Uleter, Bradford



# Simon Culp and Ellen Selanders of PA, OH, KS

## 4.2.6 Anabaptist Records

A quick review of the sources listed in the two following sections led to no new information. This may largely be due to the fact that records from these sources are quite sparse prior to about 1850.

Apparently, congregations purposely did not maintain records of the same quality as Lutheran and Catholic records due to a strong desire to be independent and less involved with an outside world that offered little more than taxation requirements. A person who knows more about such congregations can perhaps confirm/refute this impression of mine.

### 4.2.6.1 *Church of the Brethren Records*

See <https://www.cob-net.org/genchurch.htm>

### 4.2.6.2 *Mennonite Records*

See Mennonite Heritage Center of Eastern PA Our Immigrant Heritage - <https://mhcp.org/>

# Simon Culp and Ellen Selanders of PA, OH, KS

## 4.2.7 Possible Ancestors of Simon Culp (b. ~1801)

### 4.2.7.1 *Dielman Kolb (b. ~1648)*

Another researcher has suggested that Simon Culp may be descended from on Dielman Kolb, who came to North American in the early 1700s. His life and many descendants are documented in the following references from 1895 and 1922, respectively.

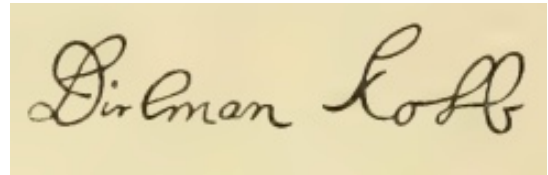

Kolb Families

[-https://openlibrary.org/books/OL7127870M/A\\_genealogical\\_history\\_of\\_the\\_Kolb\\_Kulp\\_or\\_Culp\\_family](https://openlibrary.org/books/OL7127870M/A_genealogical_history_of_the_Kolb_Kulp_or_Culp_family)

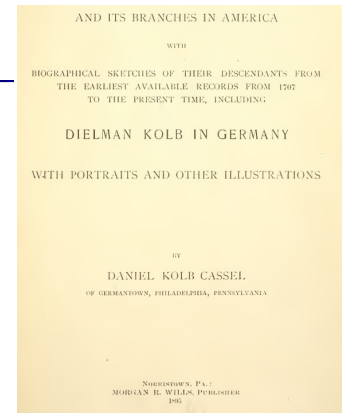

Strassburger Families -

[https://openlibrary.org/authors/OL359158A/Ralph Beaver Strassburger](https://openlibrary.org/authors/OL359158A/Ralph_Beaver_Strassburger)

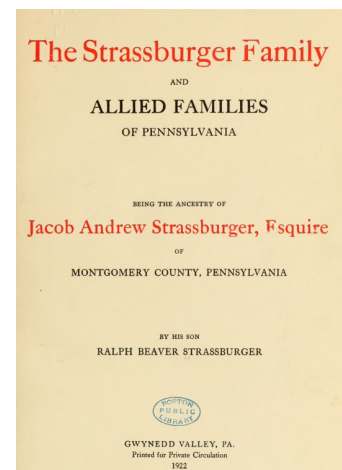

# Simon Culp and Ellen Selanders of PA, OH, KS

Another more recent reference for these Kolb families is the tree shown here . . .

<https://www.familysearch.org/tree/pedigree/landscape/LHM9-84R>

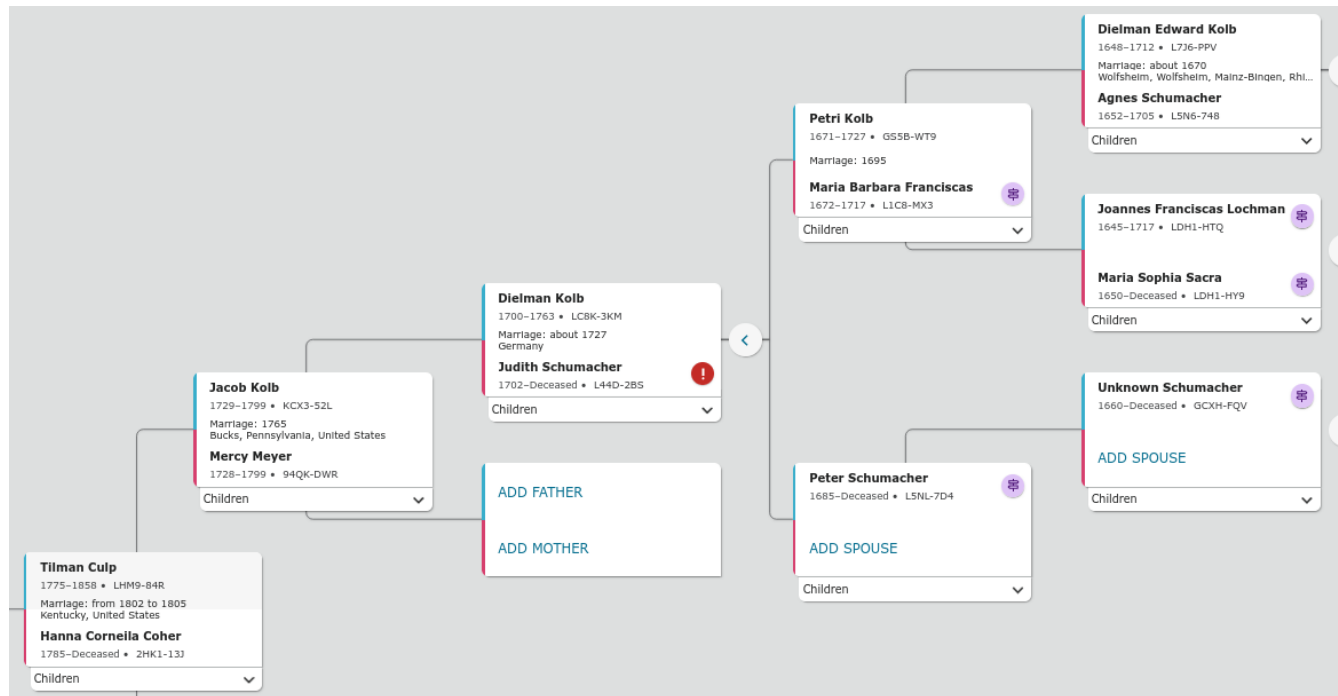

A summary of the family of Dielman and his wife Agnes follows.

- Dielman Culp (1648-1712) m. Agnes Schumacher (1652-1705); immigrated 1707; see <https://www.findagrave.com/memorial/76790405/dielman-kolb> ; possible children follow
  - Rev. Peter Culp (1671-1727): died before migration to North America
  - Agnes (1672-1751): died before migration to North America
  - Ann Culp (1676-1738): married another Culp? ; died before migration to North America
  - Heinrich Schumaker Kolb (1679-1730): see <https://www.findagrave.com/memorial/13981280/heinrich-schumaker-kolb>
  - Rev Martin Culp (1680-1761): see see <https://www.findagrave.com/memorial/40100227/martin-kolb>
  - Bishop Henry Culp (1682-1730)
  - Johannes Kolb (1683-1759): see <https://www.findagrave.com/memorial/138570391/johannes-kolb>
  - Deacon Jacob Culp (1685-1739): see <https://www.findagrave.com/memorial/28168487/jacob-kolb>
  - Rev Dielman Culp (1691-1756): see <https://www.findagrave.com/memorial/77705267/dielman-kolb>; Lower Salford Mennonite Cemetery, Harleysville, Montgomery County, Pennsylvania, USA

# Simon Culp and Ellen Selanders of PA, OH, KS

This record may show the arrival of the eldest son of Dielman Kolb, but it could also pertain to another person with the same name.

It appears that Dielman and his wife spent their lives in the vicinity of Montgomery Co., PA. All the children that made the trip to North America but one seem to have stayed in/near the Montgomery Co. area, moved to the. Son Johannes, however, makes his way to South Carolina, where he dies. Perhaps this indicates a tie to Kaspar Kolb, who is described in a following section. Later descendants ranged as far as the Carolinas and Canada.

My efforts to tie Simon Culp (b.~1801) to the family of Dielman Kolb have so far failed. The closest that I have come is the discovery that Tillman Culp (b.1775) and family were in Scioto Co., OH, (just south of Marion Co., OH) during some of the time that Simon & his family were in Marion Co. See <https://familysearch.org/ark:/61903/1:1:MX7Q-BCD>. This certainly could be a coincidence.

## 4.2.7.2 Kaspar Kolb (b.~1708)

There is another Kolb immigrant named Kaspar Kolb, who is worthy of note. He and his family came to North America in about 1729, twelve years after Dielman and family. He relocated to the Carolinas in 1754. The reference that follows describes his descendants. Because of the relocation to the Carolinas, Kaspar is unlikely to be a direct line ancestor of Simon (b.~1801).

Descendants of Hans Kaspar Kolb - [http://www.mendheim-usa.com/Exhibits/Descendants%20of%20Hans%20Caspar%20\(Casper\)%20Kolb%20-%20Seven%20Generations.pdf](http://www.mendheim-usa.com/Exhibits/Descendants%20of%20Hans%20Caspar%20(Casper)%20Kolb%20-%20Seven%20Generations.pdf)

The existence of Kaspar does, however, provide evidence that other people with the Kolb surname migrated to America, and one of them may be an actual predecessor to Simon Culp.

For example, accessing this source at ancestry.com and looking for Kolb immigrants yielded an interesting return – one among 30 for the surname Kolb.:

See Pennsylvania German Pioneers: A Publication of the Original Lists of Arrivals in the Port of Philadelphia from 1727 to 1808, Vol. I; Description - Section: List of Pennsylvania German Pioneers, 1727-1775; Source Information - Pennsylvania German Pioneers: A Publication of the Original Lists of Arrivals in the Port of Philadelphia from 1727 to 1808, Vol. I [database on-line].

<i>Mortonhouse 1729</i>		25
Sworn Before the Governour in Council, 19 <sup>th</sup> August 1729. Cleared from Deal in Great Britain. James Coultas.		
R <sup>t</sup> Charles		
“At the Courthouse of Philadelphia, August 19 <sup>th</sup> , 1729, . . . A List was presented of the Names of Seventy five Palatines, who with their families, making in all about One hundred & Eighty persons, were imported here in the Ship Mortonhouse, James Coultas, Mr., from Rotterdam, but last from Deal, as by Clearance thence dated 21 <sup>st</sup> of June last.” From Minutes of the Provincial Council, printed in <i>Colonial Records</i> , Vol. III, p. 367.		
[List 9 B] Palatines imported in the ship Mortonhouse, Ja <sup>s</sup> Coultas, M <sup>r</sup> , from Rotterdam, but last from Deal p. Clearance thence, dated 21 <sup>st</sup> June 1729. Subscribed this Declaration 19 <sup>th</sup> Aug <sup>t</sup> . 1729.		
Carl Ernst Musselbach	Jakob Crebil	
Georg Threhr [Dreher]	Henrich Schlengeluf	
Johan Philip Ranck	Henrich Gunter	
Hans Müller	Hans Uldric (H) Vry	
Kunradt Wörntz	Christ (O) Vry	
Casper (X) Dorest	Jacob (O) Bowman	76 of 827
Dielman Kolb	Johan Nicolas Prietschler	

# Simon Culp and Ellen Selanders of PA, OH, KS

## 5 Conclusions

The main accomplishments of this research so far are the identification of the three Culp brothers, Simon, Andrew, and Samuel, as well as the discovery that my mother shows a genetic tie to each of them. It is hard to avoid the speculation that John and/or Catherine Snyder (who lived in Waldo Two, Marion Co., OH, in 1850) are genetically linked to people with the surname of Culp. The speculation that Catherine's maiden name was Culp seems to be the most likely explanation.

However, it is still necessary to find traditional evidence to prove or refute this speculation. To that end, I have requested help from the Cumberland County, PA, Historical Society. Perhaps they can find a marriage record for John and Catherine or a birth record for their first daughter, Susanna, that sheds some light on their ancestry.





## 281connections Wiki

**About**

**Copyright(left)**

**Education**

**Privacy**

**South Dakota Families**

**Bates-Moodie**

**Loy-Allen**

**Ahnentafel**

**AncestralCollapsible**

**FamilyGroup**

**Fan**

**Snyder Family Research**

**Tracing mtDNA**

**Memorials**

**Mysteries**

**Rombs-Kessler**

**Thompson-Olsen**

**Texas Families**

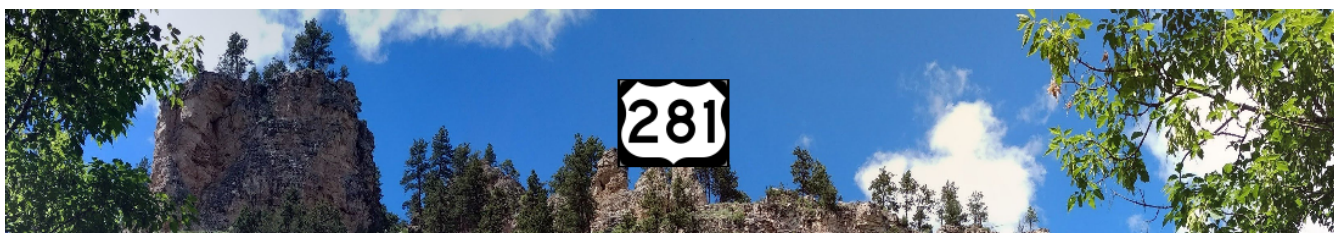

## Tracing mtDNA



Center Church of The Green, New Haven, CT

This is a description of a quest to identify all direct-line female descendants of a lady probably named Ellen (or Dorothy), who lived in Colonial Connecticut. I have not discovered her surname, but it seems that she married a man named John Thompson, and, after his death, she married a man named Thomas Harrison. The second marriage produced no female offspring, but her first marriage did yield

female offspring. I have found no hints about Ellen's ancestors. I assume that they were from England. As best I can tell, **Anna Allen's** maternal line traces clearly back to Ellen and John.

Why might such an analysis be useful? - Test results from familytreedna.com indicate that my mtDNA (,and hence Anna's,) is a close match to that of about a dozen people. Taking heteroplasmy into account, some of these may effectively be exact matches. The purpose of the work documented here is to create information that might help to identify our most recent common ancestor, who likely lived a few hundred years ago. There is a chance that our most recent common maternal ancestor existed in the American Colonies. Tracing the female descendants of my first maternal-line female ancestor to appear in colonial records might be used to identify the common ancestor if others can drive their family trees far enough back in time.

Having said all that, you can see/read considerably more detail in **a PDF** that describes 600+ descendants of Ellen that carried her mtDNA and who lived between 1640 and 1800 (roughly). And, there is a PDF that holds a **graphical rendering** of these people and that shows their interrelations. (The PDF is about 3 feet by more than 20 feet in size, so please don't try to print it! Use your PDF viewer to zoom and pan.) The surnames represented are listed below, followed by a picture of a name cloud representation to emphasize frequency of occurrence.

Allen, Alling, Andrews, Atwater, Ball, Barker, Barnes, Barney, Barrow, Bates, Beebe, Beecher, Benham, Booth, Bouton, Bradley, Brewster, Bristol, Chidsey, Cooper, Curtis, Downs, Eaton, Fenn, Foote, Ford, Frost, Gilbert, Grannis, Gregory, Harrison, Hatch, Hemmingway, Hickox, Hine, Hodges, Hopkins, Hotchkiss, Hudson, Humphreville, Johnson, Kimmy, Lines, Loy, Mallory, Martin, Morgan, Morris, Moulthrop, Munson, Murray, Nelson, Osborne, Painter, Palmer, Peck, Perkins, Pierpoint, Potter, Rhombs, Robbins, Rose, Ruggles, Russell, Sanford, Scoular, Shepard, Sherman, Smith, Sperry, Stone, Terrill, Thomas, Thompson, Todd, Tolles, Townsend, Turner, Utter, Walker, Warner, Whedon, Wolcott

Allen Alling Andrews Atwater Ball Barker Barnes Barney Barrow Bates  
 Beebe Beecher Benham Booth Bostwick Bouton Bradley Brewster Bristol  
 chatfield Chidsey Cooper Curtis Downs Eaton FENN Foote Ford Frost  
 Gilbert Grannis Gregory Harrison Hatch Hemmingway Hickox Hine Hitchcock  
 Hodges Hopkins Hotchkiss Hudson Humphreville Johnson Kimmy Lines Loy  
 Mallory Martin Morgan Morris Moulthrop Munson Murray Nelson  
 Osborne Painter Palmer Peck Perkins Pierpoint Potter Rhombs Robbins  
 Rose Ruggles Russell Sanford Scoular Shepard Sherman Smith sperry  
 Stone Terrill Thomas Thompson Todd Tolles Tomlinson Townsend  
 Turner Utter Walker Warner whedon Wolcott unknown

You will not find source references here. This is basically birth/marriage/death documentation to establish existence. I am recording some source information in a



family tree that I maintain and can share with you. So, I think that you have to regard this as a current estimate, subject to errors and corrections. It is something to work from, not a polished final product.

---

**Backlinks:**

[281connections Wiki>About](#)

[281connections Wiki:South Dakota Families:Loy-Allen](#)

[281connections Wiki:South Dakota Families:Mysteries](#)

Created with Zim-wiki & the Ecodiv-responsive template



Tracing Ellen's mtDNA

# Tracing Ellen's mtDNA

Craig Rhombs

## Tracing Ellen's mtDNA

### Table of Contents

Change log.....	6
Objective.....	7
The Family of John and Ellen Thompson.....	8
Hannah Thompson Moulthrop b. 1643 d. 1681.....	10
Hannah Moulthrop Russell b. 1665 d. 1713.....	11
Hannah Russell Gregory b. 1689 d. 1751.....	12
Lydia Russell Utter b. 1692 d. 1750.....	12
Lydia Utter Welton b. 1718 d. 1750.....	12
Mary Utter b. 1727 d. 1728.....	12
Sarah Utter b. 1730 d. 1731?.....	12
Abigail Russell Hodges b. 1701 d. ?.....	13
Abigail Hodges b. 1732 d.?.....	13
Rachel Russell Brewster b. 1703 d. ?.....	14
Mabel Russell Utter b. 1706 d. 1782.....	14
Sarah Russell Shepard b. 1711 d. ?.....	14
Sarah Shepard Chidsey b. 1728 d. 1783.....	15
Hannah Chidsey b. 1747 d. ?.....	15
Sarah Chidsey b. 1758 d. ?.....	15
Rhoda Chidsey b. 1764 d. 1820?.....	15
Mary Chidsey Curtis b. 1765 d. ?.....	16
Eunice Chidsey Walker b. 1768 d. ?.....	16
Mary Shepard b. 1731 d. 1743.....	17
Elizabeth Shepard Hotchkiss b. 1734 d. 1819.....	17
Mary Shepard b. 1746 d.?.....	17
Huldah Shepard Townsend b. 1755.....	18
Kezia Moulthrop Barker b. 1682 d. 1767.....	19
Hannah Barker Rose b. 1707 d. 1785.....	20
Kezia Barker Smith b. 1710 d. 1793.....	20
Lydia Barker Palmer b. 1712 d. 1781.....	21
Thankful Barker Rose b. 1719 d. 1791.....	22
Abigail Thompson Alsop Miles b. 1651 d. 1727.....	23
Rebecca Thompson Thomas b. 1651 d. 1716.....	25
Dorothy Thomas Tolles b. 1674 d. 1727.....	26
Experience Tolles Osborne b. 1694 d. 1737.....	26
Esther Osborne Booth b. 1721 d. ?.....	27
Rachel Tolles Ruggles b. 1710 d. 1746.....	28
Lois Ruggles Warner b. 1721 d. 1781.....	28
Rachel Ruggles Bishop b. 1732 d. 1800.....	29
Mercy Ruggles Bostwick b. 1732 d. 1822.....	30
Mabel Ruggles Bostwick b. 1736 d. 1804.....	31
Dorothy Tolles Bristol b. 1711 d. 1785.....	32

## Tracing Ellen's mtDNA

Rachel Bristol Smith Downs b. 1739 d. 1817.....	32
Dorothy Bristol Thomas b. 1748 d. 1834.....	32
Dinah Bristol Candee b. 1751 d. 1785.....	32
Mary Tolles b. 1730 d. 1731?.....	33
Dinah Thomas Sherman b. 1678 d. 1769.....	34
Lydia Sherman Todd b. 1699 d. 1733.....	35
Lydia Todd Smith b. 1727 d. 1819.....	35
Lois Todd Turner b. 1729 d. 1812.....	36
Eunice Todd Gilbert b. 1732 d. 1832.....	37
Dinah Sherman Atwater b. 1702 d. 1739.....	38
Abigail Atwater Peck b. 1727 d. ?.....	39
Lydia Atwater b. 1734 d. 1748?.....	40
Rachel Atwater Bradley b. 1737 d. 1809.....	40
Elizabeth Sherman Gilbert b. 1708 d. 1738.....	41
Sarah Gilbert Potter b. 1730 d. 1798.....	41
Recompence Thomas b. 1683 d. 1703.....	43
Experience Thomas b. 1687 d. 1703.....	43
Mary Thompson Cooper b. 1652 d. ? *.....	44
Sarah Cooper Munson b. 1673 d. 1736.....	45
Hannah Munson Andrews b. 1697 d. 1785.....	45
Amy Munson Sperry b. 1704 d. ?.....	45
Rebecca Sperry Osborn b. 1730 d. ?.....	45
Amy Sperry b. 1732 d. 1748.....	46
Phebe Sperry Downs b. 1735 d. ?.....	46
Thankful Sperry b. 1740 d. 1740?.....	46
Ruth Munson Hotchkiss b. 1708 d. 1785.....	47
Esther Hotchkiss Murray b. 1745 d. 1831.....	47
Mehitabel Munson Morris b. 1709.....	48
Sarah Morris b. 1737 d. 1829?.....	48
Elizabeth Morris Humpreville b. 1739 d. ?.....	48
Sarah Munson Stone b. 1713 d. 1737.....	49
Elizabeth Stone b. 1735 d. ?.....	49
Elizabeth Munson Perkins b. 1695 d. ?.....	49
Amy Perkins Peck b. 1726 d. 1799.....	49
Eleanor Perkins Hotchkiss b. 1726 d. 1816.....	49
Mary Cooper Smith b. 1677 d. 1761 *.....	50
Obedience Smith b. 1705 d. 1705.....	50
Mary Smith Painter b. 1707 d. 1786.....	51
Mary Painter Mallory b. 1728 d. 1804.....	51
Amy Painter b. 1730 d. 1751.....	52
Abigail Painter b. 1738 d. 1755.....	52
Rebecca Painter b. 1744 d. 1788.....	52
Freelove Painter b. 1749 d. 1751.....	52

## Tracing Ellen's mtDNA

Amy Smith b. 1709 d. ?.....	53
Margaret Smith Smith(!) b. 1711 d. 1803 *.....	53
Margaret Smith Thompson b. 1734 d. 1821.....	53
Mary Smith (Thompson?) b. 1737 d. 1773.....	54
Hannah Smith Hickox b. 1746/1747 d. ?.....	54
Philena Smith Hickox b. 1750 d. 1826 *.....	55
Sarah Hickox Beebe b. 1774 d. 1864.....	55
Polly Hickox Warner b. 1777 d. 1849 *.....	55
Hannah Smith Hickox Terrill b. 1781 d. 1856.....	56
David Hickox b. 1772 d. 1847.....	56
Mehitabel Smith Benham b. 1755 d. 1834.....	57
Thankful Smith Tolles b. 1712 d. 1769.....	58
Thankful Tolles Sanford b. 1737 d. 1820.....	59
Dorothy Tolles b. 1745 d. 1745?.....	60
Desire Tolles Beecher b. 1745 d. 1812.....	60
Mary Tolles Thomas b. 1756 d. 1842.....	60
Abigail Cooper Johnson b. 1679 d. 1724.....	61
Eunice Johnson (Sperry?) b. 1703 d. 1725.....	61
Hannah Cooper Lines b. 1681 d. 1772.....	62
Kezia Lines Alling b. 1715 d. 1782.....	63
Ruth Alling Hine b. 1738 d. 1777.....	63
Kezia Alling b. 1748 d. 1765.....	64
Eleanor Alling Frisbie b. 1751 d. ?.....	64
Hannah Alling Peck b. 1751 d. ?.....	64
Rebecca Cooper Alling b. 1689 d. 1770.....	65
Phebe Alling Talmadge Wolcott b. 1723 d. 1788.....	65
Phebe Wolcott Barney b. 1755 d. 1832.....	66
Rebecca Wolcott Turner b. 1759 d. 1838.....	66
Sarah Thompson Alling b. 1654 d. 1716.....	67
Undocumented Lines (Dead-ends).....	68
Along Hannah Thompson's Line.....	68
The daughters of Mabel Russell and Benjamin Utter.....	68
Sarah Utter (b.1730), daughter of Lydia Russell (b. 1692) and Abraham Utter (b. 1688).....	69
Abigail Hodges (b. 1731), daughter of Abigail Russell (b. 1701) and Abraham Hodges (b. 1697)	69
.....	69
First Daughter of Sarah Shepard Chidsey (b.1728), Hannah Chidsey (b. 1747).....	70
Sarah Chidsey (b. 1758), daughter of Sarah Shepard (b. 1728) and John Chidsey (b. 1720).....	70
Rhoda Chidsey (b. 1764), daughter of Sarah Shepard (b. 1728) and John Chidsey (b. 1720).....	70
Mary Shepard's Identity(ies).....	71
Esther Palmer (b. 1751), daughter of Lydia Barker Palmer (b. 1712).....	71
Along Rebecca Thompson's Line.....	72
Elizabeth / Betsy Booth b. 1753.....	72
Sarah Gilbert (1758-?).....	72

## Tracing Ellen's mtDNA

Mary Peck b. 1758 d. ?.....	72
Pamela Peck b. 1761 d. ?.....	72
Mary Dinah Peck b. 1767.....	72
Along Mary Thompson's Line.....	73
Elizabeth Stone b. 1735 d. ?.....	73
Mary (1757? -?), the Daughter of Ruth Alling Hine b. 1738 d. 1777.....	73
Eunice Johnson (Sperry?) b. 1703 d. 1725.....	73
Rebecca Painter (Sherman?) b. 1744 d. 1788.....	73
Amy Smith b. 1709 d. ?.....	74
Mary Smith (Thompson?) b. 1737 d. 1773.....	74
Descendants of Ellen Thompson and John Thompson – until 1800 +/-.....	75

Note: the \* in the table of contents entries indicates my direct maternal line. The headings for these sections are also highlighted in yellow below.

## Tracing Ellen's mtDNA

### Change log

rev. 01, 2/9/2019: This version reflects the completion of an analysis of the female descendants of Hannah Thompson Moulthrop through roughly 1800. I added a section to summarize "Undocumented Lines (Dead-ends)". This is where I am collecting a list of research problems that may indicate that more individuals might be found if the problems can be solved.

Rev. 02, 2/10/2019: Information added for Abigail Thompson Alsop and Kezia Moulthrop Barker's lines.

Rev. 02, 2/12/2019: Finished Sarah Thompson's line.

Rev. 03, 2/22/2019: Finished all Thompson lines. This is the first complete draft.

Rev. 04, 2/24/2019: Revised information about Elizabeth Booth, daughter of Esther Osborn Booth. Death information looks very shaky, so turned her death date and location to unknown. Updated info for Lydia Todd Smith – I had missed her daughter Mary (b. 1747).

Rev. 05 3/17/2019: Added information along Mary Pinter's line in an effort to extend that line to provide a proposed connection to a mtDNA cousin. (See the section on Mary Painter Mallory.) I also updated the descendant report at the end of this document.



## Tracing Ellen's mtDNA

### Objective

Test results from familytreedna.com indicate that my mtDNA is a close match to that of about a dozen people. Taking heteroplasmy into account, some of these may effectively be exact matches. The purpose of the work documented here is to investigate one line of reasoning that might help to identify our most recent common ancestor, who likely lived a few hundred years ago.

There is a chance that our most recent common maternal ancestor existed in the American Colonies. Tracing the female descendants of my first maternal-line female ancestor to appear in colonial records might then identify the common ancestor if others can drive their family trees far enough back in time.

I am lucky to have had the assistance of one of the people with matching mtDNA. This person has traced her maternal line back to Fairfield Co., CT, in the late 1700s, but there is a roadblock at that point. My maternal line starts in the area of New Haven Co., CT, and I have a clear trail of linked ancestors leading back to myself. Perhaps this work will help break the roadblock and help us to determine if our most recent common maternal ancestor lived in England or the American Colonies.

So, this is a description of a quest to identify all direct-line female descendants of a lady probably named Ellen, who lived in Colonial Connecticut. I have not discovered her surname, but it seems that she married a man named John Thompson, and, after his death, she married a man named Thomas Harrison. The second marriage produced no female offspring, but her first marriage did yield female offspring.

By the way, I have found no hints about Ellen's ancestors. I assume that they were from England.

You will not find source references here. This is basically a birth/marriage/death document to establish existence. I am recording some source information in a family tree that I maintain. So, I think that you have to regard what follows as a current estimate, subject to errors and corrections. It is something to work from, not a polished final product.

## Tracing Ellen's mtDNA

### The Family of John and Ellen Thompson

Here is a family group chart . It illustrates that Ellen had five daughters, whose lines I trace below.

Family Group Report		
<b>Husband: Thompson, John</b>		
Birth	1617	England
Death	1656	
Father		
Mother		
<b>Wife: unknown, Ellen</b>		
Birth	speculation	
	1621	England
Death	1656-1666?	
		New Haven County, CT, Connecticut
Father		
Mother		
<b>Children</b>		
<b>1M</b>	<b>Thompson, John Jr.</b>	
	Birth	1641
	Death	1693-02-13
	Spouse	Powell, Priscilla
	Marriage	1666-05-22
<b>2F</b>	<b>Thompson, Hannah</b>	
	Birth	1643
	Death	1681
	Spouse	Moulthrop, Matthew
	Marriage	1662-06-26
<b>3M</b>	<b>Thompson, Ebenezer</b>	
	Birth	1648-10-15
	Death	1674
<b>4M</b>	<b>Thompson, Joseph</b>	
	Birth	1649
	Death	1703
	Spouse	Lathrop, Elizabeth
<b>5F</b>	<b>Thompson, Abigail</b>	
	Birth	1651-01-26
	Death	1727
	Spouse	Alsop, Joseph
	Marriage	1672-11-25
<b>6F</b>	<b>Thompson, Rebecca</b>	
	Birth	1651-01-26
	Death	1716
	Spouse	Thomas, Daniel
	Marriage	1669-02-03
<b>7F</b>	<b>Thompson, Mary</b>	
	Birth	1652-04-24
	Death	1714-11-00
	Spouse	Cooper, John Junior
	Marriage	1666-12-27
<b>8F</b>	<b>Thompson, Sarah</b>	
	Birth	1654-04-30
	Death	1716-10-23
	Spouse	Ball, Alling

## Tracing Ellen's mtDNA

Here is a different view of Ellen's families, not just the one with John Thompson.

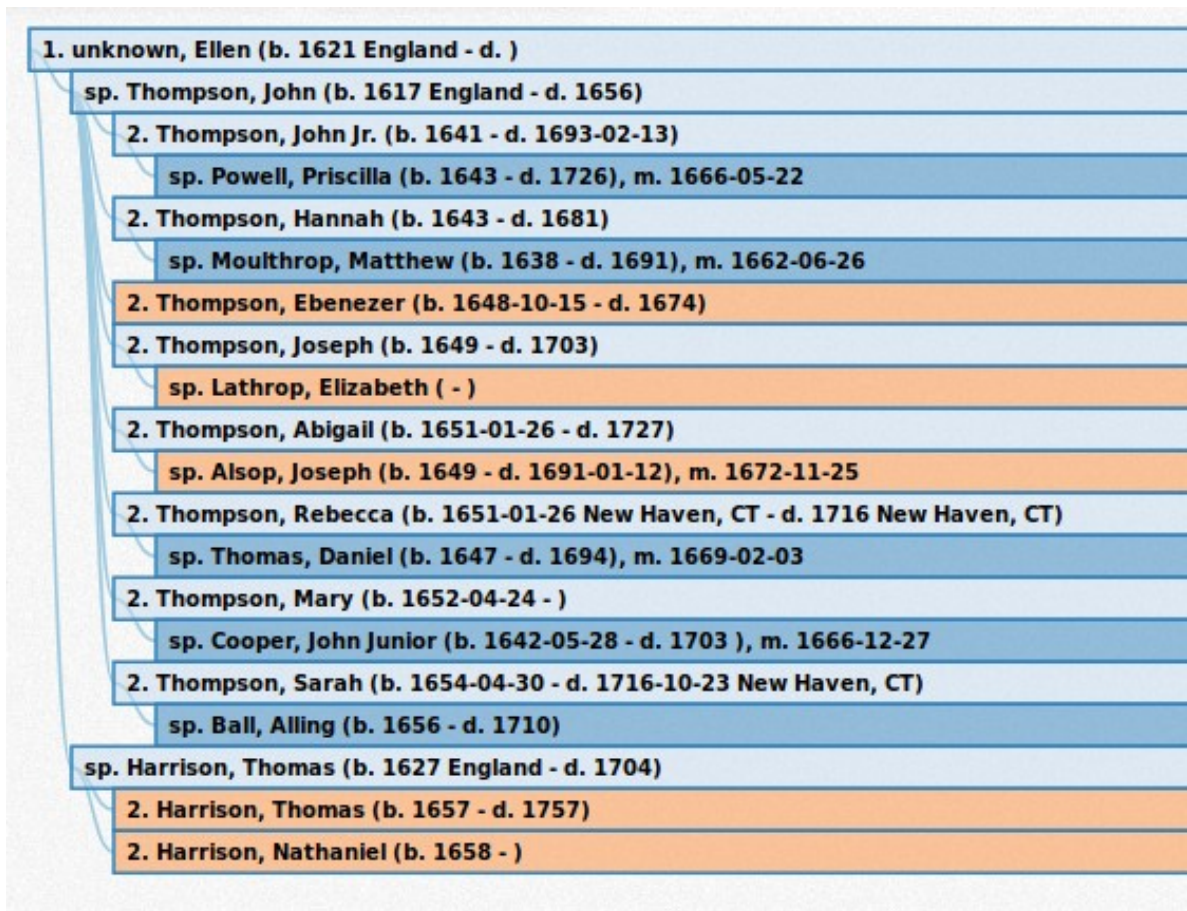

I am assuming (without concrete evidence) that John and Ellen were born in England at about the years shown.

Following this are best current estimates of the female descendants of Ellen's five daughters. (Note that her second marriage only yielded sons.) My objective is to document the estimated maternal lines into the late 18<sup>th</sup> century.

## Tracing Ellen's mtDNA

### Hannah Thompson Moulthrop b. 1643 d. 1681

Here is a depiction of two generations of Hannah's descendants.

Hannah has two daughters that potentially can further the mtDNA line – Hannah b. 1665 and Kezia/Keziah b. 1682.

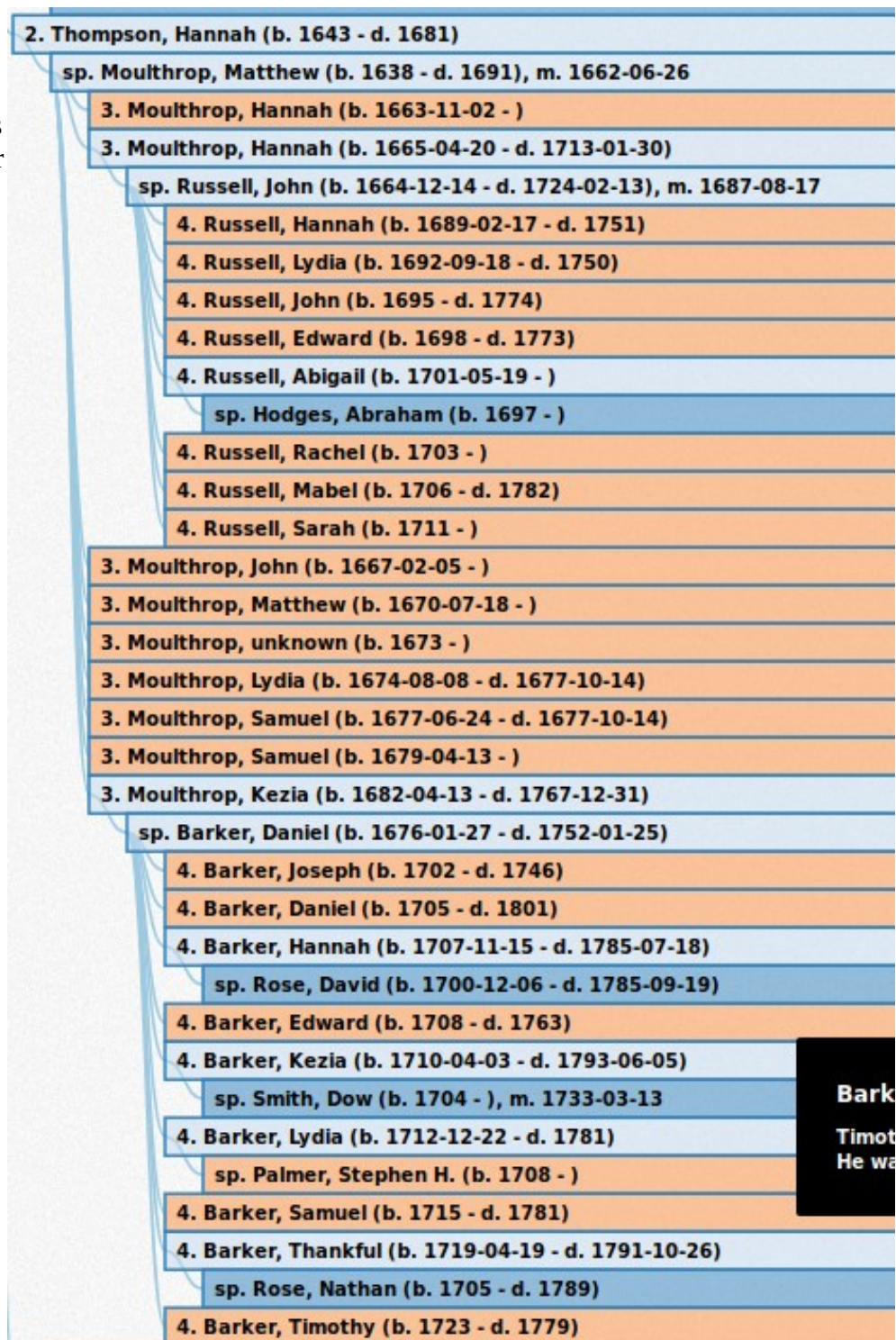

## Tracing Ellen's mtDNA

### Hannah Moulthrop Russell b. 1665 d. 1713

Hannah has the following daughters of interest –

Hannah Russell,

Lydia Russell,

Abigail Russell,

Rachel Russell,

Mabel Russell, and

Sarah Russell.

The screenshot displays a genealogy software interface. At the top, it shows two individuals: 'Father/partner1' (John Russell, ID 11547) and 'Mother/partner2' (Hannah Moulthrop, ID 11498). Below this is the 'Relationship Information' section, which includes an ID field (F0403) and a Type field (Married). A 'Tags' field is also present. The main part of the screenshot is a table titled 'Children' with columns for '#', 'ID', 'Name', 'Gender', 'Paternal', 'Maternal', and 'Birth Date'. The table lists eight children of John and Hannah.

#	ID	Name	Gender	Paternal	Maternal	Birth Date
1	I1548	Russell, Hannah	female	Birth	Birth	1689-02-17
2	I1555	Russell, Lydia	female	Birth	Birth	1692-09-18
3	I1556	Russell, John	male	Birth	Birth	1695
4	I1557	Russell, Edward	male	Birth	Birth	1698-04-19
5	I1558	Russell, Abigail	female	Birth	Birth	1701-05-19
6	I1559	Russell, Rachel	female	Birth	Birth	1703-12-15
7	I1560	Russell, Mabel	female	Birth	Birth	1706-07-14
8	I1561	Russell, Sarah	female	Birth	Birth	1711-02-23

Information about their female descendants follows.

## Tracing Ellen's mtDNA

### **Hannah Russell Gregory b. 1689 d. 1751**

It appears that Hannah and her husband, Joseph Gregory b.1674, had no daughters.

### **Lydia Russell Utter b. 1692 d. 1750**

Lydia's candidate daughters are . . .

Lydia Utter b. 1718 d. 1750

Mary Utter b. 1727

Sarah Utter b. 1730

Information for each follows.

<b>4. Russell, Lydia (b. 1692-09-18 - d. 1750)</b>
sp. <b>Utter, Abraham (b. 1688 - d. 1761), m. 1715-06-27</b>
<b>5. Utter, Abraham (b. 1716 - d. 1779)</b>
<b>5. Utter, Lydia (b. 1718-11-24 - d. 1750-08-21)</b>
<b>5. Utter, Samuel (b. 1720 - )</b>
<b>5. Utter, John (b. 1722 - )</b>
<b>5. Utter, Isaac (b. 1724 - )</b>
<b>5. Utter, Mary (b. 1727-11-24 - )</b>
<b>5. Utter, Sarah (b. 1730-07-03 - )</b>
<b>5. Utter, Jabez (b. 1733 - )</b>

### **Lydia Utter Welton b. 1718 d. 1750**

Findagrave.com entries indicate that this couple had no children.

### **Mary Utter b. 1727 d. 1728**

The consensus based only on pedigree charts at familyserach.org is that Mary did not survive long. (Not strong evidence, but all that I can find at this time.)

### **Sarah Utter b. 1730 d. 1731?**

There is conflicting information about the fate of Sarah. She may have died within a year of birth or she may have married Phillip Knight of Rhode Island, where she died in 1759, after having two daughters – Phebe (b. 1756) and Sarah (b. 1757). Requires more careful research to get a better idea of the truth.

## Tracing Ellen's mtDNA

### **Abigail Russell Hodges b. 1701 d. ?**

Abigail had just one daughter, also named Abigail b. 1732. I need to investigate any family(ies) that she may have had.

Name: Hodges, Abraham [1572]	Name: Russell, Abigail [1558]
Birth: 1697	Birth: 1701-05-19
Death:	Death:

**Relationship Information**

ID:  Type:

Tags:

**Children** Events Source Citations Attributes Notes Gallery LDS

#	ID	Name	Gender	Paternal	Maternal	Birth Date
1	I1610	Hodges, Isaac	male	Birth	Birth	1729
2	I1611	Hodges, Abraham	male	Birth	Birth	1726
3	I1612	Hodges, Abigail	female	Birth	Birth	1732
4	I1613	Hodges, David	male	Birth	Birth	1733
5	I1614	Hodges, Samuel	male	Birth	Birth	1736

### **Abigail Hodges b. 1732 d.?**

I can find no records other than a birth record for Abigail Hodges of the New Haven / Waterbury area.

## Tracing Ellen's mtDNA

### ***Rachel Russell Brewster b. 1703 d. ?***

It appears that Rachel and her husband, William Brewster, had no daughters. They probably moved to Dutchess Co., NY, from CT.

### ***Mabel Russell Utter b. 1706 d. 1782***

Mable and Benjamin appear to have had two daughters, Mary b. 1737 and Mabel b. 1765. I have found no records of marriages for these daughters, who were born quite far apart in time.

### ***Sarah Russell Shepard b. 1711 d. ?***

Sarah Russell appears to have had five daughters with her husband, John Shepard b. 1696.

Sarah Shepard (married to John Chidsey)

Mary Shepard

Elizabeth Shepard  
(married to Enos Hotchkiss)

Mary Shepard

Huldah Shepard  
(married to Elias Townsend)

Father/partner1		Mother/partner2				
Name:	Shepard, John [I1654]	Name:	Russell, Sarah [I1561]			
Birth:	1696-08-09	Birth:	1711-02-23			
Death:	1780-05-18	Death:	1761-01-01			
<b>Relationship Information</b>						
ID:	F0423	Type:	Married			
Tags:						
<b>Children</b>   Events   Source Citations   Attributes   Notes   Gallery   LDS						
#	ID	Name	Gender	Paternal	Maternal	Birth Date
1	I1655	Shepard, Sarah	female	Birth	Birth	1728-03-11
2	I1656	Shepard, Mary	female	Birth	Birth	1731-09-13
3	I1657	Shepard, Elizabeth	female	Birth	Birth	1734-07-20
4	I1658	Shepard, John	male	Birth	Birth	1736
5	I1659	Shepard, Stephen	male	Birth	Birth	1740
6	I1660	Shepard, John	male	Birth	Birth	1743
7	I1661	Shepard, Mary	female	Birth	Birth	1746-09-30
8	I1662	Shepard, Levi	male	Birth	Birth	1753
9	I1663	Shepard, Huldah	female	Birth	Birth	1755-11-25



## Tracing Ellen's mtDNA

### **Sarah Shepard Chidsey b. 1728 d. 1783**

Sarah and John had the following daughters. -

Hannah

Sarah

Rhoda

Mary

Eunice

Father/partner1		Mother/partner2				
Name:	Chidsey, John [I1665]	Name:	Shepard, Sarah [I1655]			
Birth:	1720-09-15	Birth:	1728-03-11			
Death:	1783-09-17	Death:	1783-06-01			
<b>Relationship Information</b>						
ID:	F0425	Type:	Married			
Tags:						
<b>Children</b>   Events   Source Citations   Attributes   Notes   Gallery   LDS						
#	ID	Name	Gender	Paternal	Maternal	Birth Date
1	I1666	Chidsey, Hannah	female	Birth	Birth	1740-05-06
2	I1667	Chidsey, John	male	Birth	Birth	1749-12-16
3	I1668	Chidsey, Ephraim	male	Birth	Birth	1752-03-19
4	I1669	Chidsey, Roswell	male	Birth	Birth	1754-07-17
5	I1670	Chidsey, Street	male	Birth	Birth	1756-11-15
6	I1671	Chidsey, Sarah	female	Birth	Birth	1758-10-20
7	I1672	Chidsey, Simon	male	Birth	Birth	1762-03-03
8	I1673	Chidsey, Rhoda	female	Birth	Birth	1764-07-21
9	I1674	Chidsey, Mary	female	Birth	Birth	1765-09-26
10	I1675	Chidsey, Eunice	female	Birth	Birth	1768-05-01
11	I1676	Chidsey, Samuel	male	Birth	Birth	1770-10-08
12	I1677	Chidsey, Ezekiel	male	Birth	Birth	1770-10-08

### ***Hannah Chidsey b. 1747 d. ?***

I have been unable to trace much information for this individual. There is a reference to Dodd's East Haven (register?) to indicate a death in 1840! More work is needed here to get a clear picture, if possible.

### ***Sarah Chidsey b. 1758 d. ?***

Sarah appears to have been married to Richard Barrett in East haven, CT, on 1/13/1780. However, it is not clear whether they had children. In fact it is not at all clear that this is a correct association. More investigation is required.

### ***Rhoda Chidsey b. 1764 d. 1820?***

Rhoda may have married William Seymour and ended up in Delaware Co., NY. If so, she had daughters. However, all that is available online that I can find appears to be hearsay. More work is needed here.

## Tracing Ellen's mtDNA

### **Mary Chidsey Curtis b. 1765 d. ?**

Mary married Phineas Curtis and they had a fairly large number of children, including five females.

**Father/partner1**

Name: Curtis, Phineas [I1678]  
 Birth: 1765  
 Death: 1806

**Mother/partner2**

Name: Chidsey, Mary [I1674]  
 Birth: 1765-09-26  
 Death:

**Relationship Information**

ID:  Type:

Tags:

**Children**

Events

Source Citations

Attributes

Notes

Gallery

LDS

#	ID	Name	Gender	Paternal	Maternal	Birth Date
1	I1679	Curtis, Polly	female	Birth	Birth	1788
2	I1680	Curtis, Hannah	female	Birth	Birth	1790
3	I1681	Curtis, Russell	male	Birth	Birth	1792
4	I1682	Curtis, Lowly	female	Birth	Birth	1794
5	I1683	Curtis, Asenath	female	Birth	Birth	1796
6	I1684	Curtis, Benjamin	male	Birth	Birth	1798
7	I1685	Curtis, Major	male	Birth	Birth	1800
8	I1686	Curtis, John	male	Birth	Birth	1802
9	I1687	Curtis, Susan	female	Birth	Birth	1804
...	I1688	Curtis, Street	male	Birth	Birth	1806

### **Eunice Chidsey Walker b. 1768 d. ?**

I appears that Eunice married William Walker (b. 1766) and they had only three male offspring.

**Father/partner1**

Name: Walker, William [I1689]  
 Birth: 1766-02-06  
 Death:

**Mother/partner2**

Name: Chidsey, Eunice [I1675]  
 Birth: 1768-05-01  
 Death:

**Relationship Information**

ID:  Type:

Tags:

**Children**

Events

Source Citations

Attributes

Notes

Gallery

LDS

#	ID	Name	Gender	Paternal	Maternal	Birth Date
1	I1691	Walker, John	male	Birth	Birth	1788
2	I1692	Walker, William	male	Birth	Birth	1790
3	I1690	Walker, James	male	Birth	Birth	1792

## Tracing Ellen's mtDNA

### **Mary Shepard b. 1731 d. 1743**

Since this Mary Shepard died at about the age of 12, it is reasonable to assume that she had no children.

### **Elizabeth Shepard Hotchkiss b. 1734 d. 1819**

Elizabeth married Enos Hotchkiss, and her findagrave memorial indicates that she and Enos had four children before they died in Vermont.

Father/partner1		Mother/partner2				
Name:	Hotchkiss, Enos [I1693]	Name:	Shepard, Elizabeth [I1657]			
Birth:	1731-05-13	Birth:	1734-07-20			
Death:	1806-10-27	Death:	1819-02-21			
<b>Relationship Information</b>						
ID:	<input type="text"/>	Type:	Married			
Tags:						
Children Events Source Citations Attributes Notes Gallery LDS						
+ -						
#	ID	Name	Gender	Paternal	Maternal	Birth Date
1	I1694	Hotchkiss, Huldah	female	Birth	Birth	
2	I1695	Hotchkiss, Elihu	male	Birth	Birth	1756
3	I1696	Hotchkiss, Enoch	male	Birth	Birth	1763
4	I1697	Hotchkiss, Stephen	male	Birth	Birth	1772

### **Mary Shepard b. 1746 d.?**

I am afraid that there is confusion in the ranks over two families - one headed by Mary Shepard and David Grannis, offspring of Russell and Lydia (Forbes) Grannis and Thomas and Sarah (Hotchkiss) Shepard. The children of this marriage are often listed with the same names as the one from the other marriage - that being between Sarah Russell (daughter of John and Sarah (Russell) Shepard) and the same David Grannis.

The issue of the two Mary's needs to be resolved before anything can be confidently concluded about marriages and offspring.

References:

The Church of Jesus Christ of Latter-day Saints, "International Genealogical Index (IGI)," database, FamilySearch (<https://familysearch.org/ark:/61903/2:1:M6YR-8N1> : accessed 9 February 2019), entry for Mary Shepard, batch A22760-7; citing FHL microfilm 455,111; submitter not specified.

## Tracing Ellen's mtDNA

"Pedigree Resource File," database, FamilySearch (<https://familysearch.org/ark:/61903/2:2:SB1J-9LL> : accessed 9 February 2019), entry for Mary /Shepard/, cites sources; file (2:2:2:MMW8-HB9), submitted 15 May 2011.

### Huldah Shepard Townsend b. 1755

Huldah married Elias Townsend and they had an assortment of children. It may be that they moved west into NY.

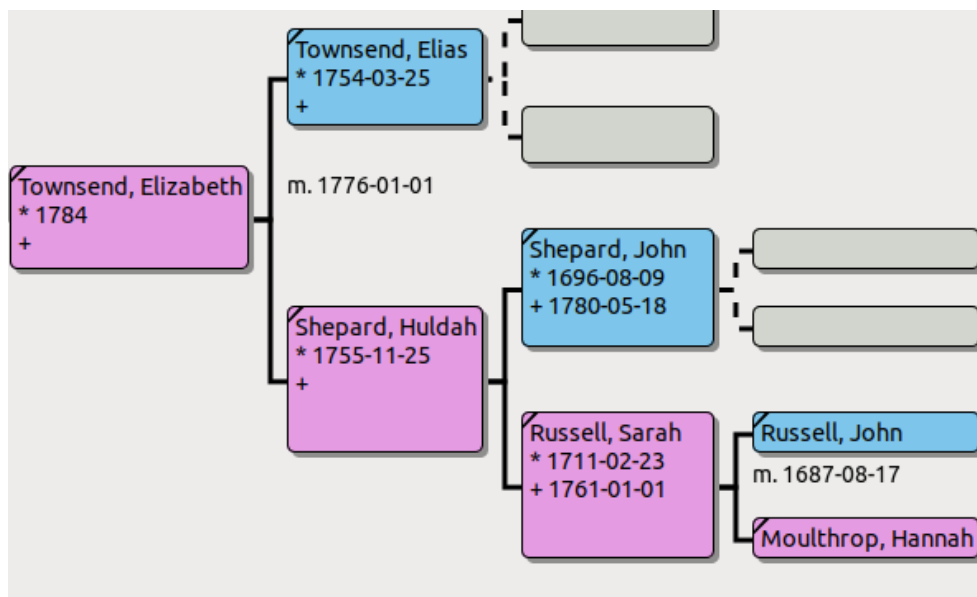

**Father/partner1** -

Name: Townsend, Elias [I1740]  
 Birth: 1754-03-25  
 Death:

**Mother/partner2** -

Name: Shepard, Huldah [I1663]  
 Birth: 1755-11-25  
 Death:

**Relationship Information**

ID:  Type: Married

Tags:

Children
Events
Source Citations
Attributes
Notes
Gallery
LDS

#	ID	Name	Gender	Paternal	Maternal	Birth Date
1	I1741	Townsend, Huldah	female	Birth	Birth	1782
2	I1742	Townsend, Elias	male	Birth	Birth	1779
3	I1743	Townsend, Elizabeth	female	Birth	Birth	1784
4	I1744	Townsend, Nancy	female	Birth	Birth	1788

## Tracing Ellen's mtDNA

### **Kezia Moulthrop Barker b. 1682 d. 1767**

Kezia's children of interest are

Hannah Barker,

Kezia Barker,

Lydia Barker,

Thankful Barker.

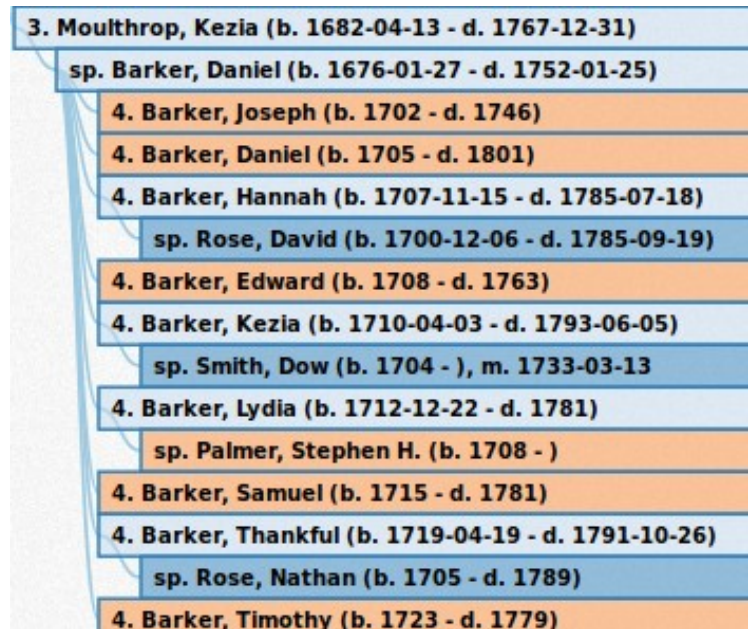

## Tracing Ellen's mtDNA

### **Hannah Barker Rose b. 1707 d. 1785**

Hannah and her husband David Rose had just one daughter – Kesiah.

Unfortunately her story appears to be a sad one. - She married David Hudson. Kesiah must have died in childbirth and

**Father/partner1** -

Name: Rose, David [I1615]  
Birth: 1700-12-06  
Death: 1785-09-19

**Mother/partner2** -

Name: Barker, Hannah [I1565]  
Birth: 1707-11-15  
Death: 1785-07-18

**Relationship Information**

ID:  Type:

Tags:

**Children** Events Source Citations Attributes Notes Gallery LDS

#	ID	Name	Gender	Paternal	Maternal	Birth Date
1	I1616	Rose, Keziah	female	Birth	Birth	1730
2	I1617	Rose, David	male	Birth	Birth	1736
3	I1618	Rose, Simeon	male	Birth	Birth	1747
4	I1619	Rose, Levi	male	Birth	Birth	1751

the son, also named David, only survived about 4 months. Kesiah's husband did not wait to remarry. He married Rebecca Fowler the next summer.

### **Kezia Barker Smith b. 1710 d. 1793**

Kesia and her husband only produced male offspring from what I can tell.

**Father/partner1** -

Name: Smith, Dow [I1621]  
Birth: 1704  
Death:

**Mother/partner2** -

Name: Barker, Kezia [I1567]  
Birth: 1710-04-03  
Death: 1793-06-05

**Relationship Information**

ID:  Type:

Tags:

**Children** Events Source Citations Attributes Notes Gallery LDS

#	ID	Name	Gender	Paternal	Maternal	Birth Date
1	I1622	Smith, Isaac	male	Birth	Birth	1743
2	I1623	Smith, Dow	male	Birth	Birth	1745
3	I1624	Smith, Daniel	male	Birth	Birth	1748
4	I1625	Smith, Jordan	male	Birth	Birth	1733

## Tracing Ellen's mtDNA

### **Lydia Barker Palmer b. 1712 d. 1781**

Lydia married Stephen H. Palmer and they had a family that included two daughters – Phebe and Esther.

**Father/partner1**

Name: Palmer, Stephen H. [I1620]  
 Birth: 1708  
 Death: 1782-04-06

**Mother/partner2**

Name: Barker, Lydia [I1568]  
 Birth: 1712-12-22  
 Death: 1781-04-13

**Relationship Information**

ID:  Type:

Tags:

**Children** | Events | Source Citations | Attributes | Notes | Gallery | LDS

#	ID	Name	Gender	Paternal	Maternal	Birth Date
1	I1749	Palmer, Stephen	male	Birth	Birth	1735
2	I1750	Palmer, Phebe	female	Birth	Birth	1738-03-03
3	I1751	Palmer, Ebenezer	male	Birth	Birth	1743
4	I1752	Palmer, Asahel	male	Birth	Birth	1747
5	I1753	Palmer, Esther	female	Birth	Birth	1751-11-27

Daughter Phebe married Ebenezer Foote in Branford, CT. They had daughters Thankful (b. 1759), who married Isaac Smith (b. 1755 – a cousin?), and Lucretia (b. 1765), who married James Butler (b. 1761). The while family seems to have been in the Branford area in the late 18<sup>th</sup> century.

**Father/partner1**

Name: Foote, Ebenezer [I1754]  
 Birth: 1734  
 Death:

**Mother/partner2**

Name: Palmer, Phebe [I1750]  
 Birth: 1738-03-03  
 Death: 1788

**Relationship Information**

ID:  Type:

Tags:

**Children** | Events | Source Citations | Attributes | Notes | Gallery | LDS

#	ID	Name	Gender	Paternal	Maternal	Birth Date
1	I1755	Foote, Thankful	female	Birth	Birth	1759-09-24
2	I1756	Foote, Lucretia	female	Birth	Birth	1775-09-24

I have been unable to find anything other than a birth record for the daughter named Esther.

## Tracing Ellen's mtDNA

### **Thankful Barker Rose b. 1719 d. 1791**

Thankful and her husband, Nathan, had a family that included one girl, named Sarah.

**Father/partner1**

Name: Rose, Nathan [I1626]  
 Birth: 1705  
 Death: 1789

**Mother/partner2**

Name: Barker, Thankful [I1570]  
 Birth: 1719-04-19  
 Death: 1791-10-26

**Relationship Information**

ID:  Type:

Tags:

**Children**
Events
Source Citations
Attributes
 Notes
Gallery
LDS

#	ID	Name	Gender	Paternal	Maternal	Birth Date
1	I1627	Rose, Sarah	female	Birth	Birth	1748-04-24
2	I1759	Rose, Joseph	male	Birth	Birth	
3	I1760	Rose, Nathan	male	Birth	Birth	

Sarah married Solomon Whedon. They appear to have ended their days in Litchfield Co., CT. I have not traced their daughter, Lucretia.

**Father/partner1**

Name: Whedon, Solomon [I1628]  
 Birth: 1749  
 Death: 1814-12-12

**Mother/partner2**

Name: Rose, Sarah [I1627]  
 Birth: 1748-04-24  
 Death: 1821-01-10

**Relationship Information**

ID:  Type:

Tags:

**Children**
Events
Source Citations
Attributes
Notes
Gallery
LDS

#	ID	Name	Gender	Paternal	Maternal	Birth Date
1	I1629	Whedon, Lucretia	female	Birth	Birth	1782



## Tracing Ellen's mtDNA

### **Abigail Thompson Alsop Miles b. 1651 d. 1727**

Her findagrave memorial ([https://www.findagrave.com/memorial/64415523/abigail-alsop\\_miles#source](https://www.findagrave.com/memorial/64415523/abigail-alsop_miles#source) ) reads as follows.

“

Abigail (twin) was the 4-5th child and 3rd -4th daughter of John & Ellen (\_\_\_\_) Thompson of East Haven. She was b. 26 Jan 1651; m. (1) 25 Nov 1672 Joseph Alsop, Jr. (b. abt 1694 & d. 12 Jan 1691). She m. (2) Capt. John Miles, Jr. (b. 9 Jan 1668 & d. 10 Feb 1710). She d. 1727.

”

I can find no evidence that either of her marriages produced children.

Abigail's first husband was Joseph Alsop, whose findagrave memorial ([https://www.findagrave.com/memorial/8639056/joseph-alsop\\_allsup](https://www.findagrave.com/memorial/8639056/joseph-alsop_allsup) ) reads as follows.

“

~MY ALSOP & THOMPSON FAMILIES~

Joseph was the son of Joseph & Elizabeth (Preston) Alsop and grandson of my ancestors, JOHN & TEMPERENCE (GILBERT) ALSOP of Derbyshire, England.

His father, Joseph, Sr. came from London to America in 1635 in the "Elizabeth & Ann." He was a mariner.

Joseph, Jr. married Abigail Thompson, daughter of my ancestors, JOHN & ELLEN (HARRISON) THOMPSON on 25 Nov 1672 in New Haven, CT.

”

Abigail's second husband was John Miles, whose findagrave memorial (<https://www.findagrave.com/memorial/28364373/john-miles> ) reads as follows.

“

MY MILES FAMILY~

The son of my ancestors, [CAPT. JOHN MILES](#) and [ELIZABETH \(HARRIMAN\) MILES](#), he married Hannah Prindle in 1687 in New Haven Colony.

Their son: [Major Thomas Miles](#)

---

Donald Lines Jacobus's article "Captain John Miles the Weaver, Ancestor of the Wallingford and Goshen, Conn., Families," in *The American Genealogist* (vol. 35 [October 1959], p. 247-55), established that Capt. John Miles who was buried at Grove Street Cemetery in New Haven

## Tracing Ellen's mtDNA

was all but certainly \*not\* the same man as Capt. John<sup>3</sup> Miles, son of John<sup>2</sup>, grandson of Richard<sup>1</sup> Miles, the 1639 emigrant to New Haven from Great Munden, Hertfordshire. Capt. John<sup>3</sup> Miles moved to Elizabethtown, New Jersey and died there in 1708.

Capt. John Miles who died 10 Feb 1709/10 and was buried at Grove Street Cemetery was variously called "weaver" and "clothier" in New Haven records. By a first wife whose identity is unknown, he had four sons:

- 1) Maj. Thomas Miles (c1682–1741), m. Abigail Mix
- 2) John Miles (c1684–1760), m. Sarah Ball
- 3) Joseph Miles, presumably the man who m. Jane Bowden 19 Nov 1718 in Newtown, Conn.
- 4) a fourth son whose name is unknown.

By 1694, John Miles the weaver married as his second wife Abigail (Thompson) Alsop, widow of Joseph Alsop, who had died 12 Jan 1690/1.

Contributor:

Derek Wood - [derekwood@gmx.com](mailto:derekwood@gmx.com)

”

## Tracing Ellen's mtDNA

### Rebecca Thompson Thomas b. 1651 d. 1716

Married Daniel  
Thomas b. 1647.

They had daughters  
named . . .  
Dorothy,  
Dinah,  
Recompence,  
Experience.

You have to love  
the names of this  
period!

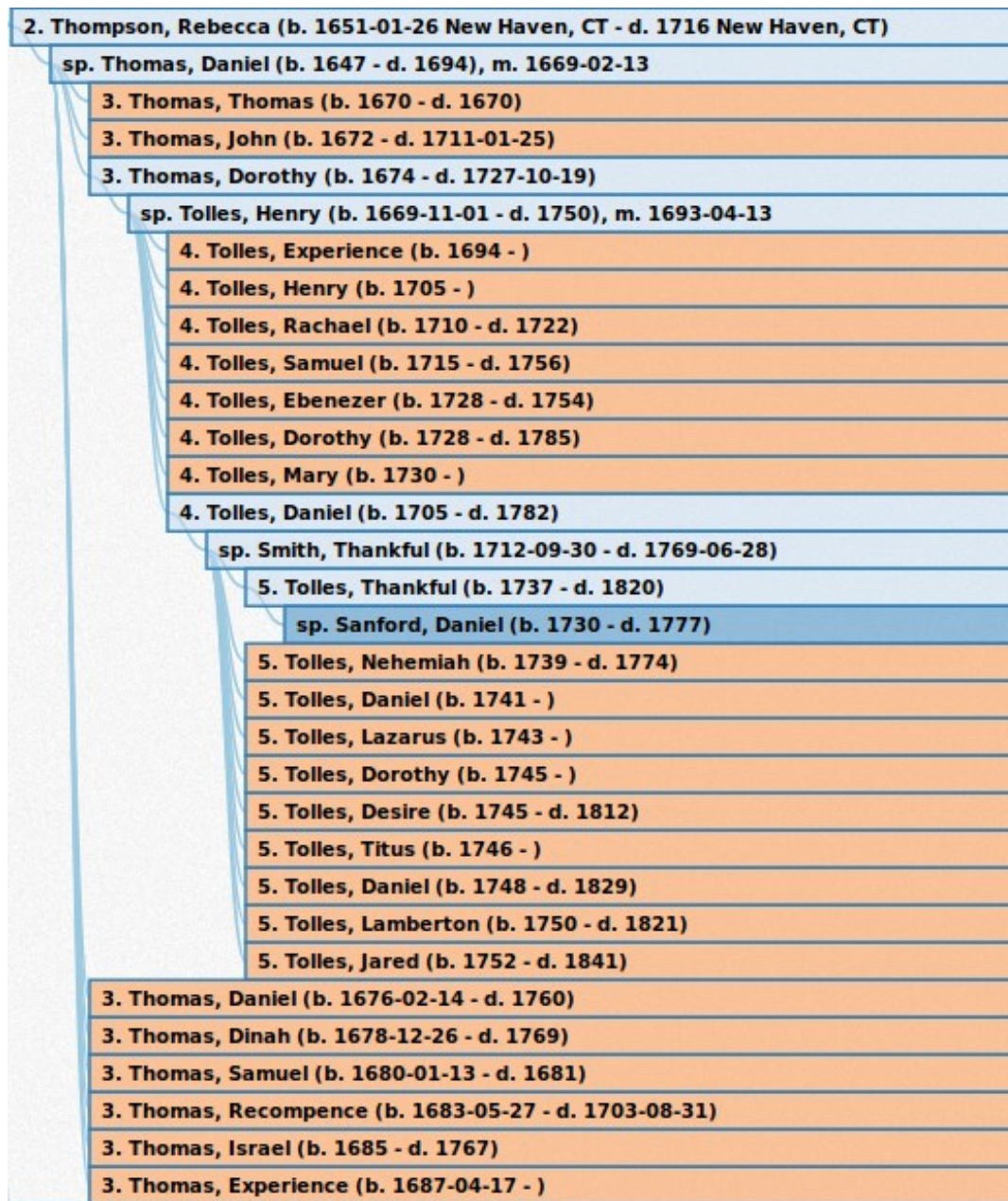

## Tracing Ellen's mtDNA

### **Dorothy Thomas Tolles b. 1674 d. 1727**

Following Dorothy's line brings us first to Experience Tolles, then Rachel, Dorothy, and Mary

**Father/partner1**

Name: Tolles, Henry [I1579]  
Birth: 1669-11-01  
Death: 1750

**Mother/partner2**

Name: Thomas, Dorothy [I1550]  
Birth: 1674  
Death: 1727-10-19

**Relationship Information**

ID:  Type:

Tags:

**Children**

#	ID	Name	Gender	Paternal	Maternal	Birth Date
1	I1580	Tolles, Experience	female	Birth	Birth	1694
2	I1581	Tolles, Henry	male	Birth	Birth	1705
3	I1582	Tolles, Rachael	female	Birth	Birth	1710
4	I1583	Tolles, Samuel	male	Birth	Birth	1715
5	I1584	Tolles, Ebenezer	male	Birth	Birth	1728
6	I1585	Tolles, Dorothy	female	Birth	Birth	1728
7	I1586	Tolles, Mary	female	Birth	Birth	1730
8	I1587	Tolles, Daniel	male	Birth	Birth	1705

### **Experience Tolles Osborne b. 1694 d. 1737**

And Experience leads to her first daughter Esther. (below)

**Father/partner1**

Name: Osborne, Joseph [I1763]  
Birth: 1694-02-18  
Death: 1724

**Mother/partner2**

Name: Tolles, Experience [I1580]  
Birth: 1694  
Death: 1737

**Relationship Information**

ID:  Type:

Tags:

**Children**

#	ID	Name	Gender	Paternal	Maternal	Birth Date
1	I1764	Osborne, Daniel	male	Birth	Birth	1715
2	I1765	Osborne, Joseph	male	Birth	Birth	1718
3	I1766	Osborne, Amos	male	Birth	Birth	1722
4	I1767	Osborne, Esther	female	Birth	Birth	1721

## Tracing Ellen's mtDNA

### **Esther Osborne Booth b. 1721 d. ?**

Daughter Esther had just a daughter, Elizabeth – born in Fairfield Co., CT. However there is confusion in the compiled records about another daughter named Betsy, who might actually be Elizabeth. If they are the same person, she likely married Hezekiah Sanford (?-1834?) and eventually died in Hartford Co., CT.

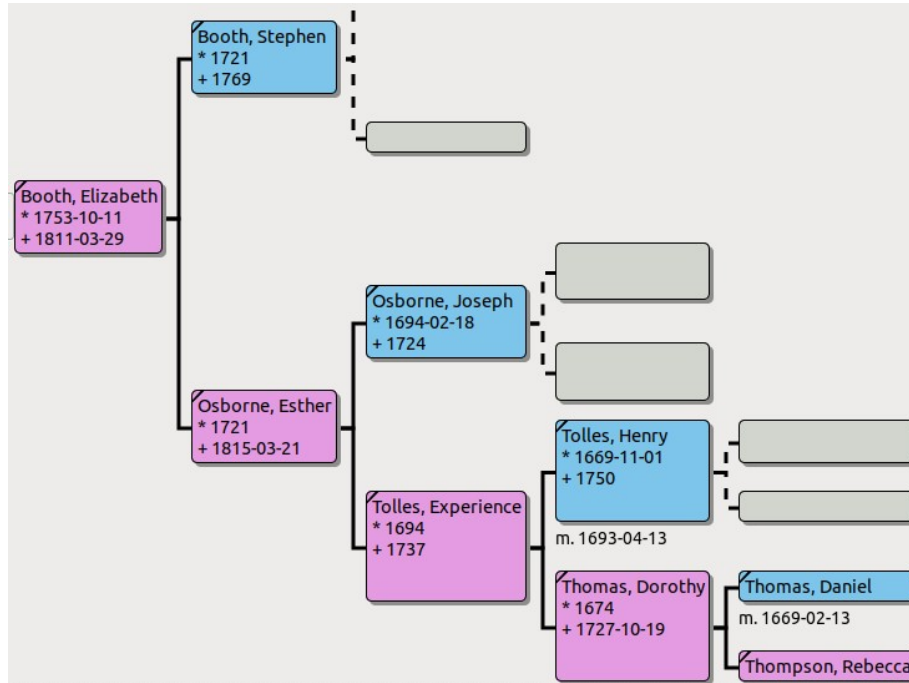

## Tracing Ellen's mtDNA

### **Rachel Tolles Ruggles b. 1710 d. 1746**

Rachel's daughters appear to have been Lois, Rachel, Mercy, and Mabel.

### **Lois Ruggles Warner b. 1721 d. 1781**

I have followed Lois b. 1721 and believe that all of her daughters married. The following findagrave memorial provides some hints about these daughters.

Lois Ruggles Warner

Birth: 2 Apr 1727 New Haven, New Haven County, Connecticut, USA

Death: 14 Oct 1781 (aged 54) New Milford, Litchfield County, Connecticut, USA

Burial: Gallow Hills Cemetery, New Milford, Litchfield County, Connecticut, USA

Plot:

Memorial #: 17536832

Bio: Father Joseph Ruggles 1701-1791 Mother Rachel Tolles 170513 RUGGLES siblings: Samuel, Elizabeth, Mary, Sarah, Rachel, Mercy, Mable, Timothy, Benjamin, Joseph, Ashbel, Lucy, Anna.

Lois married Oliver Warner on 10/16/1751.

Children:

1. Lucy Warner (9/17/1752-8/22/1799); m. 1) Ichabod Bostwick on 2/27/1771, m. 2) Nathaniel Dickee....3 BOSTWICK children: ...1.Lois Ann Bostwick 1772...2.Sally Bostwick 1772...3.Oliver Bostwick 1776

2. Tryphene Warner (12/14/1753-6/16/1815); m. Benjamin Starr Mygatt (1746-2/6/1794) on 4/5/1775. BENJAMIN: #11571978

3.Mabel Warner(9/20/1757-5/3/1801); m.Daniel Nobel Carrington on 6/19/1802....2 CARRINGTON children:...1. Mary Carrington ...2. Lucy Carrington Memorial: #40451251

4. Reuben Warner (5/23/1759-11/14/1825); m. Eunice Carrington....1 WARNER child known: William R. Warner Memorial: #25892381

5. Prudence Warner B-8/28/1761; m. ( ) Couch.

6. Tamar Warner B-7/20/1764; m. ( ) Beach\_\_\_\_\_Andrew-1 Warner lineage.

Inscription: In memory of Lois, wife of Oliver Warner, who Died Oct 14th 1781 in the 55th year of her age

Family Members

## Tracing Ellen's mtDNA

### Parents

Joseph Ruggles 1701-1791

### Spouse

Oliver Warner 1729-1814

### Siblings

Joseph Ruggles 1728-1802

Lazarus Ruggles 1730-1797

Rachel Ruggles Bishop 1732-1800

Mercy Ruggles Bostwick 1732-1822

Mabel Ruggles Bostwick 1736-1804

Ashbel Ruggles 1739-1814

### Children

Reuben Warner 1759-1825

Maintained by: Find A Grave (8)

Originally Created by: eobfindagrave (46779688)

Added: 17 Jan 2007

URL: <https://www.findagrave.com/memorial/17536832/lois-warner>

Citation: Find A Grave, database and images (<https://www.findagrave.com> : accessed 12 February 2019), memorial page for Lois Ruggles Warner (2 Apr 1727–14 Oct 1781), Find A Grave Memorial no. 17536832, citing Gallow Hills Cemetery, New Milford, Litchfield County, Connecticut, USA ; Maintained by Find A Grave (contributor 8) .

### **Rachel Ruggles Bishop b. 1732 d. 1800**

Following Rachel has led to the following findagrave entry that indicates that she died in Vermont, after having a number of daughters (all who married).

Rachel Ruggles Bishop

Birth: 7 Jul 1732 New Haven, New Haven County, Connecticut, USA

Death: 1800 (aged 67–68) Monkton Ridge, Addison County, Vermont, USA

Burial: Unknown

Memorial #: 128309195

Bio: "Royal Families: Americans of royal and noble ancestry" 2nd Edition, p.259, shows Rachel(Ruggles) Bishop died after the census of 1800 in Monkton, Addison County, Vermont. The two likely cemeteries are Monkton Boro Cemetery and Monkton Ridge Cemetery.

## Tracing Ellen's mtDNA

Monkton Ridge seems more likely as it bordered on the farm land owned by John and Rachel (Ruggles)Bishop.

### Family Members

#### Parents

Joseph Ruggles	1701-1791
Rachel Tolles Ruggles	1702-1746

#### Spouse

John Bishop	1730-1801
-------------	-----------

#### Siblings

Joseph Ruggles	1728-1802
Mercy Ruggles Bostwick	1732-1822
Mabel Ruggles Bostwick	1736-1804
Ashbel Ruggles	1739-1814

#### Half Siblings

Lois Ruggles Warner	1727-1781
Lazarus Ruggles	1730-1797

#### Children

Rachel Bishop Curtis	1752-1841
John Bishop	1757-1801
Ruby Bishop Spalding	1759-1826
Elijah Bishop	1763-1839
Urania (Urane) Bishop Kellogg	1768-Unknown
Naphthali Bishop	1770-1849
Samuel Bishop	1772-1842

Created by: Chuck Templin (47502461)

Added: 21 Apr 2014

URL: <https://www.findagrave.com/memorial/128309195/rachel-bishop>

Citation: Find A Grave, database and images (<https://www.findagrave.com> : accessed 12 February 2019), memorial page for Rachel Ruggles Bishop (7 Jul 1732–1800), Find A Grave Memorial no. 128309195, ; Maintained by Chuck Templin (contributor 47502461) Unknown.

### **Mercy Ruggles Bostwick b. 1732 d. 1822**

Another findagrave entry (for Mercy) indicates that she married Edwin Bostwick. They had no daughters according to this reference.

<https://www.findagrave.com/memorial/103254453/mercy-bostwick>



## Tracing Ellen's mtDNA

### **Mabel Ruggles Bostwick b. 1736 d. 1804**



<https://www.findagrave.com/memorial/120371848/mabel-bostwick> is a reference that indicates that Mabel had three daughters. Only one survived to marry. This survivor was named Lois and she married a man named Bildad Hine. (I did not make that up!) They are buried in Trumbull Co., OH.

## Tracing Ellen's mtDNA



### **Dorothy Tolles Bristol b. 1711 d. 1785**

This marriage produced three daughters for us to follow.

(By the way, the Bristol line figures into my maternal line another way – see Huldah Nichols' ancestors.)

**Father/partner1**  

Name: Bristol, Stephen [I1780]  
Birth: 1707  
Death: 1785







**Mother/partner2**  

Name: Tolles, Dorothy [I1585]  
Birth: 1711  
Death: 1785-08-14

**Relationship Information**

ID:  Type:

Tags:

**Children**      

#	ID	Name	Gender	Paternal	Maternal	Birth Date
1	I1781	Bristol, Stephen	male	Birth	Birth	1734
2	I1782	Bristol, Ichabod	male	Birth	Birth	1736
3	I1783	Bristol, Abner	male	Birth	Birth	1738
4	I1784	Bristol, Rachel	female	Birth	Birth	1739-12-11
5	I1785	Bristol, David	male	Birth	Birth	1742
6	I1786	Bristol, Dorothy	female	Birth	Birth	1748
7	I1787	Bristol, Dinah	female	Birth	Birth	1751

### **Rachel Bristol Smith Downs b. 1739 d. 1817**

Rachel seems to have been married twice. The second marriage to Samuel Downs produced two sons and no daughters. The first marriage to David Smith produced two daughters – Mabel (b. 1760 d. 1852) and Esther (b. 1762 d. 1846).

Mabel appears to have married Noah Alling (1757-1848). We have seen the Alling family before!

The Alling family looks to have been popular with Esther as well. She married Roger Alling (1762-1840).

### **Dorothy Bristol Thomas b. 1748 d. 1834**

Dorothy Married one Samuel Thomas (b. 1750). Their children included two daughters: Susanah (1790-1795) and Statira (1794-?) - according to a family tree on ancestry.com at least.

### **Dinah Bristol Candee b. 1751 d. 1785**

Dinah and her husband David (1747-1841) may have had a fairly large family that included daughters Dinah, Lucena, Lucinda, Polly, and Esther. I have not tracked any of these daughters.

## Tracing Ellen's mtDNA

### ***Mary Tolles b. 1730 d. 1731?***

I can find no evidence that Mary ever married. One unsourced tree indicates that she died in 1731, which would account for the null result. It may be that she is being confused with another Mary Tolles born in 1729 of different parents (Henry Tolles and Mary Goodsell). I'm going to speculate that this is a mtDNA dead end.

## Tracing Ellen's mtDNA

### Dinah Thomas Sherman b. 1678 d. 1769

Dinah most likely had three daughters – Lydia, Dinah, and Elizabeth.

Father/partner1		Mother/partner2				
Name:	Sherman, John [I1788]	Name:	Thomas, Dinah [I1574]			
Birth:	1673	Birth:	1678-12-26			
Death:	1727	Death:	1769			
<b>Relationship Information</b>						
ID:	<input type="text" value="F0445"/>	Type:	<input type="text" value="Married"/>			
Tags:						
<b>Children</b>   Events   Source Citations   Attributes   Notes   Gallery   LDS						
+   [Icons]						
#	ID	Name	Gender	Paternal	Maternal	Birth Date
1	I1789	Sherman, Lydia	female	Birth	Birth	1699-12-20
2	I1790	Sherman, Dinah	female	Birth	Birth	1702-10-27
3	I1791	Sherman, Samuel	male	Birth	Birth	1704-02-01
4	I1792	Sherman, Elizabeth	female	Birth	Birth	1708-01-25

Some researchers have confused this New haven family with another Sherman family in Fairfield Co. headed by Daniel, not John Sherman.

## Tracing Ellen's mtDNA

### **Lydia Sherman Todd b. 1699 d. 1733**

Lydia Sherman's daughters, all born in the New Haven Co., CT, area were Lydia, Lois, and Eunice.

**Father/partner1**

Name: Todd, James [I1795]  
 Birth: 1696  
 Death: 1779

**Mother/partner2**

Name: Sherman, Lydia [I1789]  
 Birth: 1699-12-20  
 Death: 1733-09-17

**Relationship Information**

ID:  Type:

Tags:

**Children** **Events** **Source Citations** **Attributes** **Notes** **Gallery** **LDS**

#	ID	Name	Gender	Paternal	Maternal	Birth Date
1	I1796	Todd, Ebenezer	male	Birth	Birth	1722
2	I1797	Todd, James	male	Birth	Birth	1725
3	I1798	Todd, Lydia	female	Birth	Birth	1727-07-06
4	I1799	Todd, Lois	female	Birth	Birth	1729-11-10
5	I1800	Todd, Eunice	female	Birth	Birth	1732-06-10

### **Lydia Todd Smith b. 1727 d. 1819**

Married James Smith and had daughters Mary and Mabel.

Mary married James Pardee (1746-1827) in 1772. They had a number of daughters that may have included: Polly, Sarah, Mabel, Martha, and Isabel. It appears that they stayed in the New Haven Co., CT, area.

Mabel married Merriman Munson

**Father/partner1**

Name: Smith, James [I1801]  
 Birth: 1713  
 Death: 1805

**Mother/partner2**

Name: Todd, Lydia [I1798]  
 Birth: 1727-07-06  
 Death: 1819-09-14

**Relationship Information**

ID:  Type:

Tags:

**Children** **Events** **Source Citations** **Attributes** **Notes** **Gallery** **LDS**

#	ID	Name	Gender	Paternal	Maternal	Birth Date
1	I1802	Smith, Mary	female	Birth	Birth	1747
2	I1803	Smith, James	male	Birth	Birth	1750
3	I1804	Smith, Benjamin	male	Birth	Birth	1753
4	I1805	Smith, John	male	Birth	Birth	1756
5	I1806	Smith, Thomas	male	Birth	Birth	1761
6	I1807	Smith, Eli	male	Birth	Birth	1764
7	I1808	Smith, Mabel	female	Birth	Birth	1769

(b. ? d. 1818). According to a findagrave memorial, they had three children – two males and one

## Tracing Ellen's mtDNA

female. The one daughter, Mary was born in 1804 and married a John Cook (1799-1858). They lived in New Haven Co., CT, and they had a family that included two daughters.

### **Lois Todd Turner b. 1729 d. 1812**

Lois married James Turner (1727-1788). Their family consisted of three daughters: Lois, Mary, and Dorcas.

**Father/partner1** **Mother/partner2**

Name: Turner, James [I1813]      Name: Todd, Lois [I1799]  
Birth: 1727      Birth: 1729-11-10  
Death: 1788      Death: 1812-09-27

**Relationship Information**

ID:       Type:

Tags:

**Children**

#	ID	Name	Gender	Paternal	Maternal	Birth Date
1	I1814	Turner, Lois	female	Birth	Birth	1748-10-12
2	I1815	Turner, Bethuel	male	Birth	Birth	1751
3	I1816	Turner, Mary	female	Birth	Birth	1754-04-17
4	I1817	Turner, Dorcas	female	Birth	Birth	1756-09-30
5	I1818	Turner, Bethuel	male	Birth	Birth	1761

Records indicate that Lois (1748-1776) married one James Ives (1751-1826) and that they had one daughter, Bede, who survived and married Jared Goodyear.

Mary (1754-1829) married Hezekiah Tuttle (1749-1835) and they had many children, apparently including just one daughter, Lydia (b.1783 d. 1862?), who may have married one Amos Abbey.

Dorcas (1756-1831) married Samuel Thorpe (?-1820). They also had many children in their family in New haven Co., CT. Here is a list of daughters: Chloe (1779-?), Patience (1780-?), Lowly (1786-1858), Rhoda (1789-?), Sally (1794-1795). I have not traced any of these daughters.

## Tracing Ellen's mtDNA

### **Eunice Todd Gilbert b. 1732 d. 1832**

Eunice may have married John Gilbert (1731?-1779?), but there is some confusion that may stem from the existence of two John Gilberts and/or two wives (Eunice Todd versus Lydia Ives). I was not able to sort out the conflicting views of history.

What I present here is the version in which Eunice Todd married John Gilbert and built a family in New Haven Co., CT, consisting of six children, four of whom were daughters.

The screenshot shows a genealogy software interface. At the top, there are two columns: "Father/partner1" and "Mother/partner2". Under "Father/partner1", the name is "Gilbert, John [I0000]", birth is "1731", and death is blank. Under "Mother/partner2", the name is "Todd, Eunice [I1800]", birth is "1732-06-10", and death is "1823". Below this is a "Relationship Information" section with "ID: F0450" and "Type: Unknown". There are tabs for "Children", "Events", "Source Citations", "Attributes", "Notes", "Gallery", and "LDS". The "Children" tab is active, showing a table of six children.

#	ID	Name	Gender	Paternal	Maternal	Birth Date
1	I1794	Gilbert, Sarah	female	Birth	Birth	1758-08-26
2	I1819	Gilbert, Eunice	female	Birth	Birth	1762-02-20
3	I1821	Gilbert, John	male	Birth	Birth	1764
4	I1822	Gilbert, Mabel	female	Birth	Birth	1767-05-10
5	I1820	Gilbert, Lydia	female	Birth	Birth	1769-01-29
6	I1823	Gilbert, Julius	male	Birth	Birth	1771

Sarah Gilbert (1758-?) - It seems clear that Sarah was a daughter of Eunice and John. However, I can find no clear evidence of her marriage or death. She would be easily confused with Sarah Gilbert (b. 9/9/1758) to Hezekiah Gilbert and his with Tameson Gregory in Fairfield Co., CT. More research could be done on this.

Eunice Gilbert (1762-1835) married Jesse Tuttle (1759-1848). I did not look for any offspring that they may have produced.

Consensus opinion is that Mabel Gilbert (1767) married Ezra Munson (1757-1800). Their family located in new haven, CT, consisted of Lydia, Harriet, Austin, Chauncy, Justus, and Kezia.



Lydia Gilbert (1769-1774) died quite early in life.

## Tracing Ellen's mtDNA

### ***Dinah Sherman Atwater b. 1702 d. 1739***

The marriage of Dinah Sherman and James Atwater looks like the right one to follow in this case.

The Atwater/Sherman family likely had six children – James, Abigail (1727-?), Elijah (2x?), Lydia (1734-?), and Rachel (1737-?). Note that after Dinah's death in 1739, James must have married Elizabeth Alling. Following the daughters of the first marriage yields one more generation . . .

**Father/partner1**  **Mother/partner2** 







Name: Atwater, James [I1826]      Name: Sherman, Dinah [I1790]  
Birth: 1698      Birth: 1702-10-27  
Death: 1766      Death: 1739-12-19

**Relationship Information**

ID:       Type:

Tags:

**Children**  **Events** **Source Citations** **Attributes** **Notes** **Gallery** **LDS**

#	ID	Name	Gender	Paternal	Maternal	Birth Date
1	I1827	Atwater, James	male	Birth	Birth	1724
2	I1828	Atwater, Abigail	female	Birth	Birth	1727-11-19
3	I1829	Atwater, Elijah	male	Birth	Birth	1730
4	I1830	Atwater, Elijah	male	Birth	Birth	1732
5	I1831	Atwater, Lydia	female	Birth	Birth	1734-08-25
6	I1832	Atwater, Rachel	female	Birth	Birth	1737-04-26



## Tracing Ellen's mtDNA

### Abigail Atwater Peck b. 1727 d. ?

Abigail married Nicholas Peck (1732-1793) in New haven in 1753 and they had the following female children.

Father/partner1		Mother/partner2	
Name: Peck, Nicholas [11833]	Birth: 1732	Name: Atwater, Abigail [11828]	Birth: 1727-11-19
Death: 1793		Death:	

**Relationship Information**

ID:  Type:

Tags:

**Children** | **Events** | Source Citations | Attributes | Notes | Gallery | LDS

#	ID	Name	Gender	Paternal	Maternal	Birth Date
1	I1834	Peck, Abigail	female	Birth	Birth	1754-12-13
2	I1835	Peck, Mary	female	Birth	Birth	1758-08-27
3	I1836	Peck, Pamela	female	Birth	Birth	1761-01-25
4	I1837	Peck, william	male	Birth	Birth	1763
5	I1838	Peck, Elijah	male	Birth	Birth	1765
6	I1839	Peck, Mary	female	Birth	Birth	1767-10-31
7	I1840	Peck, Sarah	female	Birth	Birth	1770-03-10

### Abigail Peck Cook b. 1754 d. 1787

Abigail was married to Joseph Cook, but she died quite early in life in Dutchess Co., NY. "She was his first wife. Children were: Hannah, William, Elizabeth, Simeon, Lucy, Zena and Lyman David. She is buried next to Lucy and child of Joseph and second wife, Olive." - From findagrave memorial <https://www.findagrave.com/memorial/23416867/cook#clipboard> .

### Mary Peck b. 1758 d. ?

I can find no clear records for Mary other than the record of her birth. More research is needed.

### Pamela Peck b. 1761 d. ?

I can find no clear records for Pamela. Just one pedigree submission mentions her. - "Pedigree Resource File," database, *FamilySearch* (<https://familysearch.org/ark:/61903/2:2:SBQK-7FM> : accessed 15 February 2019), entry for Pamela /Peck/; file (2:2:2:MM7Y-Z63), submitted 14 May 2011 by shalom [identity withheld for privacy].

### Mary Dinah Peck b. 1767

I can find no clear records for this Mary other than the record of her birth, which shows her name as Mary Dinah. More research is needed.

## Tracing Ellen's mtDNA

Sarah b. 1770 d. 1770

### **Lydia Atwater b. 1734 d. 1748?**

There are at least 3 death records for a person named Lydia Atwater. Assuming that one is accurate, it is reasonable to assume Lydia died before she could have been responsible for any daughters.

### **Rachel Atwater Bradley b. 1737 d. 1809**

A findagrave memorial indicates that Rachel married Jonah Bradley (1732-1814). They had two daughters – Betsy M. Bradley Sanger and Sarah Bradley Viall. These were New haven families, except for that of Sarah, who ended up in Onondaga Co., NY.

## Tracing Ellen's mtDNA

### **Elizabeth Sherman Gilbert b. 1708 d. 1738**

Elizabeth married Stephen Gilbert on 6/26/1729. They lived in New haven, CT.

They had just one daughter, who married David Potter in 1748.

**Father/partner1** -

Name: Gilbert, Stephen [I1844]  
 Birth: 1708  
 Death: 1754

**Mother/partner2** -

Name: Sherman, Elizabeth [I1792]  
 Birth: 1708-01-25  
 Death: 1738-09-17

**Relationship Information**

ID:  Type: Married

Tags:

**Children** Events Source Citations Attributes Notes Gallery LDS

+ -

#	ID	Name	Gender	Paternal	Maternal	Birth Date
1	I1845	Gilbert, Stephen	male	Birth	Birth	1732
2	I1846	Gilbert, Moses	male	Birth	Birth	1735
3	I1847	Gilbert, Sarah	female	Birth	Birth	1730-04-10
4	I1848	Gilbert, Abel	male	Birth	Birth	1737

### **Sarah Gilbert Potter b. 1730 d. 1798**

Sarah Gilbert married David Potter and they had two daughters – Elizabeth and Sarah.

**Father/partner1** -

Name: Potter, David [I1849]  
 Birth: 1717-11-26  
 Death: 1773-11-26

**Mother/partner2** -

Name: Gilbert, Sarah [I1847]  
 Birth: 1730-04-10  
 Death: 1798

**Relationship Information**

ID: F0457 Type: Married

Tags:

**Children** Events Source Citations Attributes Notes Gallery LDS

+ -

#	ID	Name	Gender	Paternal	Maternal	Birth Date
1	I1850	Potter, Abel	male	Birth	Birth	1749
2	I1851	Potter, David	male	Birth	Birth	1751
3	I1852	Potter, Samuel	male	Birth	Birth	1759
4	I1853	Potter, Elizabeth	female	Birth	Birth	1754
5	I1854	Potter, Sarah	female	Birth	Birth	1756

## Tracing Ellen's mtDNA

Elizabeth Potter Ford b. 1754 d. 1817

Elizabeth Potter married Stephen Ford. They had three daughters and three sons as shown in the picture.

Anna married Nehemiah Bradley, who later married Anna's sister, Rachel.

I'm not sure what became of Elizabeth Ford.

**Father/partner1**

Name: Ford, Stephen [I1855]  
Birth: 1749  
Death: 1843

**Mother/partner2**

Name: Potter, Elizabeth [I1853]  
Birth: 1754  
Death: 1817-01-06

**Relationship Information**

ID:  Type:

Tags:

**Children** Events Source Citations Attributes Notes Gallery LDS

#	ID	Name	Gender	Paternal	Maternal	Birth Date
1	I1856	Ford, Anna	female	Birth	Birth	1778
2	I1857	Ford, Stephen	male	Birth	Birth	1776
3	I1858	Ford, Nathaniel	male	Birth	Birth	1781
4	I1859	Ford, Elizabeth	female	Birth	Birth	1783
5	I1860	Ford, Rachel	female	Birth	Birth	1786
6	I1861	Ford, Lyman	male	Birth	Birth	1789

Sarah Potter b. 1756 d. 1790?

Sarah may have never married. There are indications that she died in 1790 in New Haven, Co., CT. I have seen no indication that she was ever married.

## Tracing Ellen's mtDNA

### **Recompence Thomas b. 1683 d. 1703**

It looks to me as if Recompence died at the age of about 20, without having any children. She lived in new Haven, CT.

### **Experience Thomas b. 1687 d. 1703**

Experience was about six years younger than her sister, Recompence, but it appears that they both died in the same year (1703), on the same day, if the records are accurate. Experience also lived in new haven and likely did not marry or have children.

## Tracing Ellen's mtDNA

### Mary Thompson Cooper b. 1652 d. ? \*

Mary married John Cooper, Jr, and they had a fairly large family in New Haven.

This is the line that leads to my family.

The first three children in this family did not survive long. Surviving daughters: in this generation of this line are . . . Sarah, Mary, Abigail, Hannah, and Rebecca.

**Father/partner1**

Name: Cooper, John Junior [I0098]  
 Birth: 1642-05-28  
 Death: 1703

**Mother/partner2**

Name: Thompson, Mary [I0099]  
 Birth: 1642-04-24  
 Death: 1714-11-17

**Relationship Information**

ID:  Type:

Tags:

**Children** **Events** **Source Citations** **Attributes** **Notes** **Gallery** **LDS**

#	ID	Name	Gender	Paternal	Maternal	Birth Date
1	I1230	Cooper, Rebecca	female	Birth	Birth	1666
2	I1500	Cooper, unknown	female	Birth	Birth	1668
3	I0097	Cooper, Mary	female	Birth	Birth	1669-11-15
4	I1038	Cooper, John	male	Birth	Birth	1670-02-23
5	I1039	Cooper, Sarah	female	Birth	Birth	1673-04-26
6	I1040	Cooper, Samuel	male	Birth	Birth	1675-06-20
7	I1501	Cooper, Mary	female	Birth	Birth	1677-09-04
8	I0120	Cooper, Abigail	female	Birth	Birth	1679-10-03
9	I1502	Cooper, Hannah	female	Birth	Birth	1681-08-10
10	I1041	Cooper, Joseph	male	Birth	Birth	1683-09-11
11	I0122	Cooper, Rebecca	female	Birth	Birth	1689-08-24

## Tracing Ellen's mtDNA

### **Sarah Cooper Munson b. 1673 d. 1736**

John Munson and Sarah married in New Haven in 1692 and had daughters Hannah, Amy, Ruth, Mehitabel, Sarah, and Elizabeth.

Father/partner1		Mother/partner2	
Name:	Munson, John [I1505]	Name:	Cooper, Sarah [I1039]
Birth:	1673	Birth:	1673-04-26
Death:	1749	Death:	1736

**Relationship Information**

ID:  Type:

Tags:

**Children** | **Events** | **Source Citations** | **Attributes** | **Notes** | **Gallery** | **LDS**

#	ID	Name	Gender	Paternal	Maternal	Birth Date
1	I1862	Munson, John	male	Birth	Birth	1693-07-07
2	I1864	Munson, Hannah	female	Birth	Birth	1697-02-09
3	I1506	Munson, Joel	male	Birth	Birth	1702-08-18
4	I1507	Munson, Amy	female	Birth	Birth	1704-09-18
5	I1508	Munson, Ruth	female	Birth	Birth	1708-01-30
6	I1865	Munson, Mehitabel	female	Birth	Birth	1709-10-17
7	I1866	Munson, Sarah	female	Birth	Birth	1713-09-27
8	I1863	Munson, Elizabeth	female	Birth	Birth	1716-02-28

### **Hannah Munson Andrews b. 1697 d. 1785**

It appears that Hannah was the last wife (the first being Lydia Johnson?) of Gideon Andrews. They may have married in 1739, and they may have had one child – Samuel (1742-?). I suspect that this branch of the mtDNA trail ends here.

### **Amy Munson Sperry b. 1704 d. ?**

Amy married Joshua Sperry in about 1727 in New Haven. Their children seem to have included the following daughters – Rebecca (1730-?), Amy (1732-1748), Phebe (1735-1756), Sarah (1739-1740), Thankful (1740/1741-?), and Rachel (1746-1748). The ones that might have had children are analyzed below.

### **Rebecca Sperry Osborn b. 1730 d. ?**

Rebecca Sperry married Jehiel Osborn (1728-?). They in turn had the following daughters –

- Amy (1750/1751-1761) did not live long enough to produce offspring.
- Rachel (1755-?) who married Michael Kenney,
- Lucy (1758-?) who married Zophar Atwater,

## Tracing Ellen's mtDNA

- Rebecca (1764-1842) who married Elijah Hotchkiss,
- and Elizabeth (1772-?) who married Harmon Payne.

### **Amy Sperry b. 1732 d. 1748**

Amy Sperry likely died in 1748 at about the age of 16. She shared a birthday (6/10) with her sister, Rebecca. I have found no marriage records, so I will assume that she had no children.

### **Phebe Sperry Downs b. 1735 d. ?**

Phebe married Joseph Downs in 1756. They had a family in new haven Co., CT. All children but two were male. One female was Phebe (1765-1844) and the other was Candace (1756-?). Both daughters married men with the surname of Downs (!) and stayed in the New Haven area.

### **Thankful Sperry b. 1740 d. 1740?**

I have found just the records of birth and baptism, separated by about 2 months. Other than this, there is no trace. I have a suspicion that this child did not survive long.



## Tracing Ellen's mtDNA

### ***Ruth Munson Hotchkiss b. 1708 d. 1785***

Ruth married Caleb Hotchkiss in 1728 in New Haven. They had four children, one of whom was a daughter – Esther (b.1745).

### **Esther Hotchkiss Murray b. 1745 d. 1831**

Esther married Philemon Murray and they had just one son, Hezekiah. This myDNA line ends here.

## Tracing Ellen's mtDNA

### ***Mehitabel Munson Morris b. 1709***

Benjamin Munson (b. 1699) married Mehitabel in November of 1731. They had three children – two of whom were female.

### **Sarah Morris b. 1737 d. 1829?**

Sarah married Judah Thompson and probably had just two children. One one a daughter named Rebecca Thompson (b. 1760). I can find no record of a marriage for this Rebecca, but I did find a potential death record – from phthisis (!) in 1829 in New Haven. I am inclined to accept this in lieu of other evidence. Taking that assumption, this branch of the mtDNA line end here.

### **Elizabeth Morris Humpreville b. 1739 d. ?**

It appears that in 1759 Elizabeth Morris married Thomas Humphreville (b. 1736) in New Haven Co., CT. Their children were Lemuel (1760-?), Thomas (1762-1850), Elijah (1764-?), Elizabeth (1766-1825) who married Ezra Lines (1760-1820), and Mehitabel (1770-1806) who apparently was never married.

## Tracing Ellen's mtDNA

### ***Sarah Munson Stone b. 1713 d. 1737***

Sarah married Enos Stone in 1731 and they had two children – Daniel (b. 1732) and Elizabeth (b. 1735).

### ***Elizabeth Stone b. 1735 d. ?***

I can find no record of what might have happened to Elizabeth. There are some potentially confusing similarly named people at this point in time. This is a line that could be investigated further.

### ***Elizabeth Munson Perkins b. 1695 d. ?***

Elizabeth married Seth Perkins (1685-1733) in 1716. Their children were Thomas (b. 1717), Amy and Eleanor.

### ***Amy Perkins Peck b. 1726 d. 1799***

Amy married Joseph Peck (1718-1788) in New haven. Their family consisted of the following. They mostly lived in the area of Woodbridge, CT.

Bathsheba Peck (1745-1832), who probably married Roswell Palmer (b. 1742)

Seth Peck (1747-1831)

Joseph Peck (1749-1800), who married Sarah Allcock (b. 1749)

Amy Peck (b.1751) who married Wilmot Bradley (1751-1814)

Dan Peck (b.1753)

John Peck (1756-1825), who married Lois Osborne.

Dorcas Peck (b.1758), who probably married William Osborne (b.1755).

Asenath Peck (1760-1838) , who married Stephen Russell (1756-1817)

Electa Peck (b.1761), who married John Alling (b.1761).

Henry Peck (b. 1764)

Rhoda Peck (1768-1770)



### ***Eleanor Perkins Hotchkiss b. 1726 d. 1816***

Eleanor married Solomon Hotchkiss (b.1724?) and lived in Woodbridge, CT. They had one daughter and two sons named Solomon (1752-1793) and David (1754-1823). Their daughter was Elizabeth Hotchkiss (b. 1749). Elizabeth married Daniel Johnson (b.1749).



## Tracing Ellen's mtDNA

### **Mary Cooper Smith b. 1677 d. 1761 \***

Samuel Smith and Mary Cooper headed another New haven Family. They were married in 1700. Their daughters were Obedience, Mary, Amy, Margaret, and Thankful.

**Father/partner1**  

Name: Smith, Samuel [I0096]  
Birth: 1678-05-14  
Death: 1753-08-22







**Mother/partner2**  

Name: Cooper, Mary [I1501]  
Birth: 1677-09-04  
Death: 1761-06-01

**Relationship Information**

ID:  Type:

Tags:

**Children**      

#	ID	Name	Gender	Paternal	Maternal	Birth Date
1	I1036	Smith, Lamberton	male	Birth	Birth	1701
2	I0119	Smith, Obedience	female	Birth	Birth	1705-05-19
3	I0117	Smith, Mary	female	Birth	Birth	1707-03-07
4	I1037	Smith, Amy	female	Birth	Birth	1708
5	I0094	Smith, Margaret	female	Birth	Birth	1711-06-26
6	I0118	Smith, Thankful	female	Birth	Birth	1712-09-30

### **Obedience Smith b. 1705 d. 1705**

The consensus among researchers is that Obedience died not long after birth in New Haven.

## Tracing Ellen's mtDNA

### **Mary Smith Painter b. 1707 d. 1786**

Mary married one Deliverance Painter (1701-1781) on 6/23/1775 in New Haven. There is a sad story about the death of Deliverance that you can see at his memorial -

<https://www.findagrave.com/memorial/66645028>. Their family consisted of the following, including five daughters. Of these five, it appears that only one (Mary) had any children. The family lived in New Haven Co., CT.

- Samuel b. 1726 d. 1748
- Mary b. 1728 d. 1804
- Amy b. 1730 d. 1751
- Thomas b. 1733 d. 1755
- Abigail b. 1738 d. 1755
- Lamberton b. 1740 d. 1795
- Rebecca b. 1744 d. 1788
- Freelove b. 1749 d. 1751

### **Mary Painter Mallory b. 1728 d. 1804**

Mary married Daniel Mallory (1720-?) in New Haven. It appears that they relocated to Litchfield Co., CT, where they had a large family that included the following daughters.

Abigail Mallory Curtiss (1748-?): Abigail married Israel Curtiss (1742-1802). They may have had a fairly large family, and they may have moved into Saratoga Co., NY. Their daughters included Polly (b. 1771), Charlotte (b. 1773), Mary (b. 1776), and Alatheia (b.1785).

Mary Mallory Curtiss (1749-10-17-?): I believe that Mary (like her sister) married a Curtiss (Stephen Curtiss 1744-1813) in Litchfield Co., CT. They also had a fairly large family, but most members stayed in CT. Her daughters included Amey (b. 1774), Mabel (b. 1778), Abigail (b. a780), Betsy (b.1783), Laura (b. 1790), and Louisa (b. 1792).

Note that there are two people named Mary Mallory/Mellery, living geographically very close (in Litchfield Co., CT), who are within a year of each other in age. The other Mary Mallory (b. 1748-06-23) was the daughter of John Mallory and probably Mary Sanford. She may have married a Simeon Minor (b. 1743) – who was also shadowed by a person with the same name in the same location but born about 7 years later.

## Tracing Ellen's mtDNA

Freelove Amy Osborne (1752-1794): Married Jared Osborne (1745-1832). They had four children, and their family stayed in the Oxford area of New Haven Co., CT. There was one daughter named Electa (b. 1793).

Lois Mallory Chatfield (1756-1790?): Lois married Eli Chatfield (1754-1840) in Oxford, New Haven, CT. There were six children, one of whom (Sherman) may have made it to Illinois. The daughters included Mary (b. 1778), Obedience (b. 1782), Lucinda (b. 1784), and Polly (b.1788).

Adah Mallory (Hitchcok?) (1762-?): There is confusion among researchers about who Adah may have married. – For now I choose Caleb Hitchcock, but that should be confirmed. If this is true, then their children included the following daughters: Polly, Huldah, Leusinia, Esther, Adah, and Phila.

Rebecca Mallory Osborne (1764–1846): There is evidence that Rebecca married Nathan Orborne (1763-1845). They may have had a large family and at some point moved to NY. This is worthy of more research.

Mabel Mallory (1765-?): I can find no clear evidence regarding what became of Mabel. It is clear that she was born on 11/17/1765 to Daniel and Mary in Litchfield Co., CT.

Pene Mallory (1767-?): It is clear that Pene was born on 9/9/1767 to Daniel and Mary in Litchfield, but I can find no evidence about the rest of her life.

### **Amy Painter b. 1730 d. 1751**

Died unmarried at only 21 years of age. She is buried in West Haven, New Haven, CT.

### **Abigail Painter b. 1738 d. 1755**

Died unmarried at only 16 years of age. She is buried with her sister in West Haven.

### **Rebecca Painter b. 1744 d. 1788**

I have seen in ancestry.com that there is suspicion that Rebecca married John Sherman (1734-1803). The evidence does appear to be strong, but if it is correct, they had just one child – Nathan Sherman (1767-1857). See [https://www.ancestry.com/family-tree/person/tree/151746240/person/342011163400/facts?\\_phsrc=VqT14&\\_phstart=successSource](https://www.ancestry.com/family-tree/person/tree/151746240/person/342011163400/facts?_phsrc=VqT14&_phstart=successSource) . This is the only hint that I have had about Rebecca's life.

### **Freelove Painter b. 1749 d. 1751**

This child died at about age 2 in West Haven, New Haven Co., CT.

## Tracing Ellen's mtDNA

### **Amy Smith b. 1709 d. ?**

It is clear that Amy was born 3/10/1709 in New Haven to Samuel Smith and Mary Cooper Smith. There is speculation that she died in 1709, or before 1715, or . . . . Her actual fate is unknown based on the evidence that I have seen. More work might be useful here.

### **Margaret Smith Smith(!) b. 1711 d. 1803 \***

Here the trail is much clearer. Margaret married Austin Smith (1711-1797) in New Haven, CT, on 2/7/1733. They share one set of great grandparents, namely George Smith (1618-1662) and his wife Sarah Bourne (1614-1683), so they were second cousins. Their offspring are listed below and the daughters' families are examined in following sections.

- Philena Smith Hickok(x) (1750-1826)
- Margaret Smith Thompson (1734-1821)
- Mary Smith (1737-1773)
- Gad Smith (1740-1786)
- Austin Smith (1742-?)
- Hannah Smith (1747-?)
- Anthony Smith (1752-1838)
- Mehitabel Smith Benham (1755-1834)

### **Margaret Smith Thompson b. 1734 d. 1821**

Margaret married Jonathan Thompson (1733-1784 ) in New haven Co., CT. Some researchers think that Jonathan's line can be traced back to the John Thompson that was Ellen's husband. There was another John Thompson in New Haven at the same time, however, and it seems more likely that this Jonathan Thompson's line leads back to him and his wife, Dorothy. This needs clarification, however. DNA analysis might ultimately be needed to separate of the Thompson lines (assuming that the two John Thompsons were not related).

In any event, Margaret and Jonathan had four children – Stephen (1759-?), Esther (1766-?), and Mary (?-1829).

Mary Thompson married David Hopkins. They lived in the Waterbury, CT, area and had a family that probably consisted of seven children, including three daughters (Polly, Mabel, and Laura).

## Tracing Ellen's mtDNA

### **Mary Smith (Thompson?) b. 1737 d. 1773**

There is speculation that Mary married Joel David Thompson (1737-1804). If that is the case, then there are a number of daughters to consider. This is VERY tentative, however. -

Mary (1763-?)

Sabra (1765-?)

Rachel (1767-?)

Asenath (1769-?)

Phebe (1773-?)

### **Hannah Smith Hickox b. 1746/1747 d. ?**

There is speculation that Hannah (1746-?) married James Hickox(k) (1746-1833) on 11/28/1766 in New Haven. They may have had a daughter named Olive (1744-1806), who married a man named John Bouton.



## Tracing Ellen's mtDNA

### **Philena Smith Hickox b. 1750 d. 1826 \***

In the context of autosomal DNA matching results, Philena's family represents a likely practical limit to which autosomal DNA matching could be expected to yield a match worth pursuing. Someone descended from one of her children could theoretically share about 0.1% of autosomal DNA with me or my mother. The statistical nature of inheritance, however, means that a living person who shares a most recent common ancestor from this family may share no DNA or a little more than 0.1%.

In any event, Philena married Gideon Hickox (sometimes spelled Hickok). His family is seen elsewhere in this document, so my ancestors were well acquainted with his family for some time. The marriage

Father/partner1		Mother/partner2	
Name:	Hickox, Gideon [I0040]	Name:	Smith, Philena [I0041]
Birth:	1752-05-04	Birth:	1750
Death:	1824-04-25	Death:	1826-11-17

**Relationship Information**

ID: F0015      Type: Married

Tags:

**Children**    Events    Source Citations    Attributes    Notes    Gallery    LDS

#	ID	Name	Gender	Paternal	Maternal	Birth Date
1	I0108	Hickox, David	male	Birth	Birth	1772-12-08
2	I0109	Hickox, Sara	female	Birth	Birth	1774-04-15
3	I0035	Hickox, Polly	female	Birth	Birth	1777-03-04
4	I1019	Hickox, Hannah Smith	female	Birth	Birth	1781-07-02

occurred on 8/29/1771 in Waterbury, New haven, CT.

There is evidence for just four children, all born in Waterbury. However, the family moved to Chenango Co., NY at some point. Chenango Co. is where Gideon and Philena are buried.

The families of their daughters and son are investigated below.

### **Sarah Hickox Beebe b. 1774 d. 1864**

Sarah married Orillana Beebe (1770-1863), probably in CT. His name is spelled in an assortment of ways. They moved to Cortland Co., NY, and probably had quite a few children. Sarah and Orillana are both buried there.

### **Polly Hickox Warner b. 1777 d. 1849 \***

Polly married Richard Warner while still in Waterbury in about 1792. They must have moved with her parents sometime between 1792 and 1802 based on the birth records for their children. My direct line maternal ancestor, Electa was born in Chenango Co., on 2/2/1802. It is her marriage to John Edwin

## Tracing Ellen's mtDNA

Robbins Jr. that produces the first first family for which I have some pictures. This Robbins/Warner family lived in Crawford Co., PA.

### ***Hannah Smith Hickox Terrill b. 1781 d. 1856***

Hannah married Elias Terrill (1766-1835) in New haven Co., CT, on 5/6/1798. They probably had a large family – some born in CT and others born in NY. (They eventually moved to Chenango Co., NY.

### ***David Hickox b. 1772 d. 1847***

David married Kezia Dutton (1783-1865), They lived in Litchfield Co., CT, and they had one son named Caleb.

## Tracing Ellen's mtDNA

### **Mehitabel Smith Benham b. 1755 d. 1834**

Mehitabel married Elihu Benham (1748-1836) . They lived in New haven Co., CT, and they had a family consisting of the following children (or something close to this?). (There is disagreement about the children.) Once again, this was a New Haven Family.

- Mehitabel (1773-?): married Zebah Farrell (1776-1862), had a family and remained in the New Haven Co., CT, area.
- Sally (1775-1862): She may have died 2/19/1862 in New Haven Co., CT. And, she may have been married to one Jacob Monroe on 3/12/1793.
- Elihu (1777-1862)
- Laurena (1785?-?): unknown fate.
- Leverett (1799-1851)
- Ransom (1790-1860)
- Philena (1791-?): unknown fate.
- Barzil (1795-1878)
- Lewis (1796-1885)
- Desire (1798-1803)

The information for this family is VERY tentative and could benefit form more research.

## Tracing Ellen's mtDNA

### **Thankful Smith Tolles b. 1712 d. 1769**

Thankful married Daniel Tolles (1705-1782) probably in the early 1730s. (Some people have confused her with her daughter, Thankful Tolles, who married Daniel Sanford. )

Thankful Smith and Daniel Tolles lived in New Haven Co., CT, where they may have had an impressive array of children. Estimates include the list of twelve in the accompanying picture.

Assuming this list is correct, there were four daughters to investigate: Thankful, Dorothy, Desire, and Mary.

**Father/partner1**

Name: Tolles, Daniel [I1587]  
 Birth: 1705  
 Death: 1782-06-20

**Mother/partner2**

Name: Smith, Thankful [I0118]  
 Birth: 1712-09-30  
 Death: 1769-06-28

**Relationship Information**

ID:  Type:

Tags:

**Children** Events Source Citations Attributes Notes Gallery LDS

#	ID	Name	Gender	Paternal	Maternal	Birth Date
1	I1588	Tolles, Thankful	female	Birth	Birth	1737
2	I1589	Tolles, Nehemiah	male	Birth	Birth	1739
3	I1590	Tolles, Daniel	male	Birth	Birth	1741
4	I1591	Tolles, Lazarus	male	Birth	Birth	1743
5	I1592	Tolles, Dorothy	female	Birth	Birth	1745
6	I1593	Tolles, Desire	female	Birth	Birth	1745
7	I1594	Tolles, Titus	male	Birth	Birth	1746
8	I1595	Tolles, Daniel	male	Birth	Birth	1748
9	I1596	Tolles, Lambertson	male	Birth	Birth	1750
10	I1597	Tolles, Jared	male	Birth	Birth	1752
11	I2064	Tolles, Abraham	male	Birth	Birth	1754
12	I2065	Tolles, Mary	female	Birth	Birth	1756

## Tracing Ellen's mtDNA

### Thankful Tolles Sanford b. 1737 d. 1820

This Thankful married Daniel Sanford. It appears that they were married in Waterbury and ended up in Litchfield Co., CT. Their last son (Eli) made it to Ashtabula, OH.

Daughters of interest follow.

**Father/partner1**

Name: Sanford, Daniel [I1598]  
 Birth: 1730  
 Death: 1777

**Mother/partner2**

Name: Tolles, Thankful [I1588]  
 Birth: 1737  
 Death: 1820

**Relationship Information**

ID:  Type:

Tags:

**Children**

#	ID	Name	Gender	Paternal	Maternal	Birth Date
1	I1600	Sanford, Irenah	female	Birth	Birth	1753-11-07
2	I2066	Sanford, Thankful	female	Birth	Birth	1755
3	I1601	Sanford, Ezekial	male	Birth	Birth	1757-11-25
4	I1602	Sanford, lois	female	Birth	Birth	1760-06-15
5	I1603	Sanford, Phoebe	female	Birth	Birth	1762-09-20
6	I1599	Sanford, Eli	male	Birth	Birth	1767-02-28

Irenah Sanford (1753-1830?): Irenah probably married Samuel Fenn (1743-1820) in 1767. There are multiple Samuel Fenns around at about this time, but this appears to be the correct one. That being the case, their children were likely included . . . Irena (1768-1830), Samuel (1770-1854), Eli (1772-1822), Thankful (1776-1829), and Anna (1778-?). Litchfield Co., CT, looks to have been their final home area.

Thankful Sanford (1755-1759): This Thankful did not survive long enough to have offspring.

Lois Sanford (1760-1832): Lois married Daniel Curtis (1754-1803) in 1776. They lived in Litchfield Co., CT, and had three children – Polly (1782-?), who married Isaac Newton (I did not make that up.), Eli (1786-?), and Philena (1779-?).

Phebe Sanford (1762-?): Phoebe married Samuel Martin (1759-?). They started in CT and eventually ended up in Broome Co., NY. Their children included these daughters: Fanny, Phebe, and Charlotte.

## Tracing Ellen's mtDNA

### **Dorothy Tolles b. 1745 d. 1745?**

I find nothing other than a record of Dorothy's baptism on 12/8/1745 in Nrew Haven Co., CT. My suspicion is that Dorothy was a twin to Desire and that Dorothy did not survive.

### **Desire Tolles Beecher b. 1745 d. 1812**

Desire married Isaac Beecher on 4/28/1768. They had a large family that included the following daughters Frances, Elizabeth, and Betsy. Some children, as well as Isaac ended up in Litchfield Co., CT.

### **Mary Tolles Thomas b. 1756 d. 1842**

Mary married Noah Thomas (1756-1818) in Oxford, CT., on 9/8/1781. They had six children, only one of which was female, namely Laura, who may have married Elihu Roninson.

## Tracing Ellen's mtDNA

### **Abigail Cooper Johnson b. 1679 d. 1724**

Abigail and her husband Isaac had just one daughter (Eunice). They were married in 1699 and lived in New Haven.

Father/partner1		Mother/partner2				
Name:	Johnson, Isaac [I1519]	Name:	Cooper, Abigail [I0120]			
Birth:	1672	Birth:	1679-10-03			
Death:	1750	Death:	1724-12-06			
<b>Relationship Information</b>						
ID:	<input type="text" value="F0393"/>	Type:	<input type="text" value="Married"/>			
Tags:						
<b>Children</b>   <b>Events</b>   Source Citations   Attributes   Notes   Gallery   LDS						
+   📄   📝   -   ⬆️   ⬇️						
#	ID	Name	Gender	Paternal	Maternal	Birth Date
1	I1520	Johnson, Eunice	female	Birth	Birth	1703
2	I1521	Johnson, David	male	Birth	Birth	1721











### ***Eunice Johnson (Sperry?) b. 1703 d. 1725***

Eunice died quite early in life (age 22). Only one source indicates that she may have married Asa Sperry, but I can find no confirmation of this. For now, I assume that Eunice died “without issue.”

## Tracing Ellen's mtDNA

### Hannah Cooper Lines b. 1681 d. 1772

Hannah and her husband John Lines had just one daughter (Kezia).



<b>Father/partner1</b>  	<b>Mother/partner2</b>  					
Name: Lines, John [I1497]	Name: Cooper, Hannah [I1502]					
Birth:	Birth: 1681-08-10					
Death:	Death: 1772-11-11					
<b>Relationship Information</b>						
ID: <input type="text" value="F0396"/>	Type: <input type="text" value="Married"/>					
Tags:						
<b>Children</b>      						
Events Source Citations Attributes  <b>Notes</b> Gallery LDS						
#	ID	Name	Gender	Paternal	Maternal	Birth Date
1	I1529	Lines, Kezia	female	Birth	Birth	1715-04-05



## Tracing Ellen's mtDNA

### **Kezia Lines Alling b. 1715 d. 1782**

Kezia (1715-1782) married Samuel Alling (1712/1715-1799) in about 1737 in New Haven. Their children consisted of those in the accompanying picture.

**Father/partner1**  **Mother/partner2** 

Name: Alling, Samuel [I1977]      Name: Lines, Kezia [I1529]  
Birth: 1715      Birth: 1715-04-05  
Death: 1788      Death: 1782-01-12

**Relationship Information**

ID:       Type:

Tags:

**Children**   Events   Source Citations   Attributes    Notes   Gallery   LDS

#	ID	Name	Gender	Paternal	Maternal	Birth Date
1	I1978	Alling, Ruth	female	Birth	Birth	1738-10-08
2	I1979	Alling, Roger	male	Birth	Birth	1741
3	I1980	Alling, Samuel	male	Birth	Birth	1743
4	I1981	Alling, Amos	male	Birth	Birth	1745
5	I1982	Alling, Kezia	female	Birth	Birth	1748-11-26
6	I1983	Alling, Cornelius	male	Birth	Birth	1748
7	I1984	Alling, Eleanor	female	Birth	Birth	1751-11-27
8	I1985	Alling, Hannah	female	Birth	Birth	1751-11-27
9	I1986	Alling, Gideon	male	Birth	Birth	1754
10	I1987	Alling, John	male	Birth	Birth	1756

### **Ruth Alling Hine b. 1738 d. 1777**

Daughter Ruth married Daniel Hine (1734-1798). Their daughters were Mary (1757-?), Kezia (1759-?), Rebecca (1760-?), Eunice (1760-?), Elizabeth (1765-?), and Hannah (1767-?). The history of this family seems a little confusing and poorly defined. The daughters warrant more research.

I have not found more data about Mary Hine (b. 1757). [She deserves more research.](#)

It appears that Kezia Hine married Timothy Goodrich (1756-1829). They ended up in VT.

Rebecca Hine (b. 1760) may have married a Hubbard person and moved to VT. She seems to be buried next to her sister, Elizabeth, in Rutland Co., VT. See memorial: <https://www.findagrave.com/memorial/46521466/elizabeth-hine> .

## Tracing Ellen's mtDNA

Eunice Hine (b. 1760) seems to have married Jonathan Orms. They lived in Rutland Co.,VT, and had a large family.

Elizabeth Hine likely was not married and died in VT. See info about her sister Rebecca above.

### **Kezia Alling b. 1748 d. 1765**

Daughter Kezia(h) died at about the age of 17 so I assume that she did not marry and so had no children. She was Cornelius' twin sister.

### **Eleanor Alling Frisbie b. 1751 d. ?**

Eleanor married Amos Frisbie. They lived in New Haven.

### **Hannah Alling Peck b. 1751 d. ?**

Hannah married Seth Peck. They also lived in the New Haven area. We have seen the Peck name elsewhere.

## Tracing Ellen's mtDNA

### Rebecca Cooper Alling b. 1689 d. 1770

Rebecca  
married  
Daniel Alling,  
and they had a  
daughter  
named Phebe.

Father/partner1		Mother/partner2				
Name: Alling, Daniel [11525]	Birth: 1688	Name: Cooper, Rebecca [10122]	Christening: 1689-08-24			
Death: 1756		Death: 1770-01-02				
<b>Relationship Information</b>						
ID: F0395	Type: Married					
Tags:						
<b>Children</b>   Events   Source Citations   Attributes   Notes   Gallery   LDS						
+   -   ↑   ↓						
#	ID	Name	Gender	Paternal	Maternal	Birth Date
1	I1526	Alling, Timothy	male	Birth	Birth	1712
2	I1527	Alling, Phebe	female	Birth	Birth	1723
3	I1528	Alling, Silas	male	Birth	Birth	1734-09-11

### *Phebe Alling Talmadge Wolcott b. 1723 d. 1788*

Phebe was married twice – first to Robert Talmadge in 1747 and then to William Wolcott sometime after 1754 by current estimates.

I can not find any children that Phebe had with Robert Talmadge (1715-1753). They were only married about 6 years before he died.

With William Wolcott (1730-1784) Phebe apparently had the following children, two of whom could have furthered the mtDNA line.

- Phebe (1755-1832)
- William (1756-1782)
- Eunice (1757-1759)
- Rebecca (1759-1838)
- Benajah (1762-1832)
- Timothy (1763-1767)

Father/partner1		Mother/partner2				
Name: Wolcott, William [11952]	Birth: 1736	Name: Alling, Phebe [11527]	Birth: 1723-03-24			
Death: 1788		Death: 1788-04-23				
<b>Relationship Information</b>						
ID:	Type: Married					
Tags:						
<b>Children</b>   Events   Source Citations   Attributes   Notes   Gallery   LDS						
+   -   ↑   ↓						
#	ID	Name	Gender	Paternal	Maternal	Birth Date
1	I1953	Wolcott, Phebe	female	Birth	Birth	1755-05-18
2	I1954	Wolcott, Willaim	male	Birth	Birth	1756-10-03
3	I1955	Wolcott, Eunice	female	Birth	Birth	1757
4	I1956	Wolcott, Rebecca	female	Birth	Birth	1759-08-19
5	I1957	Wolcott, Benajah	male	Birth	Birth	1762-04-07
6	I1958	Wolcott, Timothy	male	Birth	Birth	1763

## Tracing Ellen's mtDNA

### **Phebe Wolcott Barney b. 1755 d. 1832**

Here's a name that I have not encountered before – Barney. Phebe married Hanover Barney (1750-1839) in New Haven in 1775. They had the following children. It appears that the family stayed in the New Haven area.

- William (1777-1870)
- Silence (1770-1805) – married Elihu Munson (1774-1852)
- Anna (1781-?)
- Charles (1783-?)
- James (1785-?)
- Susan (1787-?)
- Lebbeus (1790-1795)
- Phebe (1792-?)
- Elizabeth (1794-?)
- Mary Ann (1799-?)

### **Rebecca Wolcott Turner b. 1759 d. 1838**

Rebecca married one Jabez Turner (1756-1846) in New haven in 1788. Their children are listed below. Some of these children probably migrated out of CT.

- Zina (?-?)
- Timothy (?-?)
- Jerusha (?-?)
- Beauajah (1779-1872)
- William (?-?)
- Bela (1788-1879)

## Tracing Ellen's mtDNA

### Sarah Thompson Alling b. 1654 d. 1716

Here is a list of Sarah's descendants for 3 generations.

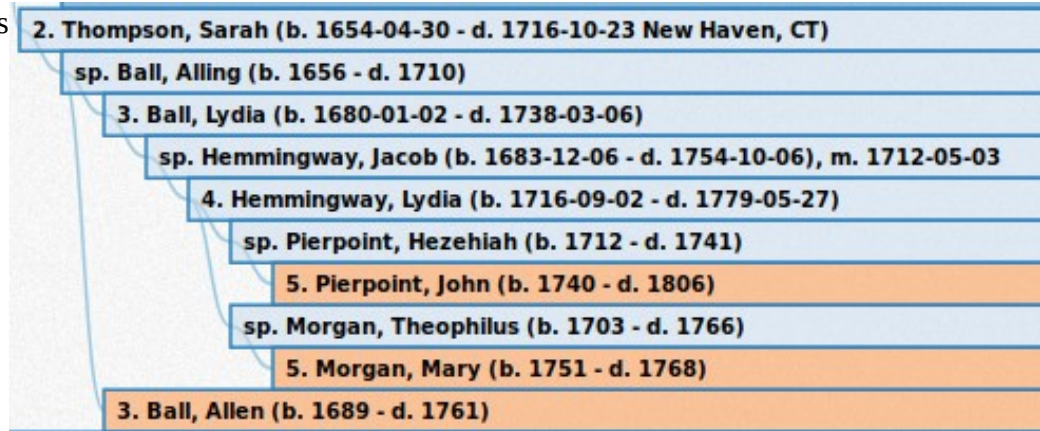

The end of the mtDNA line here is with Mary Morgan, who died at age 16 in Clinton, CT.

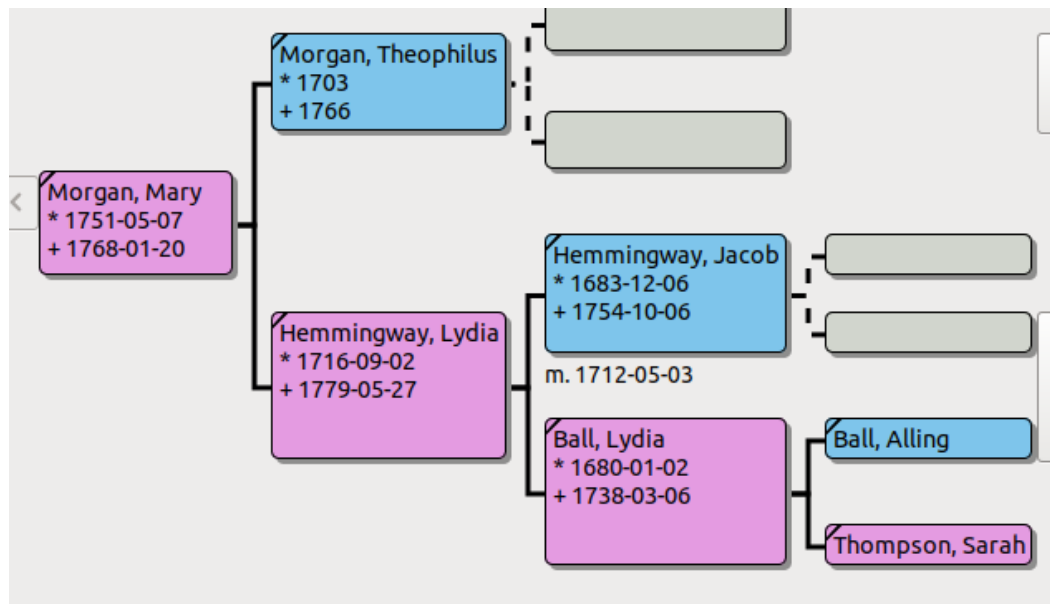

# Tracing Ellen's mtDNA

## Undocumented Lines (Dead-ends)

### Along Hannah Thompson's Line

#### The daughters of Mabel Russell and Benjamin Utter

They appear to have had two daughters, for whom I have found no descendants or death records. This was a family in East Haven, CT, which is where Mabel Russell seems to have been buried in 1782. These daughters are listed below.

Mary Utter b. 1737

Mabel Utter b. 1765

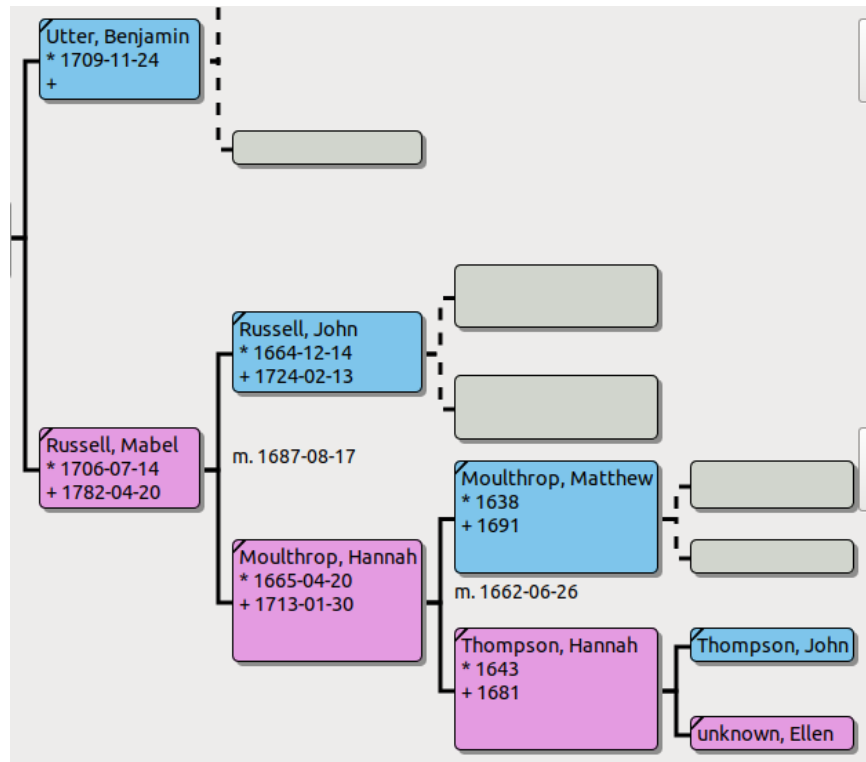

## Tracing Ellen's mtDNA

### Sarah Utter (b.1730), daughter of Lydia Russell (b. 1692) and Abraham Utter (b. 1688)

There is conflicting information about the fate of Sarah. She may have died within a year of birth or she may have married Phillip Knight of Rhode Island, where she died in 1759, after having two daughters – Phebe (b. 1756) and Sarah (b. 1757). Requires more careful research to get a better idea of the truth.

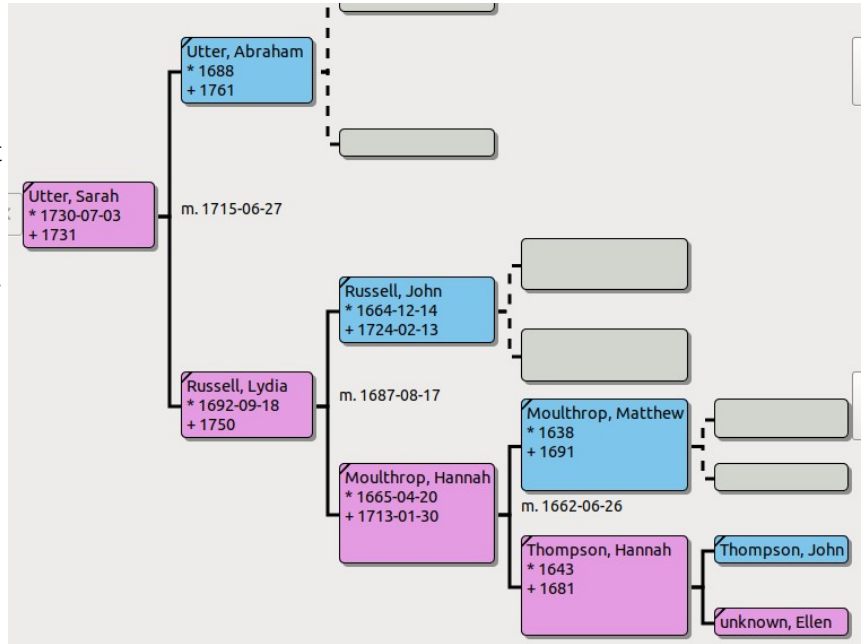

### Abigail Hodges (b. 1731), daughter of Abigail Russell (b. 1701) and Abraham Hodges (b. 1697)

I have found nothing other than a birth record, so she warrants more research.

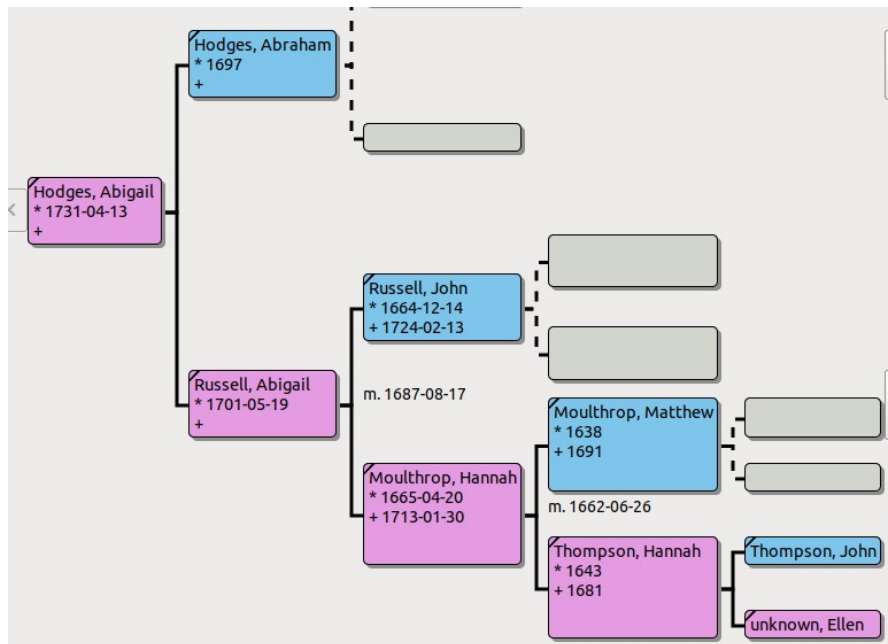

## Tracing Ellen's mtDNA

### **First Daughter of Sarah Shepard Chidsey (b.1728), Hannah Chidsey (b. 1747)**

I have been unable to trace much information for this individual. There is a reference to Dodd's East Haven (register?) to indicate a death in 1840! More work is needed here to get a clear picture, if possible.

### **Sarah Chidsey (b. 1758), daughter of Sarah Shepard (b. 1728) and John Chidsey (b. 1720)**

Sarah appears to have been married to Richard Barrett in East haven, CT, on 1/13/1780. However, it is not clear whether they had children. In fact it is not at all clear that this is a correct association. More investigation is required.

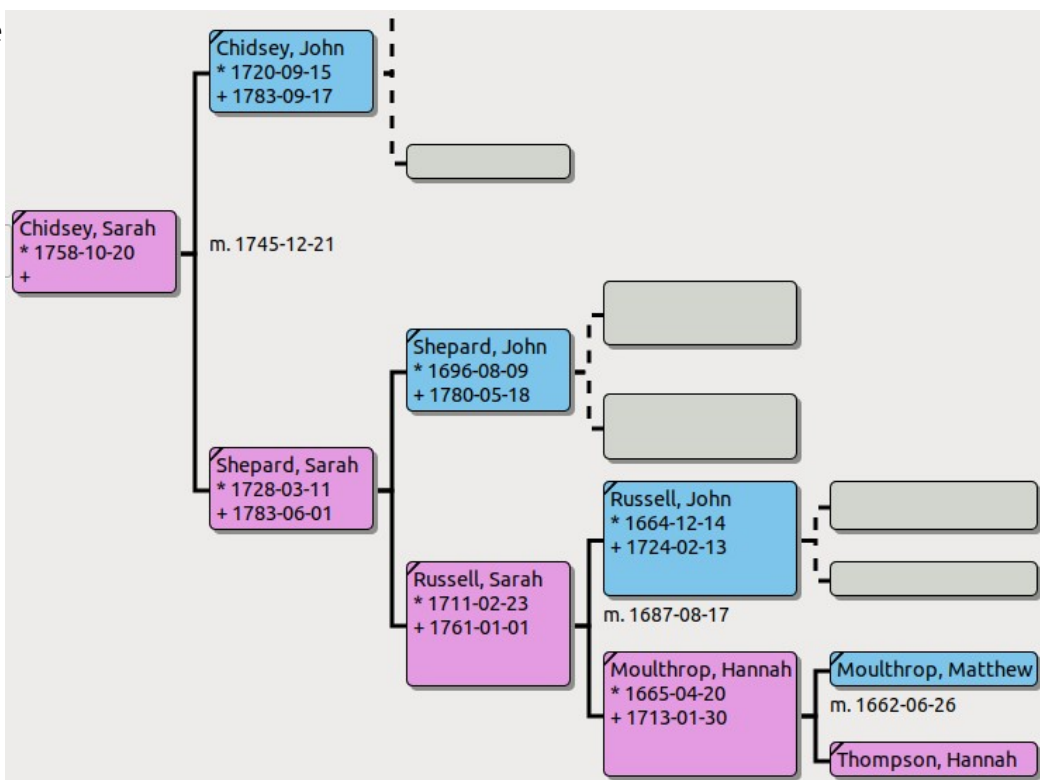

### **Rhoda Chidsey (b. 1764), daughter of Sarah Shepard (b. 1728) and John Chidsey (b. 1720)**

Rhoda may have married William Seymour and ended up in Delaware Co., NY. If so, she had daughters. However, all that is available online that I can find appears to be hearsay. More work is needed here.



## Tracing Ellen's mtDNA

### Mary Shepard's Identity(ies)

I am afraid that there is confusion in the ranks over two families - one headed by Mary Shepard and David Grannis, offspring of Russell and Lydia (Forbes) Grannis and Thomas and Sarah (Hotchkiss) Shepard. The children of this marriage are often listed with the same names as the one from the other marriage - that being between Sarah Russell (daughter of John and Sarah (Russell) Shepard) and the same David Grannis.

The issue of the two Mary's needs to be resolved before anything can be confidently concluded about marriages and offspring.

References:

The Church of Jesus Christ of Latter-day Saints, "International Genealogical Index (IGI)," database, FamilySearch (<https://familysearch.org/ark:/61903/2:1:M6YR-8N1> : accessed 9 February 2019), entry for Mary Shepard, batch A22760-7; citing FHL microfilm 455,111; submitter not specified.

"Pedigree Resource File," database, FamilySearch (<https://familysearch.org/ark:/61903/2:2:SB1J-9LL> : accessed 9 February 2019), entry for Mary /Shepard/, cites sources; file (2:2:2:MMW8-HB9), submitted 15 May 2011.

### Esther Palmer (b. 1751), daughter of Lydia Barker Palmer (b. 1712)

I have been unable to locate any information other than a birth record for this individual, who was born in Branford, CT.

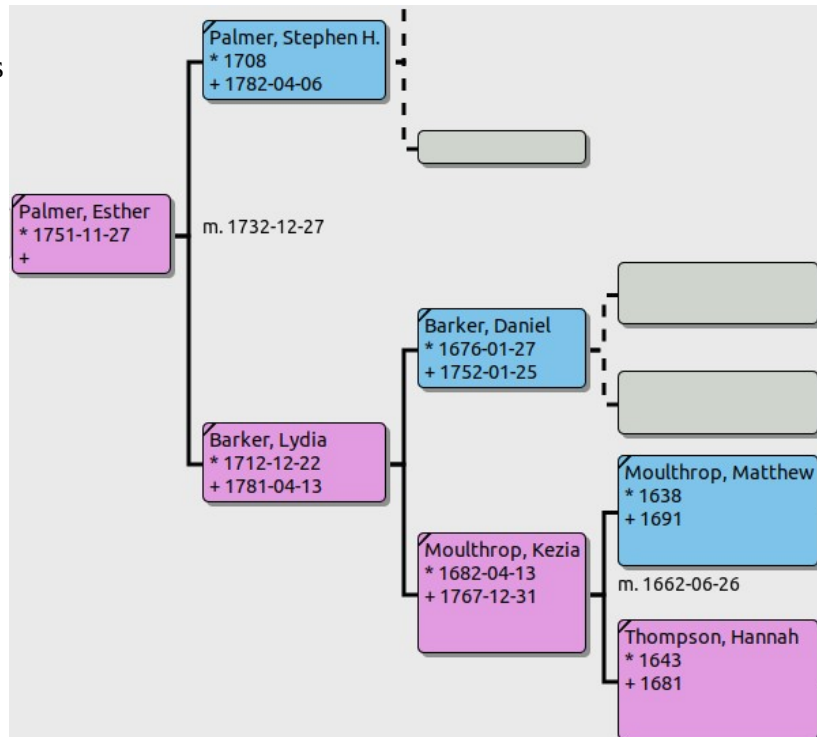

## Tracing Ellen's mtDNA

### **Along Rebecca Thompson's Line**

#### **Elizabeth / Betsy Booth b. 1753**

Daughter Esther had just a daughter, Elizabeth – born in Fairfield Co., CT. However there is confusion in the compiled records about another daughter named Betsy, who might actually be Elizabeth. If they are the same person, she likely married Hezekiah Sanford (?-1834?) and eventually died in Hartford Co., CT.

#### **Sarah Gilbert (1758-?)**

It seems clear that Sarah was a daughter of Eunice Todd and John Gilbert. However, I can find no clear evidence of her marriage or death. She would be easily confused with Sarah Gilbert (b. 9/9/1758) to Hezekiah Gilbert and his with Tameson Gregory in Fairfield Co., CT. More research could be done on this.

Her birth family in fact is somewhat uncertain because of research confusion. There is some confusion that may stem from the existence of two John Gilberts and/or two wives (Eunice Todd versus Lydia Ives). I was not able to sort out the conflicting views of history.

#### **Mary Peck b. 1758 d. ?**

I can find no clear records for Mary other than the record of her birth in New Haven Co., CT. More research is needed.

#### **Pamela Peck b. 1761 d. ?**

I can find no clear records for Pamela. Just one pedigree submission mentions her. - "Pedigree Resource File," database, *FamilySearch* (<https://familysearch.org/ark:/61903/2:2:SBQK-7FM> : accessed 15 February 2019), entry for Pamela /Peck/; file (2:2:2:MM7Y-Z63), submitted 14 May 2011 by shalom [identity withheld for privacy].

#### **Mary Dinah Peck b. 1767**

I can find no clear records for this Mary other than the record of her birth, which shows her name as Mary Dinah. More research is needed.

## Tracing Ellen's mtDNA

### **Along Mary Thompson's Line**

#### **Elizabeth Stone b. 1735 d. ?**

I can find no record of what might have happened to Elizabeth. This is a line that could be investigated further.

#### **Mary (1757? -?), the Daughter of Ruth Alling Hine b. 1738 d. 1777**

Daughter Ruth married Daniel Hine (1734-1798). Their daughters were Mary (1757-?), Kezia (1759-?), Rebecca (1760-?), Eunice (1760-?), Elizabeth (1765-?), and Hannah (1767-?). The history of this family seems a little confusing and poorly defined. The daughters warrant more research.

I have not found more data about Mary Hine (b. 1757). She deserves more research.

It appears that Kezia Hine married Timothy Goodrich (1756-1829). They ended up in VT.

Rebecca Hine (b. 1760) may have married a Hubbard person and moved to VT. She seems to be buried next to her sister, Elizabeth, in Rutland Co., VT. See memorial: <https://www.findagrave.com/memorial/46521466/elizabeth-hine> .

Eunice Hine (b. 1760) seems to have married Jonathan Orms. They lived in Rutland Co., VT, and had a large family.

Elizabeth Hine likely was not married and died in VT. See info about her sister Rebecca above.

#### **Eunice Johnson (Sperry?) b. 1703 d. 1725**

Eunice died quite early in life (age 22). Only one source indicates that she may have married Asa Sperry, but I can find no confirmation of this. For now, I assume that Eunice died "without issue." However, this could be investigated. There may be another mtDNA line here.

#### **Rebecca Painter (Sherman?) b. 1744 d. 1788**

I have seen in ancestry.com that there is suspicion that Rebecca married John Sherman (1734-1803). The evidence does appear to be strong, but if it is correct, they had just one child – Nathan Sherman (1767-1857). See [https://www.ancestry.com/family-tree/person/tree/151746240/person/342011163400/facts?\\_phsrc=VqT14&\\_phstart=successSource](https://www.ancestry.com/family-tree/person/tree/151746240/person/342011163400/facts?_phsrc=VqT14&_phstart=successSource) . This is the only hint that I have had about Rebecca's life. Given the lack of certainty, more research may be worthwhile.

## Tracing Ellen's mtDNA

### **Amy Smith b. 1709 d. ?**

It is clear that Amy was born 3/10/1709 in New Haven to Samuel Smith and Mary Cooper Smith. There is speculation that she died in 1709, or before 1715, or . . . . Her actual fate is unknown based on the evidence that I have seen. More work might be useful here.

### **Mary Smith (Thompson?) b. 1737 d. 1773**

There is speculation that Mary married Joel David Thompson (1737-1804). If that is the case, then there are a number of daughters to consider. This is VERY tentative, however. -

Mary (1763-?)

Sabra (1765-?)

Rachel (1767-?)

Asenath (1769-?)

Phebe (1773-?)

This could be researched to resolve the uncertainty.

## Tracing Ellen's mtDNA

### **Descendants of Ellen Thompson and John Thompson – until 1800 +/-**

1. unknown, Ellen (b. 1621 - England, d. - New Haven, Connecticut)  
sp. Thompson, John (b. 1617 - England, d. 1656)
2. Thompson, John Jr. (b. 1641, d. 1693-02-13)  
sp. Powell, Priscilla (b. 1643, d. 1726)
  3. Thompson, John (b. 1667, d. 1721)
  3. Thompson, Priscilla (b. 1673, d. 1728)
  3. Thompson, Samuel (b. 1677, d. 1712)
  3. Thompson, Abigail (b. 1680)
  3. Thompson, Joseph (b. 1710, d. 1728)
2. Thompson, Mary (b. 1642-04-24 - New Haven, Connecticut, d. 1714-11-17 - New Haven, Connecticut)  
sp. Cooper, John Junior (b. 1642-05-28 - New Haven, Connecticut, d. 1703 - New Haven, Connecticut)
  3. Cooper, Rebecca (b. 1666, d. 1668)
  3. Cooper, unknown (b. 1668, d. 1668)
  3. Cooper, Mary (b. 1669-11-15 - New Haven, Connecticut, d. 1670-04-22 - New Haven, Connecticut)
  3. Cooper, John (b. 1670-02-23 - New Haven, Connecticut)  
sp. Thomas, Sarah (b. 1672)
    4. Cooper, Elizabeth (b. 1694, d. 1776)
  3. Cooper, Sarah (b. 1673-04-26, d. 1736)  
sp. Munson, John (b. 1672-01-28 - New Haven, Connecticut, d. 1749)
    4. Munson, John (b. 1693-07-07)
    4. Munson, Hannah (b. 1697-02-09, d. 1785)  
sp. Andrews, Gideon (d. 1746)
      5. Andrews, Samuel (b. 1742)
    4. Munson, Joel (b. 1702-08-18, d. 1776)
    4. Munson, Amy (b. 1704-09-18)  
sp. Sperry, Joshua (b. 1700, d. 1777)
      5. Sperry, Caleb (b. 1728, d. 1799)
      5. Sperry, Rebecca (b. 1730-06-10 - New Haven, Connecticut)  
sp. Osborne, Jehiel (b. 1728)
        6. Osborne, Amy (b. 1751, d. 1761)
        6. Osborne, Medad (b. 1753, d. 1814)
        6. Osborne, Rachel (b. 1755-10-14)  
sp. Kenney, Michael
        6. Osborne, Lucy (b. 1758, d. 1849)  
sp. Atwater, Zophar (b. 1756, d. 1810)
        6. Osborne, Elisha (b. 1761, d. 1808)
        6. Osborne, Rebecca (b. 1764, d. 1842)  
sp. Hotchkiss, Elijah (b. 1762, d. 1849)
        6. Osborne, Elizabeth (b. 1772)  
sp. Payne, Harmon (b. 1773, d. 1816)
      5. Sperry, Amy (b. 1732-06-10 - New Haven, Connecticut, d. 1748-10-16)
      5. Sperry, Joshua (b. 1734, d. 1759)
      5. Sperry, Phebe (b. 1735-02-18)  
sp. Downs, Joseph (b. 1732)
        6. Downs, Candace (b. 1756)



## Tracing Ellen's mtDNA

6. Peck, John (b. 1756, d. 1825)
6. Peck, Dorcas (b. 1758)  
sp. Osborne, William (b. 1755)
6. Peck, Asenath (b. 1760, d. 1838)  
sp. Russell, Stephen (b. 1756, d. 1817)
6. Peck, Electa (b. 1761)  
sp. Alling, John (b. 1756, d. 1831)
6. Peck, Henry (b. 1764)
6. Peck, Rhoda (b. 1768, d. 1770)
5. Perkins, Eleanor (b. 1726-09-03, d. 1816-05-09)  
sp. Hotchkiss, Solomon (b. 1724)
  6. Hotchkiss, Elizabeth (b. 1749)  
sp. Johnson, Daniel (b. 1749)
  6. Hotchkiss, Solomon (b. 1752, d. 1793)
  6. Hotchkiss, David (b. 1754, d. 1823)
3. Cooper, Samuel (b. 1675-06-20, d. 1762-01-26)  
sp. Smith, Elizabeth
  4. Cooper, Mabel
  4. Cooper, Samuel
  4. Cooper, Isaac
  4. Cooper, Desire
  4. Cooper, Obedience
  4. Cooper, Joel
  4. Cooper, Sarah
  4. Cooper, Abraham Sr.
3. Cooper, Mary (b. 1677-09-04, d. 1761-06-01)  
sp. Smith, Samuel (b. 1678-05-14 - New Haven, Connecticut, d. 1753-08-22 - New Haven, Connecticut)
  4. Smith, Lamberton (b. 1701, d. 1779)
  4. Smith, Obedience (b. 1705-05-19 - New Haven, Connecticut, d. 1705)
  4. Smith, Mary (b. 1707-03-07, d. 1786-05-29)  
sp. Painter, Deliverance (b. 1701-05-31, d. 1781-09-01)
    5. Painter, Samuel (b. 1726, d. 1748)
    5. Painter, Mary (b. 1727-01-14 - New Haven, Connecticut, d. 1804-01-13 - Litchfield, Connecticut)
  - sp. Mallory, Daniel (b. 1719-01-02, d. 1790)
    6. Mallory, Abigail (b. 1748-01-18 - Litchfield, Connecticut)  
sp. Curtis, Israel (b. 1742-04-24 - Litchfield, Connecticut, d. 1802-08-28 - Saratoga, New York)
      7. Curtis, Truman (b. 1770, d. 1803)
      7. Curtis, Polly (b. 1771)
      7. Curtis, Charlotte (b. 1773-10-30 - Woodbury, Litchfield, Connecticut, d. 1848-12-17 - Tompkins County, NY, New York)  
sp. Ball, Lebbeus Jr.
        8. Ball, Stephen C. (b. 1797, d. 1871)
        8. Ball, Alvin Munn (b. 1798, d. 1872)
        8. Ball, Charlotte (b. 1802)
        8. Ball, Calvin Stowe Sr. (b. 1798, d. 1832)
        8. Ball, Betsy (b. 1800, d. 1891)
      7. Curtis, Mary (b. 1776-02-24 - Litchfield, Connecticut, d. 1849-04-30)
      7. Curtis, Martin Luther (b. 1778, d. 1869)
      7. Curtis, Alatheia (b. 1785)
  6. Mallory, Mary (b. 1749-10-17 - Litchfield, Connecticut)

## Tracing Ellen's mtDNA

- sp. Curtis, Stephen (b. 1744-01-08 - Woodbury, Litchfield, Connecticut, d. 1813-02-15 - Southbury, New Haven, Connecticut)
  - 7. Curtis, Abner (b. 1772 - Woodbury, Litchfield, Connecticut, d. 1843 - Pennsylvania)
  - 7. Curtis, Amey (b. 1774-02-08 - Woodbury, Litchfield, Connecticut, d. 1849-04-30 - Southbury, New Haven, Connecticut)
- sp. Tomlinson, William C. (b. 1773-10-27 - New Haven, Connecticut, d. 1819-11-13 - New Haven, Connecticut)
  - 8. Tomlinson, Sarah (b. 1796-10-02 - Southbury, New Haven, Connecticut, d. 1887-01-22 - Southbury, New Haven, Connecticut)
  - sp. Bostwick, Cyrus (b. 1799-03-18 - Southbury, New Haven, Connecticut, d. 1876-03-20 - Southbury, New Haven, Connecticut)
  - 8. Tomlinson, Curtis (b. 1798-02-03)
  - 8. Tomlinson, Clark (b. 1799-05-30)
  - 8. Tomlinson, Harry (b. 1801-03-17)
  - 8. Tomlinson, Stephen (b. 1803-07-29)
  - 8. Tomlinson, Burton (b. 1805-01-01)
  - 8. Tomlinson, Russell (b. 1807-04-05)
  - 8. Tomlinson, Charles (b. 1809-07-06)
  - 8. Tomlinson, Bennet (b. 1811-05-01)
  - 8. Tomlinson, William (b. 1813-02-01)
- 7. Curtis, Sheldon (b. 1776)
- 7. Curtis, Mabel (b. 1778)
- 7. Curtis, Abigail (b. 1780, d. 1855)
- 7. Curtis, Betsy (b. 1783, d. 1870)
- 7. Curtis, Stephen (b. 1785-07-13, d. 1838-12-13)
- 7. Curtis, Charles Ransom (b. 1788-05-07 - Southbury, New Haven, Connecticut, d. 1844-06-02 - Southbury, New Haven, Connecticut)
- 7. Curtis, Laura (b. 1790-08-07 - New Haven, Connecticut)
- 7. Curtis, Louisa (b. 1792, d. 1874-04-24)
- 6. Mallory, Freeloove Amy (b. 1752-04-21 - Woodbury, Litchfield, Connecticut, d. 1794 - Oxford, Litchfield, Connecticut)
- sp. Osborne, Jared (b. 1745-09-24, d. 1832-11-24)
  - 7. Osborne, Gilbert (b. 1782)
  - 7. Osborne, Leverett (b. 1788)
  - 7. Osborne, Ransom (b. 1790)
  - 7. Osborne, Electa (b. 1793)
- 6. Mallory, Edmond (b. 1754)
- 6. Mallory, Lois (b. 1756-03-21)
- sp. Chatfield, Eli (b. 1754, d. 1840)
  - 7. Chatfield, Mary (b. 1778)
  - 7. Chatfield, Obedience (b. 1782, d. 1836)
  - 7. Chatfield, Lucinda (b. 1784)
  - 7. Chatfield, Lewis (b. 1787, d. 1858)
  - 7. Chatfield, Polly (b. 1788)
  - 7. Chatfield, Sherman (b. 1790, d. 1856)
- 6. Mallory, Azariah (b. 1758, d. 1759)
- 6. Mallory, Daniel (b. 1760-04-27)
- 6. Mallory, Adah (b. 1762-05-08 - Litchfield, Connecticut, d. 1808-08-22)
- sp. Hitchcock, Caleb (b. 1760-05-17, d. 1826)
  - 7. Hitchcock, Polly (b. 1795)
  - 7. Hitchcock, Harmon (b. 1785, d. 1817)



## Tracing Ellen's mtDNA

7. Hitchcock, Caleb (b. 1793)
7. Hitchcock, Huldah (b. 1800-03-26, d. 1875-02-20)
7. Hitchcock, Leusania (b. 1802)
7. Hitchcock, Alvah (b. 1807)
7. Hitchcock, Solomon (b. 1786)
7. Hitchcock, Esther (b. 1789-09-04, d. 1860-05-21)
7. Hitchcock, Adah (b. 1788-05-06, d. 1862-10-25)
7. Hitchcock, Phila (b. 1791-04-17, d. 1869-10-26)
7. Hitchcock, Cyrus (b. 1798, d. 1826)
6. Mallory, Rebecca (b. 1764-02-05 - Litchfield, Connecticut)
6. Mallory, Mabel (b. 1765-11-17 - Litchfield, Connecticut)
6. Mallory, Pene (b. 1767-09-09 - Litchfield, Connecticut)
5. Painter, Amy (b. 1730, d. 1751-09-02)
5. Painter, Thomas (b. 1733, d. 1755)
5. Painter, Abigail (b. 1736, d. 1755-01-26)
5. Painter, Lamberton (b. 1740, d. 1795)
5. Painter, Rebecca (b. 1744, d. 1788-09-18)
5. Painter, Freelove (b. 1749, d. 1751-08-26)
4. Smith, Amy (b. 1709-03-10, d. 1709)
4. Smith, Margaret (b. 1711-06-26, d. 1803-03-27 - Connecticut)  
sp. Smith, Austin (b. 1711-04-04 - New Haven, Connecticut, d. 1797-02-08 - Waterbury, Connecticut)
  5. Smith, Margaret (b. 1734-11-05 - New Haven, Connecticut, d. 1821-10-22)  
sp. Thompson, Jonathan (b. 1733, d. 1784)
    6. Thompson, Stephen (b. 1759)
    6. Thompson, Esther (b. 1766)
    6. Thompson, Mary (d. 1829)  
sp. Hopkins, David (b. 1762, d. 1814)
      7. Hopkins, John
      7. Hopkins, Polly
      7. Hopkins, David
      7. Hopkins, Mabel
      7. Hopkins, Laura
      7. Hopkins, Truman
      7. Hopkins, Edwin
  5. Smith, Mary (b. 1737-02-20 - New Haven, Connecticut, d. 1773-12-07)
  5. Smith, Gad (b. 1740-07-29, d. 1786)
  5. Smith, Austin (b. 1742)
  5. Smith, Hannah (b. 1746)  
sp. Hickox, James (b. 1746-11-28 - Waterbury, Connecticut, d. 1833-11-08)
    6. Hickox, Olive (b. 1774-05-07 - Waterbury, Connecticut, d. 1806-12-06 - Naugatuck, New Haven, Connecticut)  
sp. Bouton, John (b. 1766 - Fairfield, Connecticut, d. 1840 - Naugatuck, New Haven, Connecticut)
      7. Bouton, Hannah
      7. Bouton, Polly
      7. Bouton, Sally
      7. Bouton, Asa Smith
      7. Bouton, Olive
      7. Bouton, Laura
      7. Bouton, Lowman
      7. Bouton, James

## Tracing Ellen's mtDNA

5. Smith, Philena (b. 1750 - Fairfield, Connecticut Colony, d. 1826-11-17 - Chenango County, NY, New York State)  
sp. Hickox, Gideon (b. 1752-05-04 - Waterbury, Connecticut, d. 1824-04-25 - Pitcher, New York)
  6. Hickox, David (b. 1772-12-08, bur. 1847-11-08 - Naugatuck, New Haven, Connecticut)  
sp. Dutton, Kezia (b. 1783, d. 1865)
    7. Hickox, Caleb Thompson (b. 1817, d. 1895)
  6. Hickox, Sarah (b. 1774-04-15 - Waterbury, Connecticut, d. 1864-07-05 - Taylor, New York)  
sp. Beebe, Orillana (b. 1770-03-20, d. 1863-02-25 - Taylor, Cortland, New York)
    7. Beebe, Cokeley/Coakley (b. 1791)
    7. Beebe, Philena (b. 1793-05-06 - Waterbury, Connecticut)
    7. Beebe, Abraham
    7. Beebe, Keziah
    7. Beebe, Mary (b. 1803)
    7. Beebe, Gideon
    7. Beebe, Hannah
    7. Beebe, Orin
    7. Beebe, Lucinda
    7. Beebe, Alonzo
  6. Hickox, Polly (b. 1777-03-04 - Waterbury, Connecticut, d. 1849-09-24 - Pitcher, New York)  
sp. Warner, Richard (b. 1772-06-21 - Waterbury, Connecticut, d. 1857-03-25 - Pitcher, New York)
    7. Warner, Obadiah (b. 1793-04-13 - New Haven, Connecticut, d. 1868-11-23 - Naugatuck, New Haven, Connecticut)  
sp. Sperry, Lucy L. (b. 1797 - Connecticut, d. 1863-05-04 - New Haven, Connecticut)
      8. Warner, Eliza (b. 1819)
      8. Warner, Clarissa (b. 1821, d. 1849-12-06)
    7. Warner, Sheldon (b. 1794-11-20 - New Haven, Connecticut, d. 1892-02-04 - New York)  
sp. , Lucy
    7. Warner, Adna (b. 1796-04-09 - Connecticut, d. 1881 - Connecticut)  
sp. Carter, Lucia (b. 1796 - Connecticut, d. 1880 - Connecticut)
      8. Warner, Lucien
      8. Warner, Julia Halbert
      8. Warner, Fredric Addison (b. 1836, d. 1905)  
sp. Dodge, Mary M. (b. 1843 - New Hampshire, d. 1903)
    7. Warner, Minerva (b. 1798-01-22)  
sp. Fenton, Elijah
    7. Warner, Edward G. (b. 1799-05-14 - New Haven, Connecticut, d. 1890-10-20 - Ohio)  
sp. Sales, Sophronia (b. 1806-08-26 - Ohio, d. 1840-03-12)
      8. Warner, Mary Othelia
      8. Warner, Edward C.
      8. Warner, Bellva
      8. Warner, Maria
      8. Warner, Adeline
      8. Warner, Lemira
      8. Warner, Artemissa

## Tracing Ellen's mtDNA

- 8. Warner, Calvin E.
- 8. Warner, Joseph V.
- 8. Warner, Sophronia C.
- 7. Warner, Maria (b. 1800-12-03, d. 1895)  
sp. Hinman, John
- 7. Warner, David H. (b. 1802-02-02, d. 1896-08-09 - Ohio)  
sp. Robbins, Almira (b. 1803-07-26 - New York, d. 1853-07-10 - Ohio)
  - 8. Warner, Elizabeth B.
  - 8. Warner, Adeline
  - 8. Warner, Mary
  - 8. Warner, David S.
  - 8. Warner, Richard
  - 8. Warner, Eliza
- sp. Clayton, Mary (b. 1819)
  - 8. Warner, Florilla
  - 8. Warner, John H.
  - 8. Warner, Lucy
- 7. Warner, Curtis (b. 1802-07-04, d. 1841)  
sp. Hyde, Caroline  
sp. Robbins, Elizabeth (b. 1813)
  - 8. Warner, Charles Edward (b. 1835-05-31)
  - 8. Warner, John (b. 1837)
  - 8. Warner, Curtis (b. 1841)
  - 8. Warner, Mary (b. 1843)
- 7. Warner, Rachel (b. 1805-07-04, d. 1882)  
sp. Pierce, Orlando
- 7. Warner, Electa (b. 1807-07-05 - Parma, Chemung, New York, Chemung, New York, d. 1863-08-14 - Blooming Valley, Crawford, Pennsylvania)  
sp. Robbins, John Edwin Junior (b. 1801-06-01 - Connecticut, d. 1877-03-13 - Blooming Valley, Crawford, Pennsylvania)
  - 8. Robbins, Louisa Esther (b. 1829-12-02 - Oakland, Livingston, New York, d. 1922-12-06 - Blooming Valley, Crawford, Pennsylvania)  
sp. Hatch, Columbus (b. 1826 - Crawford, Pennsylvania, d. 1904 - Campbell, South Dakota)
  - 8. Robbins, John Edwin III (b. 1831-03-06 - Oakland, Livingston, New York, d. 1901-04-09 - Albion PA, Erie, Pennsylvania)
  - 8. Robbins, Sophia Electa (b. 1832-07-29 - Oakland, Livingston, New York, d. 1871-01-01 - Blooming Valley, Crawford, Pennsylvania)
  - 8. Robbins, Lucia Elila (b. 1834-10-17 - Oakland, Livingston, New York, d. 1910-10-20 - Canby, Clackamas, Oregon)  
sp. Allen, James Henry (b. 1831-11-29 - Brant, NY, Erie County, NY, New York, d. 1888-11-29 - Mound City, Campbell, South Dakota, US)
  - 8. Robbins, Calvin (b. 1837, d. 1839)
  - 8. Robbins, Mary Elizabeth (b. 1840-01-06 - Crawford, Pennsylvania, d. 1877-05-11 - Crawford, Pennsylvania)
  - 8. Robbins, Mariah (b. 1844-01-02 - Crawford, Pennsylvania, d. 1926-10-14 - Summit County, OH, Ohio)
  - 8. Robbins, Martha Naomi (b. 1845-07-19 - New York, d. 1936-05-13)
  - 8. Robbins, Helen Josephine (b. 1847-04-14 - Richmond, Pennsylvania, USA, d. 1883-04-15 - Townville, PA, USA)  
sp. Frost, Richard Chambers (b. 1849-05-28 - Erie, Pennsylvania, USA, d. 1913-02-17 - Cleveland, Ohio, USA)

## Tracing Ellen's mtDNA

7. Warner, Lucina (b. 1809-07-05)  
sp. Burnham, Norman
7. Warner, Calvin J. (b. 1812-08-00)  
sp. Knight, Delia
  8. Warner, Robert (b. 1837)
  8. Warner, Agnes (b. 1844, d. 1897)
  8. Warner, Francis E. (b. 1847)
  8. Warner, Edwin (b. 1851)
  8. Warner, Delia K. (b. 1854)
  8. Warner, Carrie (b. 1859)
  8. Warner, Calvin (b. 1859, d. 1933)
  8. Warner, Bertha (b. 1860)
7. Warner, Florilla (b. 1815-07-06)
7. Warner, Elmina (b. 1817-09-21)  
sp. Swan, George P.
7. Warner, Richard P. (b. 1819-04-16 - Pitcher, New York, d. 1920-03-16 - New York)  
sp. Debell, Helen (b. 1832, d. 1927)
  8. Warner, Richard Emmons (b. 1862, d. 1936)
  8. Warner, Shelden P. (b. 1865, d. 1951)
6. Hickox, Hannah Smith (b. 1781-07-02 - New Haven, Connecticut, d. 1856-11-06)  
sp. Terrill, Elias (b. 1766-09-20, d. 1835-08-21)
  7. Terrill, Irene
  7. Terrill, Julia Marcia
  7. Terrill, Beulah Smith
  7. Terrill, Susan Hadley
  7. Terrill, Leonora
  7. Terrill, Elias
  7. Terrill, Shelby Wayne
  7. Terrill, Josiah Rice
  7. Terrill, Stephen Dodd
  7. Terrill, Nancy Judson
  7. Terrill, Samuel Newell
  7. Terrill, Eunice Celestia
5. Smith, Anthony (b. 1752, d. 1838-03-03)
5. Smith, Mehitabel (b. 1755-05-28, d. 1834-10-28)  
sp. Benham, Elihu (b. 1749-04-26 - New Haven, Connecticut, d. 1836-02-28 - Waterbury, Connecticut)
  6. Benham, Mehitabel (b. 1773)
  6. Benham, Sally (b. 1775)
  6. Benham, Elihu (b. 1777)
  6. Benham, Laurena (b. 1785)
  6. Benham, Ransom (b. 1790, d. 1860)
  6. Benham, Philena (b. 1791)
  6. Benham, Barzll (b. 1795, d. 1878)
  6. Benham, Lewis (b. 1796)
  6. Benham, Desire (b. 1798, d. 1803)
  6. Benham, Leverett (b. 1799, d. 1851)
4. Smith, Thankful (b. 1712-09-30, d. 1769-06-28)  
sp. Tolles, Daniel (b. 1705, d. 1782-06-20)
  5. Tolles, Thankful (b. 1737, d. 1820)  
sp. Sanford, Daniel (b. 1730, d. 1777)

## Tracing Ellen's mtDNA

6. Sanford, Irenah (b. 1753-11-07, d. 1830-09-09 - Litchfield, Connecticut)  
sp. Fenn, Samuel (b. 1743 - New Haven, Connecticut, d. 1820 - Litchfield, Connecticut)
  7. Fenn, Irena (b. 1768)
  7. Fenn, Samuel (b. 1770)
  7. Fenn, Eli (b. 1772, d. 1822)
  7. Fenn, Chloe (b. 1774)
  7. Fenn, Thankful (b. 1776, d. 1828)
  7. Fenn, Anna (b. 1778)
6. Sanford, Thankful (b. 1755-11-06, d. 1759)
6. Sanford, Ezekial (b. 1757-11-25, d. 1794-04-04)
6. Sanford, lois (b. 1760-06-15, d. 1832-04-30)  
sp. Curtis, Daniel (b. 1754-02-12 - New Haven, Connecticut, d. 1803-03-03 - Litchfield, Connecticut)
  7. Curtis, Polly (b. 1782-09-13 - Litchfield, Connecticut)
  7. Curtis, Eli (b. 1786-09-05)
  7. Curtis, Philena (b. 1779-10-02 - Litchfield, Connecticut)
6. Sanford, Phebe (b. 1762-09-20, d. 1829-01-24 - New York)  
sp. Martin, Samuel (b. 1759 - Waterbury, Connecticut)
  7. Martin, Fanny
  7. Martin, Phebe
  7. Martin, Harry
  7. Martin, James
  7. Martin, Daniel
  7. Martin, Samuel
  7. Martin, Peter
  7. Martin, Charlotte
6. Sanford, Eli (b. 1767-02-28 - Waterbury, Connecticut, d. 1827-04-07 - Ohio)
5. Tolles, Nehemiah (b. 1739, d. 1774)
5. Tolles, Daniel (b. 1741)
5. Tolles, Lazarus (b. 1743)
5. Tolles, Dorothy (b. 1745)
5. Tolles, Desire (b. 1745-10-12, d. 1812-06-12)  
sp. Beecher, Abraham (b. 1745, d. 1823)
  6. Beecher, Abraham (b. 1771)
  6. Beecher, Philemon
  6. Beecher, Jesse
  6. Beecher, Amos
  6. Beecher, Isaac
  6. Beecher, Eli
  6. Beecher, Frances
  6. Beecher, Lyman
  6. Beecher, Elizabeth
  6. Beecher, Betsy
  6. Beecher, Robert
5. Tolles, Titus (b. 1746)
5. Tolles, Daniel (b. 1748, d. 1829)
5. Tolles, Lamberton (b. 1750, d. 1821)
5. Tolles, Jared (b. 1752, d. 1841)
5. Tolles, Abraham (b. 1754, d. 1793)
5. Tolles, Mary (b. 1756, d. 1842-09-10)  
sp. Thomas, Noah (b. 1756, d. 1818-09-06)

## Tracing Ellen's mtDNA

- 6. Thomas, Daniel
- 6. Thomas, Aner
- 6. Thomas, Laura
- 6. Thomas, Leveret
- 6. Thomas, Ransom
- 6. Thomas, Charles
- 3. Cooper, Abigail (b. 1679-10-03, d. 1724-12-06)
  - sp. Johnson, Isaac (b. 1672, d. 1750)
    - 4. Johnson, Eunis (b. 1703-05-01, d. 1725-09-05)
    - 4. Johnson, David (b. 1721, d. 1758)
- 3. Cooper, Hannah (b. 1681-08-10, d. 1772-11-11)
  - sp. Lines, John (b. 1676, d. 1709)
    - 4. Lines, Kezia (b. 1715-04-05, d. 1782-01-12)
      - sp. Alling, Samuel (b. 1715, d. 1788)
        - 5. Alling, Ruth (b. 1738-10-08, d. 1777-06-18)
          - sp. Hine, Dan (b. 1734)
            - 6. Hine, Mary (b. 1757)
            - 6. Hine, Kezia (b. 1759)
            - 6. Hine, Rebecca (b. 1760)
            - 6. Hine, Eunice (b. 1760)
            - 6. Hine, Dan (b. 1763)
            - 6. Hine, Elizabeth (b. 1765)
            - 6. Hine, Hannah (b. 1767)
            - 6. Hine, Alexander (b. 1769)
          - 5. Alling, Roger (b. 1741, d. 1824)
          - 5. Alling, Samuel (b. 1743, d. 1810)
          - 5. Alling, Amos (b. 1745, d. 1813)
          - 5. Alling, Kezia (b. 1748-11-26, d. 1765-11-09)
          - 5. Alling, Cornelius (b. 1748, d. 1805)
          - 5. Alling, Eleanor (b. 1751-11-27, d. 1809-10-09)
          - 5. Alling, Hannah (b. 1751-11-27, d. 1821-12-31)
          - 5. Alling, Gideon (b. 1754, d. 1830)
          - 5. Alling, John (b. 1756, d. 1831)
            - sp. Peck, Electa (b. 1761)
  - 3. Cooper, Joseph (b. 1683-09-11 - New Haven, Connecticut, d. 1747)
    - sp. Smith, Abigail
      - 4. Cooper, Phoebe (b. 1707, d. 1750)
      - 4. Cooper, Thankful (b. 1721, d. 1808)
  - 3. Cooper, Rebecca (chr. 1689-08-24, d. 1770-01-02)
    - sp. Alling, Daniel (b. 1688, d. 1756)
      - 4. Alling, Timothy (b. 1712, d. 1772)
      - 4. Alling, Phebe (b. 1723-03-24, d. 1788-04-23)
        - sp. Wolcott, William (b. 1736, d. 1788)
          - 5. Wolcott, Phebe (b. 1755-05-18, d. 1832-07-29)
            - sp. Barney, Hanover (b. 1750, d. 1839)
              - 6. Barney, William (b. 1777, d. 1870)
              - 6. Barney, Silence (b. 1779, d. 1805)
              - 6. Barney, Anna (b. 1781)
              - 6. Barney, Charles (b. 1783)
              - 6. Barney, James (b. 1785)
              - 6. Barney, Susan (b. 1787)
              - 6. Barney, Lebbeus (b. 1790, d. 1795)



## Tracing Ellen's mtDNA

- sp. Brewster, William (b. 1695, d. 1764)
  - 5. Brewster, Samuel (b. 1738)
  - 5. Brewster, Pelatiah (b. 1741, d. 1806)
  - 5. Brewster, John (b. 1746)
- 4. Russell, Mabel (b. 1706-07-14, d. 1782-04-20)
  - sp. Utter, Benjamin (b. 1709-11-24)
    - 5. Utter, Mary (b. 1737)
      - sp. Russell, Benjamin (b. 1735-02-02)
    - 5. Utter, Mabel (b. 1765)
- 4. Russell, Sarah (b. 1711-02-23, d. 1761-01-01 - East haven, New Haven, Connecticut)
  - sp. Shepard, John (b. 1696-08-09 - Bristol, Rhode Island, d. 1780-05-18 - East haven, New Haven, Connecticut)
    - 5. Shepard, Sarah (b. 1728-03-11 - East haven, New Haven, Connecticut, d. 1783-06-01 - East haven, New Haven, Connecticut)
      - sp. Chidsey, John (b. 1720-09-15 - East haven, New Haven, Connecticut, d. 1783-09-17 - East haven, New Haven, Connecticut)
        - 6. Chidsey, Hannah (b. 1747-05-06, d. 1840-09-07)
        - 6. Chidsey, John (b. 1749-12-16, d. 1816-05-06)
        - 6. Chidsey, Ephraim (b. 1752-03-19, d. 1832-09-26)
        - 6. Chidsey, Roswell (b. 1754-07-17, d. 1795-02-01)
        - 6. Chidsey, Street (b. 1756-11-15, d. 1777-04-20)
        - 6. Chidsey, Sarah (b. 1758-10-20 - East haven, New Haven, Connecticut)
        - 6. Chidsey, Simon (b. 1762-03-03)
        - 6. Chidsey, Rhoda (b. 1764-07-21 - East haven, New Haven, Connecticut, d. 1820-03-26 - Canonsville, Delaware, New York)
        - 6. Chidsey, Mary (b. 1765-09-26 - East haven, New Haven, Connecticut)
          - sp. Curtis, Phineas (b. 1765, d. 1806)
            - 7. Curtis, Polly (b. 1788, d. 1836)
            - 7. Curtis, Hannah (b. 1790, d. 1848)
            - 7. Curtis, Russell (b. 1792)
            - 7. Curtis, Lowly (b. 1794)
            - 7. Curtis, Asenath (b. 1796)
            - 7. Curtis, Benjamin (b. 1798)
            - 7. Curtis, Major (b. 1800)
            - 7. Curtis, John (b. 1802, d. 1834)
            - 7. Curtis, Susan (b. 1804)
            - 7. Curtis, Street (b. 1806, d. 1808)
        - 6. Chidsey, Eunice (b. 1768-05-01 - East haven, New Haven, Connecticut)
          - sp. Walker, William (b. 1766-02-06 - East haven, New Haven, Connecticut)
            - 7. Walker, John (b. 1788)
            - 7. Walker, William (b. 1790)
            - 7. Walker, James (b. 1792)
          - 6. Chidsey, Samuel (b. 1770-10-08 - East haven, New Haven, Connecticut, d. 1771-04-10 - East haven, New Haven, Connecticut)
          - 6. Chidsey, Ezekiel (b. 1770-10-08, d. 1850-01-27)
    - 5. Shepard, Mary (b. 1731-09-13, d. 1743-09-28)
    - 5. Shepard, Elizabeth (b. 1734-07-20 - East haven, New Haven, Connecticut, d. 1819-02-21 - Windham, Vermont)
      - sp. Hotchkiss, Enos (b. 1731-05-13, d. 1806-10-27)
        - 6. Hotchkiss, Huldah (d. 1851)
        - 6. Hotchkiss, Elihu (b. 1756, d. 1840)
        - 6. Hotchkiss, Enoch (b. 1763, d. 1836)



## Tracing Ellen's mtDNA

6. Hotchkiss, Stephen (b. 1772, d. 1851)
5. Shepard, John (b. 1736, d. 1743)
5. Shepard, Stephen (b. 1740, d. 1819)
5. Shepard, John (b. 1743, d. 1811)
5. Shepard, Mary (b. 1746-09-30, d. 1838-02-09 - East haven, New Haven, Connecticut)
  - sp. Grannis, David (b. 1744, d. 1785-05-17 - East haven, New Haven, Connecticut)
    6. Grannis, Mary (b. 1764)
      - sp. Eaton, Giles (b. 1756)
        7. Eaton, Mary
    6. Grannis, Huldah (b. 1766)
      - sp. Barnes, Levi (b. 1762)
        7. Barnes, Levi (b. 1792)
        7. Barnes, Nancy (b. 1798)
        7. Barnes, Asenath (b. 1794)
        7. Barnes, Lydia (b. 1796)
    6. Grannis, Lydia (b. 1769, d. 1770)
    6. Grannis, Lydia (b. 1771, d. 1856-12-11)
      - sp. Bradley, Amma (b. 1769-11-21, d. 1832-08-24)
        7. Bradley, James (b. 1795, d. 1796)
        7. Bradley, Nancy (b. 1797)
        7. Bradley, James (b. 1801, d. 1813)
        7. Bradley, Almira (b. 1803)
    6. Grannis, Sarah (b. 1773)
      - sp. Webster, Elihu (b. 1769)
    6. Grannis, Mabel (b. 1775)
    6. Grannis, Asenath (b. 1779, d. 1848-11-18)
      - sp. Bradley, Asahel (b. 1778, d. 1861)
        7. Bradley, Betsy
        7. Bradley, Asenath
        7. Bradley, Eben
        7. Bradley, Joseph
        7. Bradley, Mary
        7. Bradley, Jared
        7. Bradley, Asahel
        7. Bradley, Lydia
        7. Bradley, Jared Eben
        7. Bradley, Lydia
    6. Grannis, Elizabeth (b. 1781)
      - sp. Barrow, Francis (b. 1787, d. 1853)
        7. Barrow, Henry
        7. Barrow, Typhena
        7. Barrow, George F.
        7. Barrow, Eliza A.
        7. Barrow, Edwin S.
        7. Barrow, Mary G.
        7. Barrow, Clarissa M.
      6. Grannis, David (b. 1784, d. 1803 - East haven, New Haven, Connecticut)
    5. Shepard, Levi (b. 1753)
    5. Shepard, Huldah (b. 1755-11-25 - East haven, New Haven, Connecticut)
      - sp. Townsend, Elias (b. 1754-03-25)
        6. Townsend, Huldah (b. 1782)
        6. Townsend, Elias (b. 1779)

## Tracing Ellen's mtDNA

6. Townsend, Elizabeth (b. 1784)
6. Townsend, Nancy (b. 1788)
3. Moulthrop, John (b. 1667-02-05)
3. Moulthrop, Matthew (b. 1670-07-18)
3. Moulthrop, unknown (b. 1673)
3. Moulthrop, Lydia (b. 1674-08-08, d. 1677-10-14)
3. Moulthrop, Samuel (b. 1677-06-24, d. 1677-10-14)
3. Moulthrop, Samuel (b. 1679-04-13)
3. Moulthrop, Kezia (b. 1682-04-13, d. 1767-12-31)
  - sp. Barker, Daniel (b. 1676-01-27, d. 1752-01-25)
    4. Barker, Joseph (b. 1702, d. 1746)
    4. Barker, Daniel (b. 1705, d. 1801)
    4. Barker, Hannah (b. 1707-11-15, d. 1785-07-18)
      - sp. Rose, David (b. 1700-12-06, d. 1785-09-19)
        5. Rose, Keziah (b. 1730-02-25, d. 1754-09-08)
          - sp. Hudson, David
            6. Hudson, David (b. 1754, d. 1755-01-14)
          5. Rose, David (b. 1736, d. 1799)
          5. Rose, Simeon (b. 1747, d. 1776)
          5. Rose, Levi (b. 1751, d. 1831)
        4. Barker, Edward (b. 1708, d. 1763)
        4. Barker, Kezia (b. 1710-04-03, d. 1793-06-05)
          - sp. Smith, Dow (b. 1704)
            5. Smith, Isaac (b. 1743)
            5. Smith, Dow (b. 1745)
            5. Smith, Daniel (b. 1748)
            5. Smith, Jordan (b. 1733)
          4. Barker, Lydia (b. 1712-12-22, d. 1781-04-13)
            - sp. Palmer, Stephen H. (b. 1708, d. 1782-04-06)
              5. Palmer, Stephen (b. 1735)
              5. Palmer, Phebe (b. 1738-03-03, d. 1788)
                - sp. Foote, Ebenezer (b. 1734)
                  6. Foote, Thankful (b. 1759-09-24)
                    - sp. Smith, Isaac (b. 1755)
                  6. Foote, Lucretia (bap. 1775-09-24)
                    - sp. Butler, James (b. 1761)
                5. Palmer, Ebenezer (b. 1743)
                5. Palmer, Asahel (b. 1747)
                5. Palmer, Esther (b. 1751-11-27)
            4. Barker, Samuel (b. 1715, d. 1781)
            4. Barker, Thankful (b. 1719-04-19, d. 1791-10-26)
              - sp. Rose, Nathan (b. 1705, d. 1789)
                5. Rose, Sarah (b. 1748-04-24, d. 1821-01-10)
                  - sp. Whedon, Solomon (b. 1749, d. 1814-12-12)
                    6. Whedon, Lucretia (b. 1782, d. 1807)
                  5. Rose, Joseph (d. 1776)
                  5. Rose, Nathan (d. 1844)
                4. Barker, Timothy (b. 1723, d. 1779)
            2. Thompson, Ebenezer (b. 1648-10-15, d. 1674)
            2. Thompson, Joseph (b. 1649, d. 1703)
              - sp. Lathrop, Elizabeth
            2. Thompson, Abigail (b. 1651-01-26, d. 1727)



## Tracing Ellen's mtDNA

7. Curtis, Polly (b. 1782-09-13 - Litchfield, Connecticut)
7. Curtis, Eli (b. 1786-09-05)
7. Curtis, Philena (b. 1779-10-02 - Litchfield, Connecticut)
6. Sanford, Phebe (b. 1762-09-20, d. 1829-01-24 - New York)  
sp. Martin, Samuel (b. 1759 - Waterbury, Connecticut)
  7. Martin, Fanny
  7. Martin, Phebe
  7. Martin, Harry
  7. Martin, James
  7. Martin, Daniel
  7. Martin, Samuel
  7. Martin, Peter
  7. Martin, Charlotte
6. Sanford, Eli (b. 1767-02-28 - Waterbury, Connecticut, d. 1827-04-07 - Ohio)
5. Tolles, Nehemiah (b. 1739, d. 1774)
5. Tolles, Daniel (b. 1741)
5. Tolles, Lazarus (b. 1743)
5. Tolles, Dorothy (b. 1745)
5. Tolles, Desire (b. 1745-10-12, d. 1812-06-12)  
sp. Beecher, Abraham (b. 1745, d. 1823)
  6. Beecher, Abraham (b. 1771)
  6. Beecher, Philemon
  6. Beecher, Jesse
  6. Beecher, Amos
  6. Beecher, Isaac
  6. Beecher, Eli
  6. Beecher, Frances
  6. Beecher, Lyman
  6. Beecher, Elizabeth
  6. Beecher, Betsy
  6. Beecher, Robert
5. Tolles, Titus (b. 1746)
5. Tolles, Daniel (b. 1748, d. 1829)
5. Tolles, Lamberton (b. 1750, d. 1821)
5. Tolles, Jared (b. 1752, d. 1841)
5. Tolles, Abraham (b. 1754, d. 1793)
5. Tolles, Mary (b. 1756, d. 1842-09-10)  
sp. Thomas, Noah (b. 1756, d. 1818-09-06)
  6. Thomas, Daniel
  6. Thomas, Aner
  6. Thomas, Laura
  6. Thomas, Leveret
  6. Thomas, Ransom
  6. Thomas, Charles
4. Tolles, Henry (b. 1705)
4. Tolles, Dorothy (b. 1711, d. 1785-08-14)  
sp. Bristol, Stephen (b. 1707, d. 1785)
  5. Bristol, Stephen (b. 1734, d. 1789)
  5. Bristol, Ichabod (b. 1736)
  5. Bristol, Abner (b. 1738, d. 1790)
  5. Bristol, Rachel (b. 1739-12-11 - New Haven, Connecticut, d. 1817-05-06 - New Haven, Connecticut)

## Tracing Ellen's mtDNA

5. Bristol, David (b. 1742, d. 1790)
5. Bristol, Dorothy (b. 1748 - New Haven, Connecticut, d. 1834-08-12 - New Haven, Connecticut)
5. Bristol, Dinah (b. 1751 - New Haven, Connecticut, d. 1785-06-17 - New Haven, Connecticut)
4. Tolles, Samuel (b. 1715, d. 1756)
4. Tolles, Ebenezer (b. 1728, d. 1754)
4. Tolles, Mary (b. 1730, d. 1731)
3. Thomas, Daniel (b. 1676-02-14, d. 1760)
3. Thomas, Dinah (b. 1678-12-26, d. 1769)
- sp. Sherman, John (b. 1673, d. 1727)
  4. Sherman, Lydia (b. 1699-12-20, d. 1733-09-17 - New Haven, Connecticut)
  - sp. Todd, James (b. 1696, d. 1779)
    5. Todd, Ebenezer (b. 1722, d. 1798)
    5. Todd, James (b. 1725, d. 1806)
    5. Todd, Lydia (b. 1727-07-06 - New Haven, Connecticut, d. 1819-09-14)
  - sp. Smith, James (b. 1713, d. 1805)
    6. Smith, Mary (b. 1747, d. 1796)
    6. Smith, James (b. 1750, d. 1809)
    6. Smith, Benjamin (b. 1753, d. 1774)
    6. Smith, John (b. 1756, d. 1847)
    6. Smith, Thomas (b. 1761, d. 1815)
    6. Smith, Eli (b. 1764, d. 1845)
    6. Smith, Mabel (b. 1769-01-20, d. 1842)
  - sp. Munson, Merriman (d. 1818)
    7. Munson, Ira (b. 1792, d. 1841)
    7. Munson, Roswell (b. 1798, d. 1860)
    7. Munson, Mary (b. 1804-12-08, d. 1889-07-04)
5. Todd, Lois (b. 1729-11-10 - New Haven, Connecticut, d. 1812-09-27 - New Haven, Connecticut)
  - sp. Turner, James (b. 1727, d. 1788)
    6. Turner, Lois (b. 1748-10-12 - New Haven, Connecticut, d. 1776-10-31 - New Haven, Connecticut)
    6. Turner, Bethuel (b. 1751)
    6. Turner, Mary (b. 1754-04-17 - New Haven, Connecticut, d. 1829-01-05 - New Haven, Connecticut)
    6. Turner, Dorcas (b. 1756-09-30 - New Haven, Connecticut, d. 1831-01-13 - New Haven, Connecticut)
    6. Turner, Bethuel (b. 1761)
5. Todd, Eunice (b. 1732-06-10 - New Haven, Connecticut, d. 1823 - New Haven, Connecticut)
  - sp. Gilbert, John (b. 1731-11-09)
    6. Gilbert, Sarah (b. 1758-08-26 - New Haven, Connecticut)
    6. Gilbert, Eunice (b. 1762-02-20, d. 1835)
      - sp. Tuttle, Jesse (b. 1759, d. 1848)
    6. Gilbert, John (b. 1764, d. 1774)
    6. Gilbert, Mabel (bap. 1767-05-10)
      - sp. Munson, Ezra (b. 1757, d. 1800)
    6. Gilbert, Lydia (bap. 1769-01-29 - New Haven, Connecticut, d. 1774-10-02 - New Haven, Connecticut)
    6. Gilbert, Julius (b. 1771)
4. Sherman, Dinah (b. 1702-10-27, d. 1739-12-19 - New Haven, Connecticut)



## Tracing Ellen's mtDNA

- 5. Morgan, Mary (b. 1751-05-07, d. 1768-01-20 - Clinton, Middlesex, Connecticut)
- 5. Morgan, Theophilus (b. 1755, d. 1844)
- 3. Ball, Allen (b. 1689, d. 1761)
- sp. Harrison, Thomas (b. 1627 - England, d. 1704)
- 2. Harrison, Thomas (b. 1657, d. 1757)
- 2. Harrison, Nathaniel (b. 1658)

